

Waste Isolation Pilot Plant

Geotechnical Analysis Report For July 2010 – June 2011

U.S. Department of Energy

MAY 2012



This page intentionally left blank

This document has been submitted as required to:

U.S. Department of Energy
Office of Scientific and Technical Information
PO Box 62
Oak Ridge, TN 37831
(865) 576-8401

Additional information about this document may be obtained by calling 1-800-336-9477

Unlimited, publicly available full-text scientific and technical reports produced since 1991 are available online at Information Bridge (www.osti.gov/bridge).

U.S Department of Energy and its contractors may obtain full-text reports produced prior to 1991 in paper form for a processing fee from:

U.S. Department of Energy
Office of Scientific and Technical Information
P.O. Box 62
Oak Ridge, TN 37831-0062
Telephone: (865) 576-8401
Facsimile: (865) 576-5728
E-mail: reports@osti.gov

Available for sale to the public from:

U.S. Department of Commerce
National Technical Information Service
5301 Shawnee Rd
Alexandra, VA 22312
Phone: (800) 553-6847 or (703) 605-6000
Fax: (703) 605-6900
Email: info@ntis.gov

Working Copy

**Geotechnical Analysis Report for July 2010 – June 2011
DOE/WIPP-12-3484, Vol. 1**

This page intentionally left blank

FOREWORD AND ACKNOWLEDGMENTS

This report contains an assessment of the geotechnical status of the Waste Isolation Pilot Plant (WIPP). During the excavation of the principal underground access and experimental areas, the status was reported quarterly. Since 1987, when the initial construction phase was completed, reports have been published annually. This report presents and analyzes data collected from July 1, 2010, to June 30, 2011.

This Geotechnical Analysis Report (GAR) was written to meet the needs of several audiences. It satisfies requirements contained in the WIPP Hazardous Waste Facility Permit¹ (HWFP) and the Certification of Compliance² with Subparts B and C, Title 40 *Code of Federal Regulations* (CFR) Part 191, "Environmental Radiation Protection Standards for Management and Disposal of Spent Nuclear Fuel, High-Level and Transuranic Radioactive Wastes." It focuses on the geotechnical performance of the various components of the underground facility, including the shafts, shaft stations, access drifts, and waste disposal areas. The results of investigations of excavation effects and other geotechnical studies are also included.

The report compares the geotechnical performance of the repository to the design criteria. It describes the techniques that were used to acquire the data and the performance history of the instruments. The depth and breadth of the evaluation of the different components of the underground facility vary according to the types and quantities of data available and the complexity of the recorded geotechnical responses. Graphic documentation of data and tabular documentation of instrument history can be provided upon request.

This GAR was prepared by Washington TRU Solutions LLC (WTS) for the U.S. Department of Energy (DOE), Carlsbad Field Office (CBFO), in Carlsbad, New Mexico. Work was supported by the DOE under Contract No. DE-AC29-01AL66444.

¹ New Mexico Environment Department (NMED), 2010, Waste Isolation Pilot Plant Hazardous Waste Facility Permit, NM4890139088-TSDF, Santa Fe, NM

² U.S. Environmental Protection Agency, 1998, "Criteria for the Certification and Recertification of the Waste Isolation Pilot Plant's Compliance with the Disposal Regulations: Certification Decision," Federal Register, Vol. 63, No. 95, pp. 27354, May 18, 1998, Washington, DC

This page intentionally left blank

TABLE OF CONTENTS

ACRONYMS AND ABBREVIATIONS	13
1.0 INTRODUCTION	15
1.1 Location and Description	15
1.2 Mission.....	18
1.3 Development Status	18
1.4 Purpose and Scope of Geomechanical Monitoring Program	19
1.4.1 Instrumentation	20
1.4.2 Data Acquisition	21
1.4.3 Data Evaluation.....	22
1.4.4 Data Errors.....	23
2.0 GEOLOGY.....	23
2.1 Regional Stratigraphy	23
2.1.1 Permian.....	24
2.1.2 Triassic.....	27
2.1.3 Quaternary	27
2.2 Underground Facility Stratigraphy	28
2.2.1 Disposal Horizon Stratigraphy of Panels 1, 2, 7, and 8	28
2.2.2 Disposal Horizon Stratigraphy of Panels 3, 4, 5, and 6	29
2.2.3 Northeast Area Stratigraphy.....	32
3.0 PERFORMANCE OF SHAFTS AND KEYS.....	32
3.1 Salt Shaft	32
3.1.1 Shaft Observations.....	34
3.1.2 Instrumentation	34
3.2 Waste Shaft	37
3.2.1 Shaft Observations.....	39
3.2.2 Instrumentation	39
3.3 Exhaust Shaft	42
3.3.1 Exhaust Shaft Observations.....	42
3.3.2 Instrumentation	53
3.4 Air Intake Shaft	56
3.4.1 Shaft Performance	56
4.0 PERFORMANCE OF SHAFT STATIONS	58
4.1 Salt Shaft Station	58
4.1.1 Modifications to Excavation and Ground Control Activities	58
4.1.2 Instrumentation	58
4.2 Waste Shaft Station	61
4.2.1 Modifications to Excavation and Ground Control Activities	61
4.2.2 Instrumentation	63
4.3 Air Intake Shaft Station	65
4.3.1 Modifications to Excavation and Ground Control Activities	65
4.3.2 Instrumentation	65

Geotechnical Analysis Report for July 2010 – June 2011
DOE/WIPP-12-3484, Vol. 1

5.0	PERFORMANCE OF ACCESS DRIFTS	65
5.1	Modifications to Excavation and Ground Control Activities	65
5.2	Instrumentation	65
5.2.1	Extensometers	66
5.2.2	Convergence Points.....	66
5.3	Analysis of Convergence Point and Extensometer Data.....	70
5.4	Excavation Performance.....	75
6.0	PERFORMANCE OF WASTE DISPOSAL AREA	76
6.1	History.....	76
6.2	Modifications to Excavations and Ground Control Activities	77
6.3	Instrumentation	77
6.4	Excavation Performance.....	81
6.5	Analysis of Extensometer and Convergence Point Data	82
7.0	GEOSCIENCE PROGRAM	82
7.1	Observation Hole Inspections	83
7.2	Fracture Mapping.....	86
8.0	SUMMARY	87
9.0	REFERENCES	88

LIST OF TABLES

Table 1-1 – Geomechanical Instrumentation System.....	21
Table 3-1 – Water Removed from the Exhaust Shaft Catch Basin and the Interception Well System.....	49
Table 4-1 – Vertical Closure Rates in the Salt Shaft Station	61
Table 4-2 – Summary of Roof Extensometers in Waste Shaft Station	63
Table 4-3 – Closure Rates in the Waste Shaft Station	65
Table 5-1 – Summary of Modifications and Ground Control Activities in the Access Drifts July 1, 2010 through June 30, 2011.....	67
Table 5-1 – Summary of Modifications and Ground Control Activities in the Access Drifts July 1, 2010 through June 30, 2011.....	67
Table 5-2 – New and Replace Convergence Points Installed in the Access Drifts July 1, 2010 through June 30, 2011	68
Table 5-3 – Greater than 10 Percent Increases in Annual Vertical Convergence	73
Table 6-1 – Summary of Modifications and Ground Control Activities in the Waste Disposal Area from July 1, 2010 to June 30, 2011	77
Table 8-1 – Comparison of Excavation Performance to System Design Requirements	88

This page intentionally left blank

LIST OF FIGURES

Figure 1-1 – WIPP Location	16
Figure 1-2 – Underground Mining and Waste Disposal Configuration as of June 30, 2011	17
Figure 2-1 – Regional Geology	25
Figure 2-2 – Repository Level Stratigraphy of Panels 1, 2, 7, and 8	30
Figure 2-3 – Repository Level Stratigraphy of Panels 3, 4, 5, and 6	31
Figure 3-1 – Salt Shaft Stratigraphy	33
Figure 3-2 – Salt Shaft Instrumentation (Without Shaft Key).....	35
Figure 3-3 – Salt Shaft Key Instrumentation.....	36
Figure 3-4 – Waste Shaft Stratigraphy	38
Figure 3-5 – Waste Shaft Instrumentation (Without Shaft Key).....	40
Figure 3-6 – Waste Shaft Key Instrumentation.....	41
Figure 3-7 – Exhaust Shaft Stratigraphy	44
Figure 3-8 – Sample Intake of Exhaust Shaft Air Monitoring System.....	45
Figure 3-9 – Diagram of Exhaust Shaft Fixtures and Seepage Zones (Upper 200 ft).....	46
Figure 3-10 – Location of Interception Wells and Storage Containers	47
Figure 3-11 – Water Removed from the Exhaust Shaft Catch Basin and the Interception Well System	52
Figure 3-12 – Exhaust Shaft Instrumentation (Without Shaft Key)	54
Figure 3-13 – Exhaust Shaft Key Instrumentation	55
Figure 3-14 – Air Intake Shaft Stratigraphy	57
Figure 4-1 – Salt Shaft Station Stratigraphy	59
Figure 4-2 – Salt Shaft Station Instrumentation after Roof Beam Excavation	60
Figure 4-3 – Waste Shaft Station Stratigraphy.....	62
Figure 4-4 – Waste Shaft Station Instrumentation after Raising the Roof	64
Figure 5-1 – Typical Convergence Point Array Configurations Showing Anchor Designations	71
Figure 6-1 – Location of Panel 3 Geotechnical Instruments.....	78
Figure 6-2 – Location of Panel 4 Geotechnical Instruments.....	79
Figure 6-4 – Location of Panel 6 Geotechnical Instruments.....	81
Figure 7-1 – Example of Observation Hole Layout at Lower Horizon.....	84
Figure 7-2 – Example of Observation Hole Layout at Upper Horizon.....	85
Figure 7-3 – Typical Fracture Patterns at Lower Horizon	85
Figure 7-4 – Typical Fracture Patterns at Upper Horizon	86

This page intentionally left blank

ACRONYMS AND ABBREVIATIONS

ASTM	American Society for Testing and Materials
bp	before present
bsc	below shaft collar
CAO	Carlsbad Area Office
CBFO	Carlsbad Field Office
CFR	Code of Federal Regulations
CH	contact-handled
cm	centimeter(s)
DOE	U.S. Department of Energy
EPA	U.S. Environmental Protection Agency
ft	foot (feet)
GAR	Geotechnical Analysis Report
GIS	geomechanical instrumentation system
HWFP	Hazardous Waste Facility Permit
in	inch(es)
km	kilometer(s)
kPa	kilopascal(s)
kVA	kilovolt ampere(s)
LANL	Los Alamos National Laboratory
lb	pound(s)
m	meter(s)
Ma	million years
MB	marker bed
μin	10 ⁻⁶ inch(es)
NMED	New Mexico Environment Department
OMB	orange marker bed
psi	pound(s) per square inch
RH	remote-handled

SPDV Site and Preliminary Design Validation

TRU transuranic

WIPP Waste Isolation Pilot Plant

WTS Washington TRU Solutions LLC

yr(s) year(s)

1.0 INTRODUCTION

This Geotechnical Analysis Report (GAR) presents and interprets geotechnical data from the underground excavations at the Waste Isolation Pilot Plant (WIPP). The data, which are obtained as part of a regular monitoring program, are used to characterize conditions, to compare actual performance to the design assumptions, and to evaluate and forecast the performance of the underground excavations.

GARs have been available to the public since 1983. During the Site and Preliminary Design Validation (SPDV) Program, the architect/engineer for the project produced these reports quarterly to document the geomechanical performance during and immediately after early excavations of the underground facility. Since completion of the construction phase of the project in 1987, the management and operating contractor for the facility has prepared these reports annually. This report describes the performance and condition of selected areas from July 1, 2010, to June 30, 2011. It is divided into nine chapters.

Chapter 1 provides background information on WIPP, its mission, and the purpose and scope of the geomechanical monitoring program. Chapter 2 describes the local and regional geology of the WIPP site. Chapters 3 and 4 describe the geomechanical instrumentation in the shafts and shaft stations, present the data collected by that instrumentation, and provide interpretation of these data. Chapters 5 and 6 present the results of geomechanical monitoring in the two main portions of the WIPP underground (the access drifts and the waste disposal area). Chapter 7 discusses the results of the Geoscience Program, which include fracture mapping and observation hole observations. Chapter 8 summarizes the results of geomechanical monitoring and compares the current excavation performance to the design requirements. Chapter 9 lists references.

1.1 Location and Description

WIPP is located in southeastern New Mexico, 26 miles (42 kilometers [km]) east of Carlsbad (Figure 1-1). The surface facilities were built on the flat to gently rolling terrain that is characteristic of the Los Medaños area. The underground facility is being excavated approximately 2,150 feet (ft) (655 meters [m]) beneath the surface in the Salado Formation. Figure 1-2 shows a plan view of the underground configuration of WIPP as of June 30, 2011.

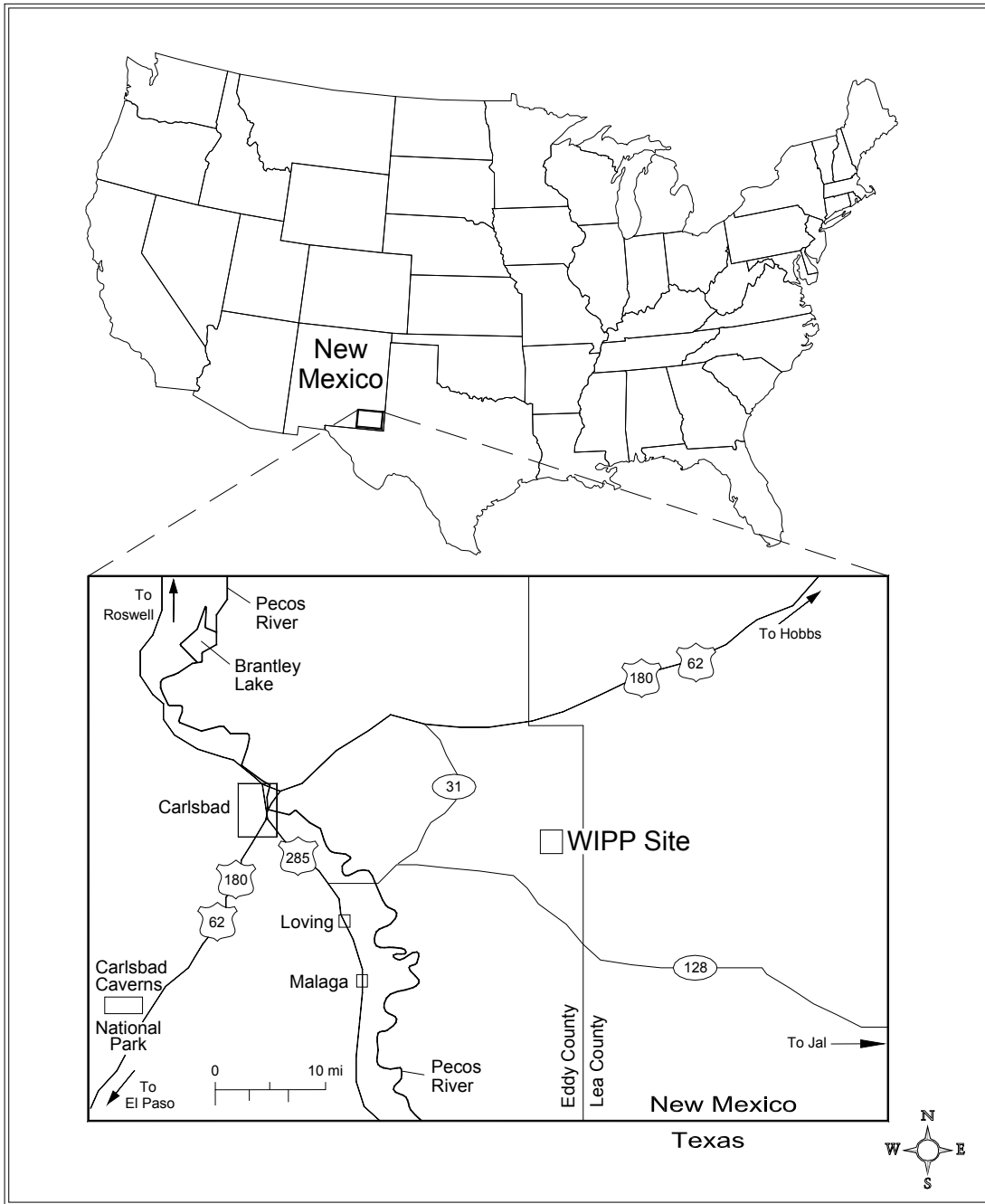

Figure 1-1 – WIPP Location

1.2 Mission

In 1979 Congress authorized WIPP (Public Law 96-164, National Security and Military Applications of Nuclear Energy Authorization Act of 1980) to provide ". . . a research and development facility to demonstrate the safe disposal of radioactive wastes resulting from the defense activities and programs of the United States exempted from regulation by the Nuclear Regulatory Commission." To fulfill this mission, the DOE constructed a full-scale facility to demonstrate both technical and operational principles of the permanent disposal of transuranic (TRU) and TRU mixed wastes. Technical aspects are those concerned with the design, construction, and performance of the subsurface excavations. Operational aspects refer to the receiving, handling, and emplacement of TRU wastes in the facility. The facility was first used for *in situ* studies and experiments without the use of radioactive waste. WIPP now receives handles, and permanently disposes of TRU waste and TRU mixed waste.

1.3 Development Status

To fulfill its mission, the DOE developed WIPP in a phased manner. The goal of the SPDV phase, begun in 1980, was to characterize the site and obtain *in situ* geotechnical data from underground excavations to determine whether site characteristics and *in situ* conditions were suitable for permanent disposal. During this phase, the Salt Shaft, a ventilation shaft, a drift to the southernmost extent of the proposed waste disposal area, a four-room experimental panel, and access drifts were excavated. Surface-based geological and hydrological investigations were also conducted. The data obtained from the SPDV investigations were reported in the "Summary of the Results of the Evaluation of the WIPP Site and Preliminary Design Validation Program" (DOE, 1983).

Based upon the favorable results of the SPDV investigations, additional activities were initiated in 1983. These included the construction of surface structures, conversion of the ventilation shaft for use as the Waste Shaft, excavation of the Exhaust Shaft, development of additional access drifts to the waste disposal area, excavation of the Air Intake Shaft, and excavation of additional experimental rooms to support research and development. Geotechnical data acquired during this phase were used to evaluate the performance of the excavations in the context of established design criteria (DOE, 1984). Results of these evaluations were reported in Geotechnical Field Data Reports (DOE, 1985; DOE, 1986a) and were summarized in the Design Validation Final Report (DOE, 1986b).

The Design Validation Final Report concluded that the facility, including waste disposal areas, could be developed and operated to fulfill the long-term mission of WIPP (DOE, 1986b). All available information validated the design of underground openings to safely accommodate the permanent disposal of waste under routine operating conditions.

Panel 1 mining began in 1986 and was completed in 1988. Panel 1 was intended to receive waste for an initial operations demonstration and pilot plant phase that was scheduled to start in October 1988; however, the demonstration and pilot plant phase was not put into effect because waste could not be emplaced until permits were acquired.

In October 1996, the DOE submitted to the U.S. Environmental Protection Agency (EPA) a compliance certification application in accordance with 40 CFR Parts 191 and 194, which addressed the long-term (10,000-year) performance criteria for the disposal system. On May 18, 1998, the EPA published the final certification that allowed for the receipt of TRU waste at WIPP. Immediately before this certification, the DOE Carlsbad Area Office (CAO) completed an Operational Readiness Review, which is required by the DOE before the start-up or a process change of any nuclear facility. As a result of the review, the CAO notified the Energy Secretary on April 1, 1998, that WIPP was operationally ready to receive waste. On March 26, 1999, the first shipment of TRU waste was received from Los Alamos National Laboratory (LANL). By the end of June 2011, many additional generator sites had shipped waste to WIPP. The cleanup of several small-quantity generator sites, as well as one large-quantity site (Rocky Flats Environmental Technology Site) is now complete.

Waste disposal in Panels 1, 2, 3, and 4 is complete. Panels 1, 2, and 3 contain only CH waste. The first RH waste shipment arrived January 24, 2007. Panel 4 was the first to receive both CH and RH waste. As of June 30, 2011, waste handling activities included RH disposal in Room 7 of Panel 6 and CH disposal in Room 1 of Panel 5. Mining of Panel 7 began April 24, 2010 and was ongoing as of June 30, 2011.

1.4 Purpose and Scope of Geomechanical Monitoring Program

As specified in the WIPP HWFP (NMED, 2010), the purpose of the geomechanical monitoring program is to obtain *in situ* data to support the continuous assessment of the design for underground facilities.

Specifically, the program provides for:

- Early detection of conditions that could affect operational safety.
- Evaluation of disposal room closure that ensures adequate access.
- Guidance for design modifications and remedial actions.
- Data for interpreting the behavior of underground openings, in comparison with the established design criteria.

Data taken by or input into the geomechanical instrumentation system (GIS) are evaluated and reported in this GAR. This annual report fulfills the requirements set forth in Part 4.6.1.2, Attachment A3, Section A2-5b (2) of the WIPP HWFP (NMED, 2010), and 40 CFR §191.14, "Assurance Requirements," implemented through the certification criteria, 40 CFR Part 194.

The Geomechanical Monitoring Program generates the data for four of the compliance monitoring parameters:

- Creep closure and stresses
- Extent of deformation
- Initiation of brittle deformation
- Displacement of deformation features

The instrumentation system for geomechanical monitoring provides data for routine evaluations of safety, stability, and performance of underground openings. *In situ* data are also used to model long-term disposal system performance. Changes resulting from excavations are monitored by routine inspections of selected observation hole arrays and fracture mapping to detect and quantify occurrences of discontinuities such as fractures and bed separations. Analysis of data indicating areas of potential instability allows timely corrective action before they could become safety issues. Other geoscience activities include geologic mapping and sampling, and seismic monitoring.

The GIS provides data that are collected, processed, and stored for analysis. The following subsections briefly describe the major components of the GIS.

1.4.1 Instrumentation

Instrumentation installed for measuring the geomechanical response of the shafts, drifts, and other underground openings includes convergence points, convergence meters, extensometers, rock bolt load cells, pressure cells, strain gauges, piezometers, and joint meters. Table 1-1 lists a summary of the specifications for geomechanical instrumentation.

Table 1-1 – Geomechanical Instrumentation System

Instrument Type	Measures	Range¹	Resolution¹
Sonic probe extensometer	Cumulative deformation	0–2 in	0.001 in
Convergence point (tape extensometer)	Cumulative deformation	2–50 ft	0.001 in
Wire convergence meter	Cumulative deformation	0–3.5 ft	0.001 in
Embedded strain gauge	Cumulative strain	0–3000 $\mu\text{in/in}$	1 $\mu\text{in/in}$
Spot-welded strain gauge	Cumulative strain	0–2500 $\mu\text{in/in}$	1 $\mu\text{in/in}$
Rock bolt load cell	Load	0–50 tons	40 lb
Earth pressure cell	Pressure	0–1000 psi	1 psi
Piezometer	Fluid pressure	0–500 psi	0.5 psi
Joint meter	Cumulative deformation	0–4 in	0.001 in
Vibrating wire extensometer	Cumulative deformation	0–4 in	0.001 in
Wire extensometer	Cumulative deformation	0–20 in	0.001 in
Linear potentiometric extensometer	Cumulative deformation	0–6 in	0.001 in

¹ Manual readout boxes for the instruments were manufactured to render measurements in U.S. customary units. Range and resolution measurement units have not been converted to metric units. Measurements from these instruments have been converted for presentation elsewhere in this report.

1.4.2 Data Acquisition

Geomechanical instruments are read either manually, using portable devices, or remotely by electronically polling the stations from the surface in accordance with approved operating procedures. Remotely read instruments are connected to one of the underground data loggers, and readings are collected by initiating the appropriate polling routine. Upon completion of a verification process, data are transferred to a computer database. Manual readout devices are taken to instrument locations underground. Data are recorded on data sheets and later entered into an electronic database.

The underground data acquisition system consists of instruments, polling devices, and a communications network. Instruments are connected to polling devices that are installed in electrical enclosures near the instrument locations. Polling devices are connected by a data link to a surface computer.

Whether acquired manually or remotely, geomechanical data are entered into the database files of the GIS data processing system. The data processing system consists of computer programs that are used to enter, reduce, and transfer the data to permanent storage files. Additional routines allow access to the permanent storage files for numerical analysis, tabular reporting, and graphical plotting. Copies of the instrumentation database and data plots are available upon request.³

³ Instrumentation data and data plots are presented in "Geotechnical Analysis Report for July 2010-June 2011 Supporting Data" (DOE/WIPP-12-3484 Volume 2). The document is available upon request from the National Technical Information Service. See page 3 for details and addresses.

1.4.3 Data Evaluation

Rounding and significant digits are used in the data tables of this document. The reference document is American Society for Testing and Materials (ASTM) document ASTM D 6026-06, "Standard Practice for Using Significant Digits in Geotechnical Data."⁴

Closure measurements are acquired manually from convergence point anchors and remotely from convergence meters. Data are presented in plots of closure versus time. Closure rate data are calculated and presented as part of the data analysis. Extensometers provide displacement data from instrumented rods or wires anchored at various depths. Plots show displacement versus time for individual anchors.

Displacement rate data from the hole collar to the deepest anchor are presented in the data analysis.

The annual closure rate is calculated as follows:

$$rate(inches / year) = (cfi_2 - cfi_1) / (date_2 - date_1) \times 365.25 \text{ days / year}$$

where cfi = the change from the initial reading (inches)

cfi_1 = cfi reading closest to the beginning of the reporting period

cfi_2 = cfi reading closest to the end of the reporting period

Comparisons between closure rates of the previous and current reporting periods are presented as percent changes in rate and are calculated as follows:

$$percent \ change \ in \ rate = ((Rate_{Current \ Period} - Rate_{Previous \ Period}) / (Rate_{Previous \ Period})) \times 100\%$$

Rock bolt load cells are used to determine bolt support performance. Plots show load versus time for each instrumented bolt.

Earth pressure cells and strain gauges are used to determine the stresses and deformation in and around the shaft liners. Data are depicted in time-based plots.

Piezometers are used to measure the gauge pressure of groundwater and are installed in the shafts at varying elevations to monitor the hydraulic head acting on the shaft liners. Data are plotted as pressure versus time.

Joint meters, installed perpendicular to a crack, monitor the dilation of the crack with time. Data are presented as displacement versus time.

⁴ Copyright by ASTM, Reproduction authorized per License Agreement with Washington TRU Solutions LLC.

1.4.4 Data Errors

GIS data are processed through a comprehensive database management system. Whether acquired manually or remotely, GIS data are processed and permanently stored according to approved procedures. On occasion, erroneous readings can occur. There are several possible explanations for erroneous readings, including the following:

- The measuring device was misread.
- The reading was recorded incorrectly.
- The measuring device was not functioning within specifications.

When a reading is believed to be erroneous, the suspect reading is evaluated, and, if necessary, a second reading is collected. If the second reading falls in line with the instrument trend, the first reading is discarded and the second reading is entered in the database. If the second reading and subsequent readings remain out of the instrument trend, the ground conditions in the vicinity of the instrument are assessed to determine the reason for the discrepancy. In addition, the reading frequency may be increased. This process to correct erroneous readings is documented, and the documentation is filed for future reference.

2.0 GEOLOGY

This chapter provides a summary of the stratigraphy of the WIPP region and the site. Readers desiring further geologic information may consult the "Geological Characterization Report, WIPP Site, Southeastern New Mexico" (Powers et al., 1978). This report was developed as a source document on the geology of the WIPP site for individuals, groups, or agencies seeking basic information on geologic history, hydrology, geochemistry, or detailed information, such as physical and chemical properties of repository rocks. A more recent survey of WIPP stratigraphy is included in Holt and Powers (1990).

2.1 Regional Stratigraphy

The stratigraphy in the vicinity of the WIPP site includes rocks of Permian (295 to 250 million years [Ma] before present [bp]), Triassic (250 to 203 Ma), and Quaternary (1.75 Ma to present) ages. The descriptions of formations provided in this section are given in order of deposition (oldest to youngest), beginning with the Castile Formation (Figure 2-1).

2.1.1 Permian

The Permian system in southwestern North America is divided into four series. The last of these, the Ochoan Series, contains the host rock in which the WIPP repository is located. The Ochoan Series is of mostly marine origin and consists of four formations: three evaporite formations (the Castile, the Salado, and the Rustler) and one redbeds formation (the Dewey Lake). The Ochoan evaporites overlie marine limestones and sandstones of the Guadalupian Series (Delaware Mountain Group). The younger redbeds represent a transition from the lower evaporite deposition to fluvial deposition on a broad, low-relief, fluvial plain. The Permian rocks are overlain by fluvial deposits of the Triassic and Quaternary periods.

2.1.1.1 Castile Formation

The Castile Formation, lowermost of the four Ochoan formations, is approximately 1,250 ft (380 m) thick in the WIPP vicinity. Lithologically, the Castile is the least complex of the evaporite formations and is composed chiefly of interbedded anhydrite and halite, with limestone present in minor amounts.

2.1.1.2 Salado Formation

The Salado Formation comprises nearly 2,000 ft (610 m) of evaporites, primarily halite. The formation is subdivided into three informal members: the unnamed lower member, the McNutt potash zone, and the unnamed upper member. Each member contains similar amounts of halite, anhydrite, and polyhalite and is differentiated on the basis of soluble potassium- and magnesium-bearing minerals. The WIPP disposal horizon is located within the unnamed lower member, 2,150 ft (655 m) below the surface.

2.1.1.3 Rustler Formation

The Rustler Formation is subdivided into five members, starting from its base: the Los Medaños Member, the Culebra Dolomite Member, the Tamarisk Member, the Magenta Dolomite Member, and the Forty-niner Member.

In the vicinity of the WIPP site, the Rustler is approximately 310 ft (95 m) thick and thickens to the east. The lower portion (Los Medaños Member) contains primarily fine sandstone to mudstone with lesser amounts of anhydrite, polyhalite, and halite. Bedded and burrowed siliciclastic sedimentary rocks with cross-bedding and fossil remains signify the transition from the strongly evaporitic environments of the Salado to the brackish lagoonal environments of the Rustler (Holt and Powers, 1990).

The upper portion of the Rustler contains interbeds of anhydrite, dolomite, and mudstone. The Culebra Dolomite member is generally brown, finely crystalline, and locally argillaceous. The Culebra contains rare to abundant vugs with variable gypsum and anhydrite filling and is the most transmissive hydrologic unit within the Rustler. The Tamarisk Member consists of lower and upper sulfate units separated by a unit that varies laterally from mudstone to mainly halite. The Magenta Dolomite Member is a gypsiferous dolomite with abundant primary sedimentary structures and well-developed algal features. The Forty-niner Member consists of lower and upper sulfate units separated by a mudstone that displays sedimentary features and bedding. East of the site area, halite correlates with the mudstone. The Culebra and Magenta Dolomite members are persistent and serve as important marker units.

2.1.1.4 Dewey Lake Redbeds

The Dewey Lake Redbeds is the uppermost of the Ochoan Series formations. Within the series, the Dewey Lake represents a transition from the lower marine evaporite deposition to fluvial deposition on a broad, low-relief, fluvial plain. The redbeds, approximately 475 ft (145 m) thick, consist of predominantly reddish-brown interbedded fine-grained sandstone, siltstone, and claystone. This formation is differentiated from others by its lithology and distinctive color (both of which are remarkably uniform), and by sedimentary structures, including horizontal- and cross-laminae and ripple marks. The redbeds also contain locally abundant greenish-gray reduction spots and

gypsum-filled fractures. The formation thickens from west to east due to eastward dips and erosion to the west.

2.1.2 Triassic

The only Triassic rocks present in the WIPP region belong to the Dockum Group.

2.1.2.1 Dockum Group

The Dockum Group consists of fine-grained floodplain sediments and coarse alluvial debris of Triassic age. From a pinch-out near the center of the WIPP site it thickens eastward, forming an erosional wedge. Local subdivisions of the Dockum Group are the Santa Rosa Sandstone and the Chinle Formation; however, only the Santa Rosa occurs in the vicinity of the site. It consists primarily of poorly sorted sandstone with conglomerate lenses and thin mudstone partings and contains impressions and remnants of fossils. These rocks have more variegated hues than the underlying uniformly colored Dewey Lake.

2.1.3 Quaternary

Quaternary Period deposits include the Gatuña Formation, Mescalero Caliche, and surficial sediments.

2.1.3.1 Gatuña Formation, Mescalero Caliche, and Surficial Sediments

The Gatuña Formation (ranging in age from approximately 1.3 million to 600,000 years bp) (Powers and Holt, 1993) is a stream-laid deposit overlying the Dockum Group in the WIPP vicinity. At the site center, the formation consists of approximately 13 ft (4 m) of poorly consolidated sand, gravel, and silty clay. The Gatuña Formation is light red and mottled with dark stains. The unit contains abundant calcium carbonate, but is poorly cemented. Sedimentary structures are abundant (Powers and Holt, 1993, 1995).

The Mescalero Caliche (approximately 500,000 years bp) is approximately 4 ft (1.2 m) thick in the WIPP vicinity. The Mescalero is a hard, resistant soil horizon that lies beneath a cover of wind-blown sand. The horizon is petrocalcic (i.e., very strongly cemented with calcium carbonate). Petrocalcic horizons form slowly beneath a stable landscape at the average depth of infiltration of soil moisture and indicate stability and integrity of the land surface. Many of the surface buildings at WIPP are founded on top of the Mescalero Caliche.

Surficial sediments include sandy soils developed from eolian material and active dune areas. The Berino Series (a soil type) covers about 50 percent of the site and consists of deep sandy soils that developed from wind-worked material of mixed origin. Based on sample analyses, the Berino soil from the WIPP site formed $330,000 \pm 75,000$ years bp.

2.2 Underground Facility Stratigraphy

The WIPP disposal horizon lies near the midpoint of the Salado Formation. The Salado was deposited in a shallow saline lagoon environment, which progressed through numerous inundation and desiccation cycles that are reflected in the formation. An "ideal" cycle progresses upward as follows: a basal layer consisting predominantly of claystone, followed by a layer of sulfate, which is in turn followed by a layer of halite. The entire sequence is capped by a bed of argillaceous (clay-rich) halite accumulated during a period of mainly subaerial exposure.

A regional system used for numbering the more significant sulfate beds within the Salado designates these beds as marker beds (MBs), counted from MB100 near the top of the formation to MB144 near the base. The repository is located between MB138 and MB139 (Figure 2-2) within a sequence of laterally continuous depositional cycles as described above. Within this sequence, layers of clay and anhydrite that are locally designated (as shown) can have a significant impact on the geomechanical performance of the excavations. Clay layers provide surfaces along which slip and separation can occur, whereas anhydrites form brittle layers that do not deform plastically.

In the vicinity of WIPP, the stratigraphy is fairly continuous and uniform. Beds generally dip toward the south-southeast at a slope of approximately 3 percent.

2.2.1 Disposal Horizon Stratigraphy of Panels 1, 2, 7, and 8

This disposal horizon contains Panels 1, 2, 7, and 8, all the shaft areas, the shop areas, the SPDV areas (which are now closed), and all the access drifts north of S-2620. Farther south, the four main entries rise in a ramp that starts at S-2620 and ends at S 2740. Panel 7 is currently being excavated, and Panel 8 has not yet been excavated.

Most underground excavations are located within this disposal horizon (Figure 2-2). In it, the Orange Marker Bed (OMB) lies near the middle of the rib (i.e., the excavation wall). The OMB is a laterally consistent unit of moderate to light reddish-orange translucent halite about 6 inches (in) (15 centimeters [cm]) thick that is used as a point of reference during excavation.

MB139 lies approximately 11.5 ft (3.5 m) below the OMB. MB139 is a 20 to 32 in (50-to-80 cm) thick layer of polyhalitic anhydrite. The top of the anhydrite undulates up to 15 in (38 cm), while the bottom is sub-horizontal and is underlain by Clay E.

Above MB139 is a unit of halite that terminates at the base of the OMB. Within this unit, polyhalite is locally abundant and decreases upward, while argillaceous material increases upward.

Above the OMB, a thin band of argillaceous halite gives way to a thick sequence of clear halite that becomes increasingly argillaceous upward and is capped by Clay F. This constitutes a thin layer occasionally interrupted by partings and breaks and is readily visible in the upper ribs. Above Clay F, another sequence of halite begins that, as in lower sequences, becomes increasingly argillaceous upward. This sequence terminates at the Clay G/Anhydrite "b" interface, approximately 6.5 ft (2 m) above the roof of most disposal horizon excavations, forming a roof beam that typically acts as a structural unit. The roof of some disposal horizon excavations (e.g., the E-140 drift between S-1000 and 1950), has been excavated to the upper contact of Anhydrite "b." In this case, a roof beam is formed by the next depositional sequence beginning with Anhydrite "b" and progressing upward to the Clay H/Anhydrite "a" interface, approximately 6.5 ft (2 m) above the upper contact of Anhydrite "b."

2.2.2 Disposal Horizon Stratigraphy of Panels 3, 4, 5, and 6

Field observations and computer modeling indicated that moving the disposal horizon stratigraphically upward (so that the roof was located at Clay G) would improve long-term ground conditions and provide a more stable roof configuration without significantly impacting repository performance. In 2000, the decision was made to implement this change by moving the mining horizon up approximately six feet. Subsequently, in 2000 and 2001, ramps were mined in the W 170, W 30, E 140, and E 300 drifts between S 2620 and S 2750 (Figure 1-2). As a result, the disposal horizon for Panels 3, 4, 5, and 6, and the associated connecting drifts lies above the horizon for the other panels (Figure 2-3).

**Geotechnical Analysis Report for July 2010– June 2011
DOE/WIPP-12-3484, Vol. 1**

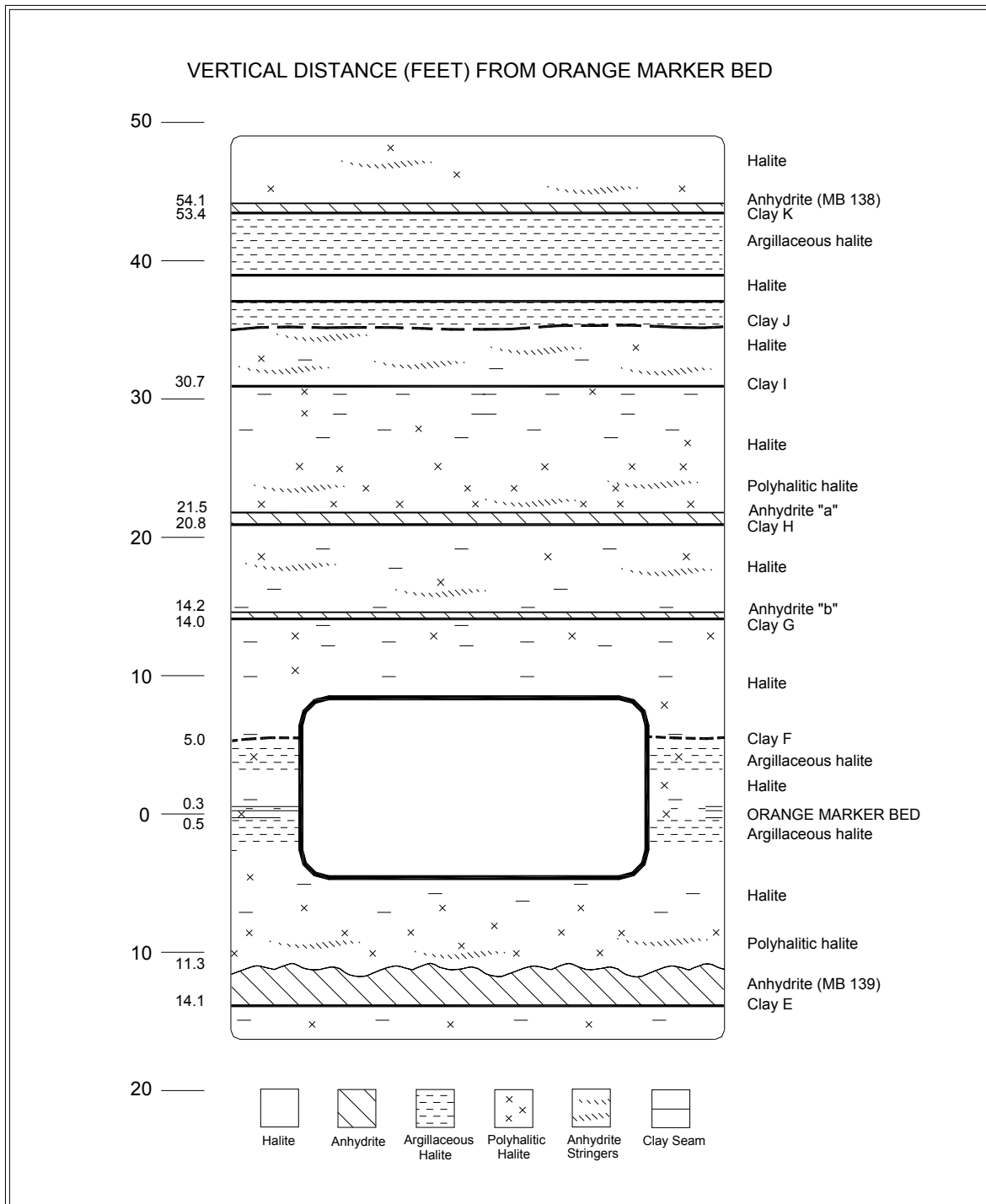

Figure 2-2 – Repository Level Stratigraphy of Panels 1, 2, 7, and 8

In this horizon (see Figure 2-3), the OMB lies at or below the floor. MB139 lies about 12 ft (3.7 m) below the floor. The roof lies at or slightly above Anhydrite "b." Clay G/ Anhydrite "b" is used as the mining reference during excavation of this disposal horizon.

**Geotechnical Analysis Report for July 2010– June 2011
DOE/WIPP-12-3484, Vol. 1**

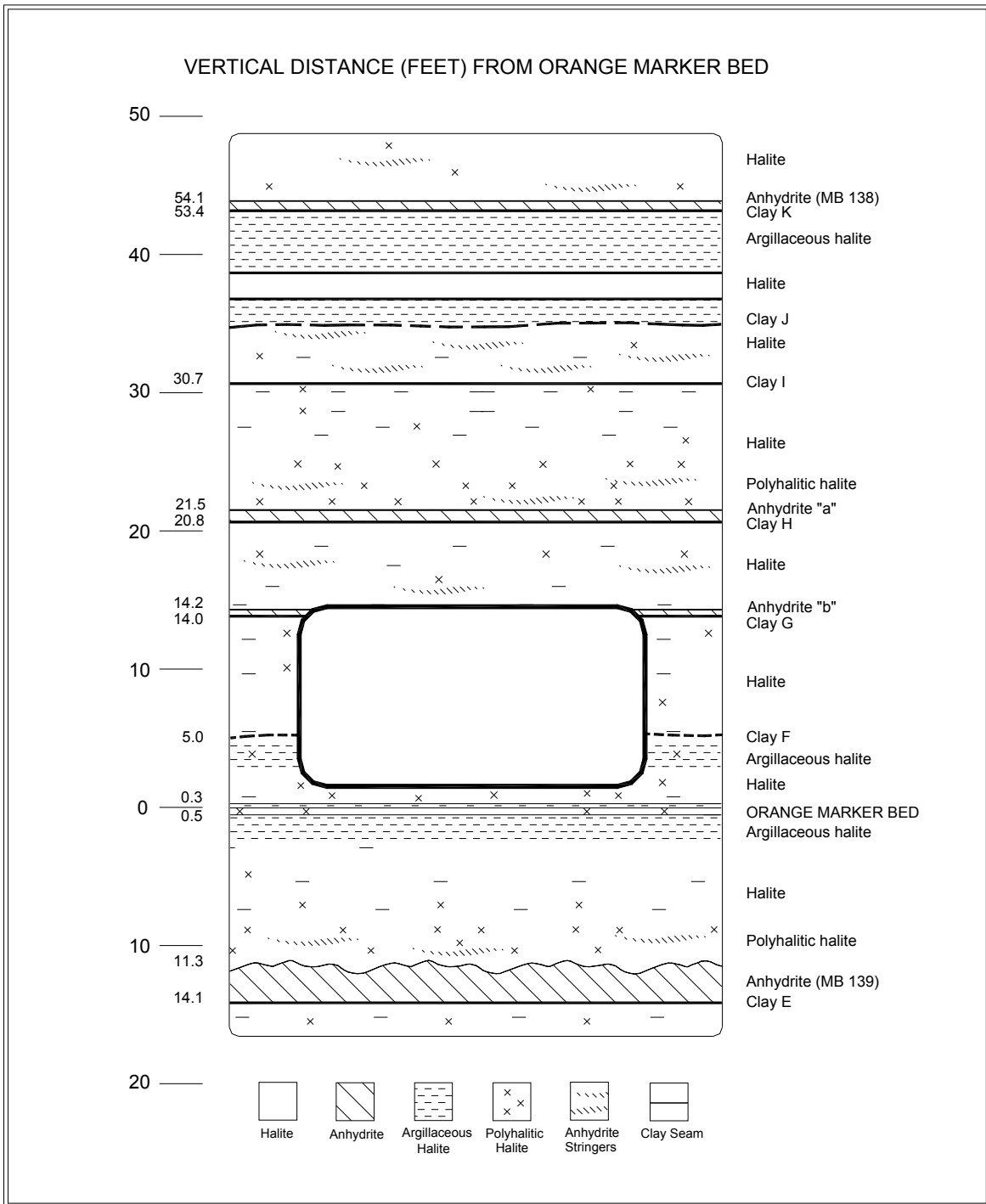

Figure 2-3 – Repository Level Stratigraphy of Panels 3, 4, 5, and 6

2.2.3 Northeast Area Stratigraphy

All of the Northeast Area, a former experimental area, is now deactivated and closed to access. These excavations lie at a higher stratigraphic level than the disposal excavations. Floors are at Anhydrite "b." As in the lower units, the halite intervals between the clay seams/anhydrite beds contain relatively pure halite that becomes increasingly argillaceous upward. Above clay I, two more halite intervals complete the underground facility stratigraphy. Clay J, at the top of the first of these intervals, may consist of a distinct seam or merely an argillaceous zone. Clay K tops the second interval and is overlain by MB138.

3.0 PERFORMANCE OF SHAFTS AND KEYS

Four shafts connect the surface with the underground. They are the Salt Shaft, which is used primarily for removing excavated salt from the underground and for transporting personnel and material; the Waste Shaft, which is used primarily for transporting TRU waste to the underground and for transporting personnel and materials; the Exhaust Shaft, which is used to exhaust the ventilation air from the underground; and the Air Intake Shaft, which is the primary source of fresh air ventilation to the underground. This chapter describes the geomechanical performance of these shafts.

Although through the years much of the instrumentation installed in the shafts has failed, there are no plans to replace it. The project has a good understanding of the expected movements in the shafts. Monitoring results up to the point of instrument failure did not indicate unusual shaft movements or displacements. Continued periodic visual inspections confirm the expected shaft performance and provide necessary observations to evaluate shaft performance. Replacement of failed instrumentation will not provide significant additional information.

3.1 Salt Shaft

The first construction activity undertaken during the SPDV Program was the excavation of the Exploratory Shaft. This shaft was subsequently referred to as the Construction and Salt Shaft and is currently designated the Salt Shaft (see Figure 1-2). The shaft was drilled from July 4 to October 24, 1981, and geologically mapped in the spring of 1982 (DOE, 1983). Figure 3-1 presents the stratigraphy in the shaft.

The Salt Shaft is lined from the surface to 846 ft (258 m) with steel casing having an inside diameter of 10 ft (3-m). The thickness of the steel liner (including external stiffener rings) increases from 0.62 in (1.6 cm) at the top to 1.5 in (3.8 cm) at the key. Cement grout was placed between the liner and the rock face. The 10-ft (3-m) diameter extends through the concrete shaft key to 880 ft (268 m). The shaft key is a 37.5 ft (11.4-m) long, reinforced-concrete structure that begins 3.5 ft (1.07 m) above the bottom of the steel liner. From the key to the bottom at 2,298 ft (700 m), the shaft has a nominal diameter of 12 ft (4 m).

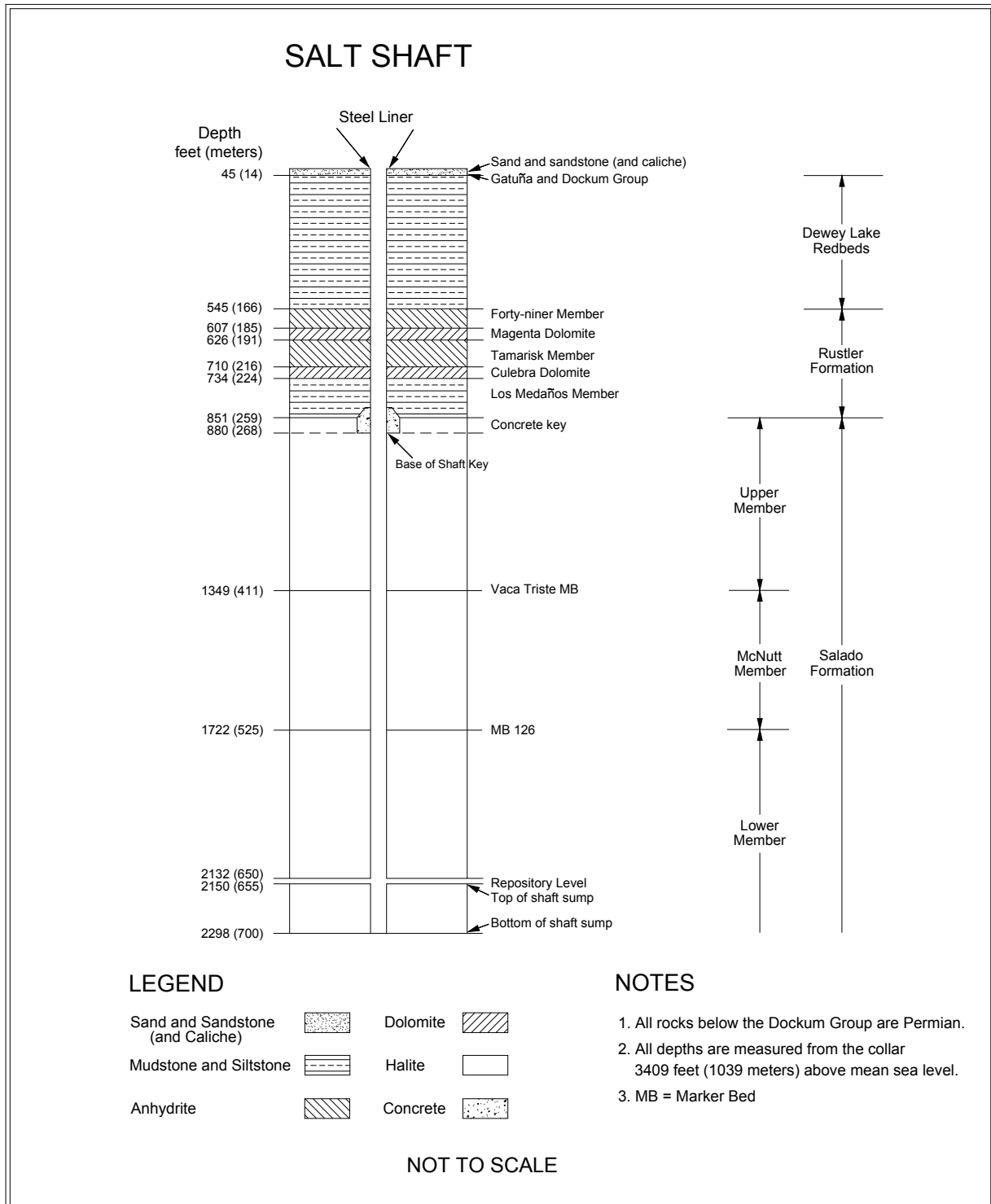

Figure 3-1 – Salt Shaft Stratigraphy

Wire mesh anchored by rock bolts is installed in sections of the lower shaft as a safety screen to contain rock fragments that may become detached. The shaft extends approximately 140 ft (43 m) below the repository horizon in order to accommodate the skip loading equipment and a sump.

3.1.1 Shaft Observations

Underground operations personnel conduct weekly visual inspections. These inspections are performed principally to assess the condition of the hoisting and mechanical systems, but they also include examining the shaft walls for water seepage, loose rock, or sloughing. Visual inspections during this reporting period found that the shaft remained in satisfactory condition. Only routine ground control activities were required.

3.1.2 Instrumentation

Geomechanical instruments (radial convergence points, extensometers, and piezometers) were installed at various levels in the shaft from April through July of 1982 (Figure 3-2). In the shaft key, instruments included strain gauges, pressure cells, and piezometers. Radial convergence points were installed prior to outfitting. Upon completion of shaft outfitting, no more readings were taken. Figure 3-2 and Figure 3-3 show the instrument locations.

Ten of the 12 piezometers continue to provide data. The fluid pressures recorded at the end of this reporting period range from approximately 60 pounds per square inch (psi) (414 kilopascals [kPa]) at the 802-ft (244-m) level in the Los Medaños Member to 188 psi (1,296 kPa) at the 691-ft (211-m) level in the Magenta Dolomite Member. The recorded pressures for this reporting period are generally consistent with the readings from the previous reporting period. The fluid pressure on the shaft liner will continue to be monitored on a regular basis.

Four earth pressure cells were installed in the key section during concrete emplacement at the 860-ft (262-m) level. These instruments measure the normal stress between the concrete key and the Salado Formation as salt creep loads up the key structure. Three of the four earth pressure cells continue to provide data. These instruments have indicated essentially no contact pressure since their installation (readings resemble instrument drift at a zero pressure). The maximum contact pressure recorded by the instruments for this reporting period is 7 psi (48 kPa).

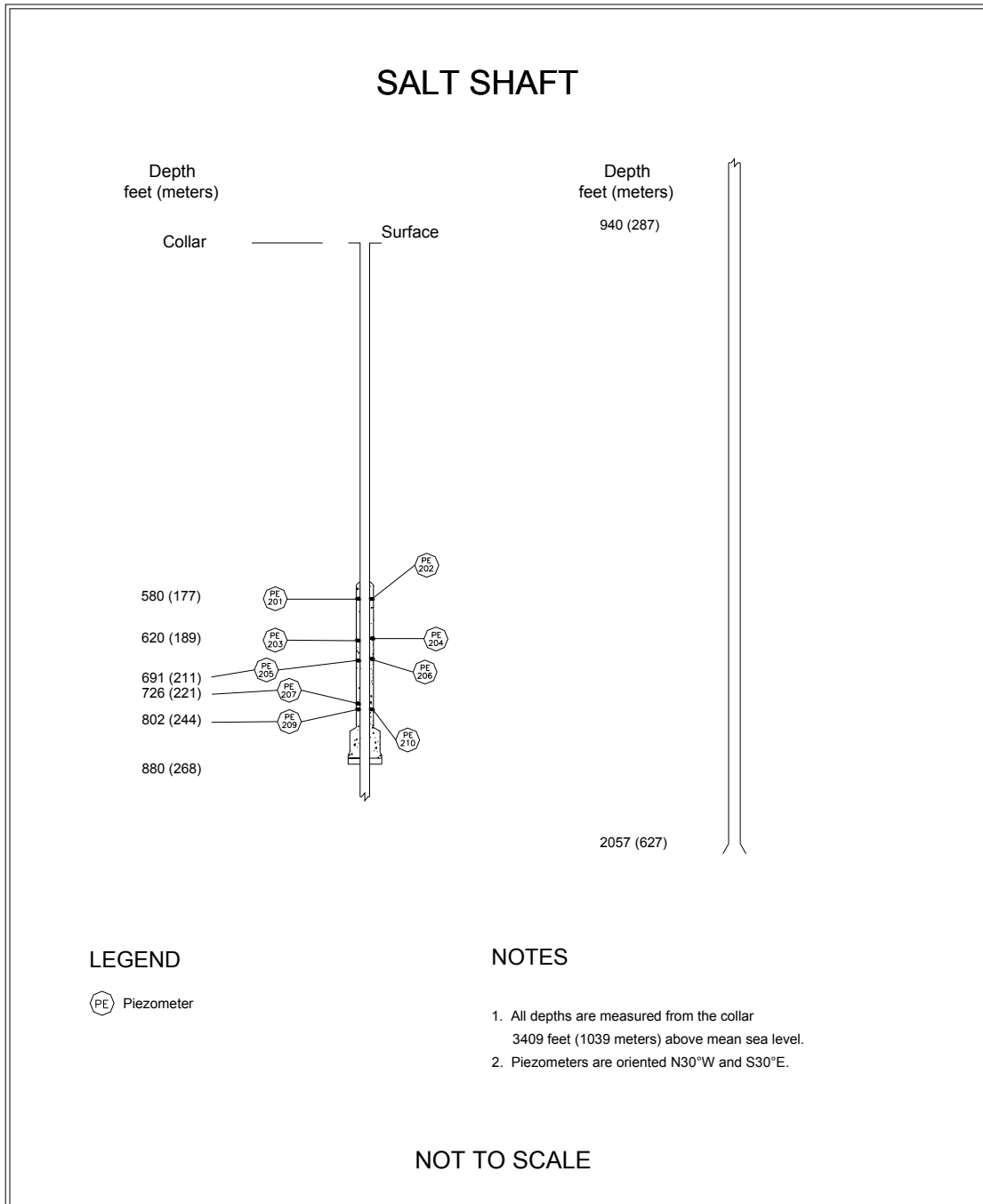

Figure 3-2 – Salt Shaft Instrumentation (Without Shaft Key)

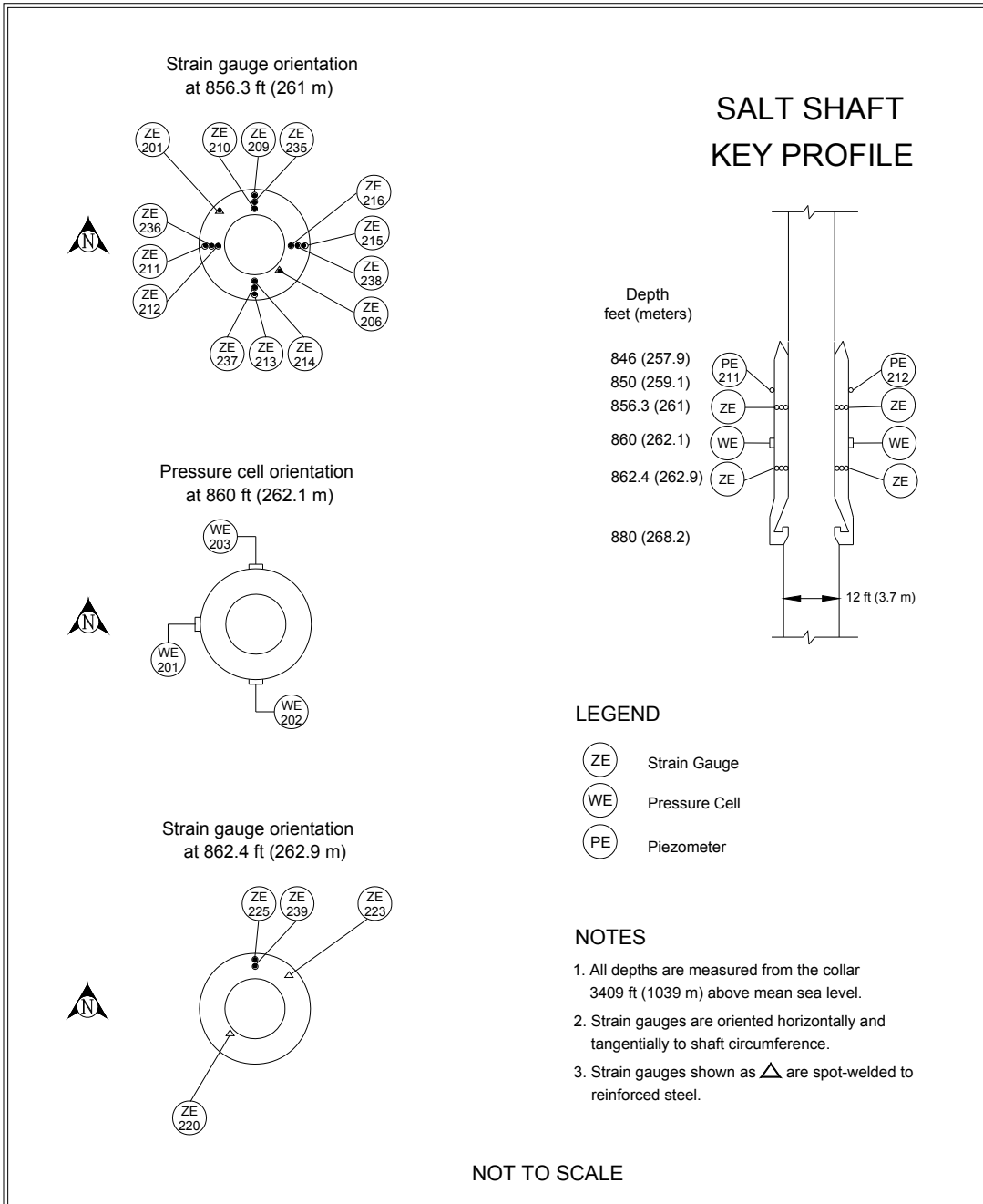

Figure 3-3 – Salt Shaft Key Instrumentation

Sixteen spot-welded and twenty-four embedment strain gauges were installed on and in the shaft key concrete at both the 856.3-ft (261-m) level and at the 862.4-ft (263-m) level. Four spot-welded strain gauges are still functioning at these levels. Strains at the 856.3-ft (261-m) level were 653 and 746 microstrain. Strains at the 862.4 ft (263 m) level were 705 and 906 microstrain. Fourteen embedment strain gauges are still functioning. The strains at the 856.3-ft (261-m) level ranged from -891 to 998 microstrain. The strains from the two embedment strain gauges at the 862.4 ft (263-m) level were 271 to 391 microstrain. The strains recorded by the spot-welded strain gauges and the embedment strain gauges during this reporting period are very similar to the strains recorded by these instruments at the end of the previous reporting period.

3.2 Waste Shaft

As part of the SPDV Program, a 6-ft (2-m) diameter ventilation shaft, now referred to as the Waste Shaft, was excavated from December 1981 through February 1982 (see Figure 1-2). This shaft, in combination with the Salt Shaft, provided a two-shaft underground air circulation system. From October 11, 1983, to June 11, 1984, the shaft was enlarged to a diameter of 20 to 23 ft (6 to 7 m) and lined above the key. Stratigraphic mapping (Figure 3-4) was conducted during shaft enlargement from December 9, 1983, to June 5, 1984 (Holt and Powers, 1984).

The Waste Shaft is lined with non-reinforced concrete having a 19 ft (6 m) inside diameter from the surface to the top of the key at 837 ft (255 m). Liner thickness increases from 10 in (25 cm) at the surface to 20 in (51 cm) at the key. The key is 63 ft (19 m) long and 4.25 ft (1.3 m) thick and is constructed of reinforced concrete. The bottom of the key is 900 ft (274 m) below the surface. The diameter of the shaft is 20 ft (6 m) at the bottom of the key and increases to 23 ft (7 m) just above the shaft station. The shaft below the key is lined with wire mesh anchored by rock bolts. The diameter of 23 ft (7 m) extends to a depth of approximately 2,286 ft (697 m), with the shaft sump comprising the lower 119 ft (36 m) of that interval.

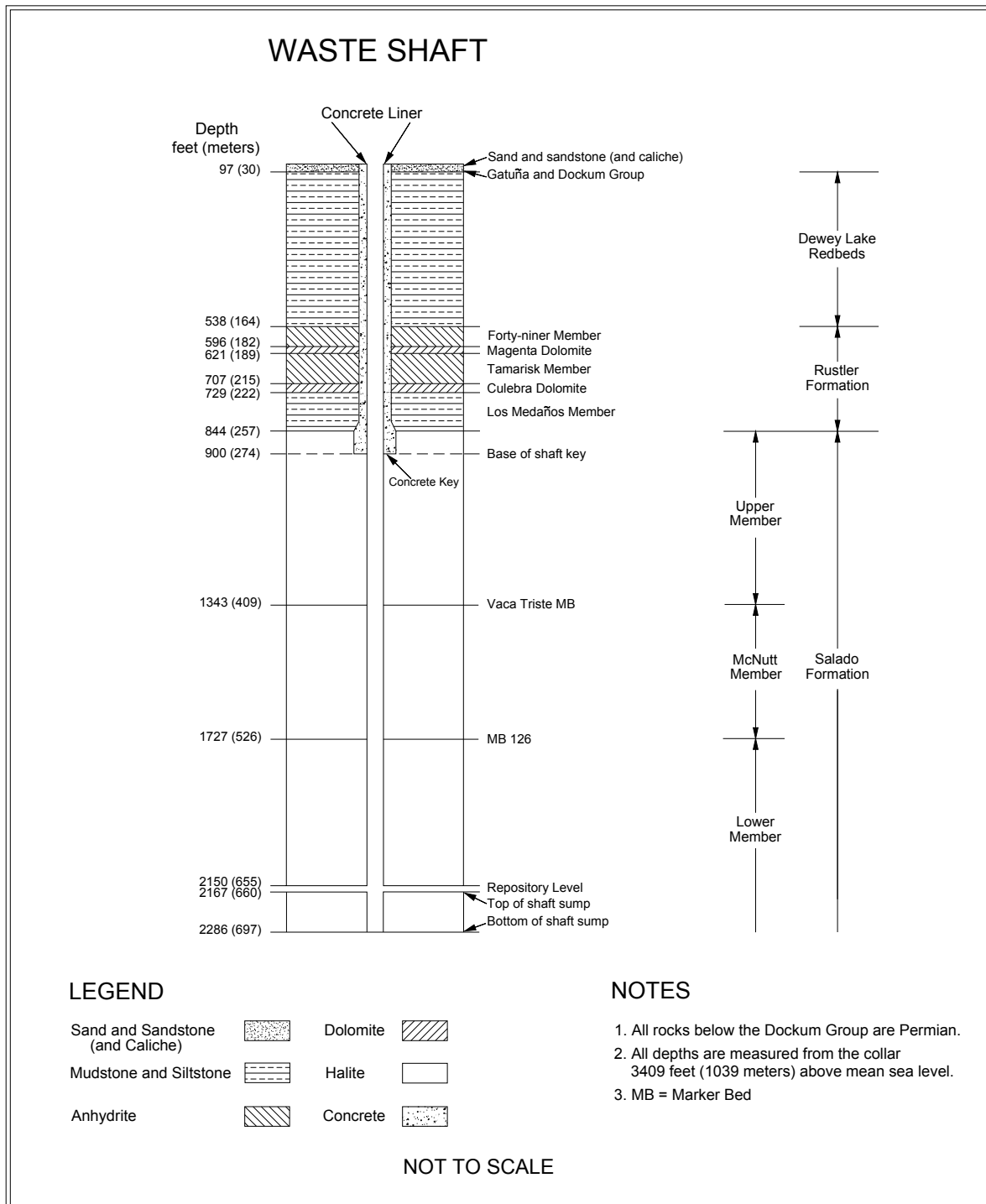

Figure 3-4 – Waste Shaft Stratigraphy

3.2.1 Shaft Observations

Underground operations personnel conduct weekly visual inspections, principally to assess the condition of the hoisting and mechanical systems, but also include observation of the shaft walls for water seepage, loose rock, or sloughing. The visual inspections found that the shaft was in satisfactory condition. No ground control activities other than routine maintenance were required.

3.2.2 Instrumentation

Radial convergence points, extensometers, piezometers, and earth pressure cells were installed in the Waste Shaft between August 27 and September 10, 1984. Radial convergence points were installed prior to the outfitting. Upon completion of shaft outfitting, no more radial convergence readings were taken. Figure 3-5 and Figure 3-6 show the instrument locations.

Nine multi-position extensometers were installed in arrays 1,071 ft (326 m), 1,566 ft (477 m), and 2,059 ft (628 m) below the surface as shown in Figure 3-5. Each array consists of three extensometers. No extensometer data have been collected in recent years due to the malfunction of the data acquisition equipment. Since the type of extensometers installed in the shaft over 27 years ago is no longer manufactured, remote data acquisition equipment for these extensometers is also unavailable.

Twelve piezometers were installed in the lined section of the Waste Shaft on September 7 and 8, 1984, to monitor fluid pressure behind the shaft liner and the key section. Data continue to be received from 4 piezometers. The maximum recorded fluid pressure during this reporting period was 138 psi (951 kPa) at the 717-ft (219-m) level. The pressure readings during this reporting period were consistent with the readings from the previous reporting period with a mean change in pressures of 5 psi (34 kPa).

Four earth pressure cells were installed in the key section of the Waste Shaft during concrete emplacement between March 23 and April 3, 1984. One is still working. Earth pressure cells measure the normal stress between the concrete key and the Salado Formation as salt creep loads the key structure. The contact pressure recorded by the instrument during this reporting period was 118 psi (814 kPa) at the 866 ft (264 m) level.

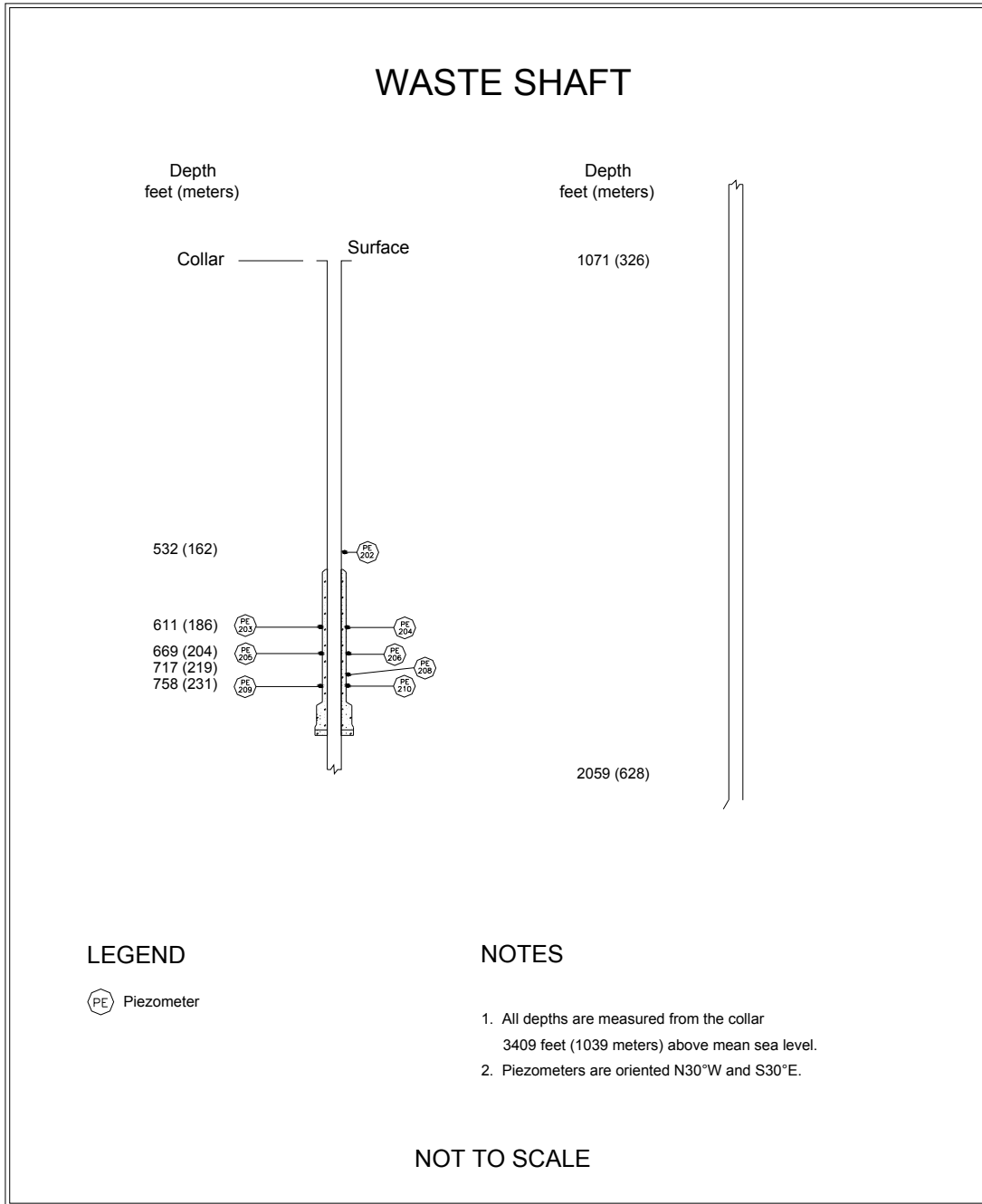

Figure 3-5 – Waste Shaft Instrumentation (Without Shaft Key)

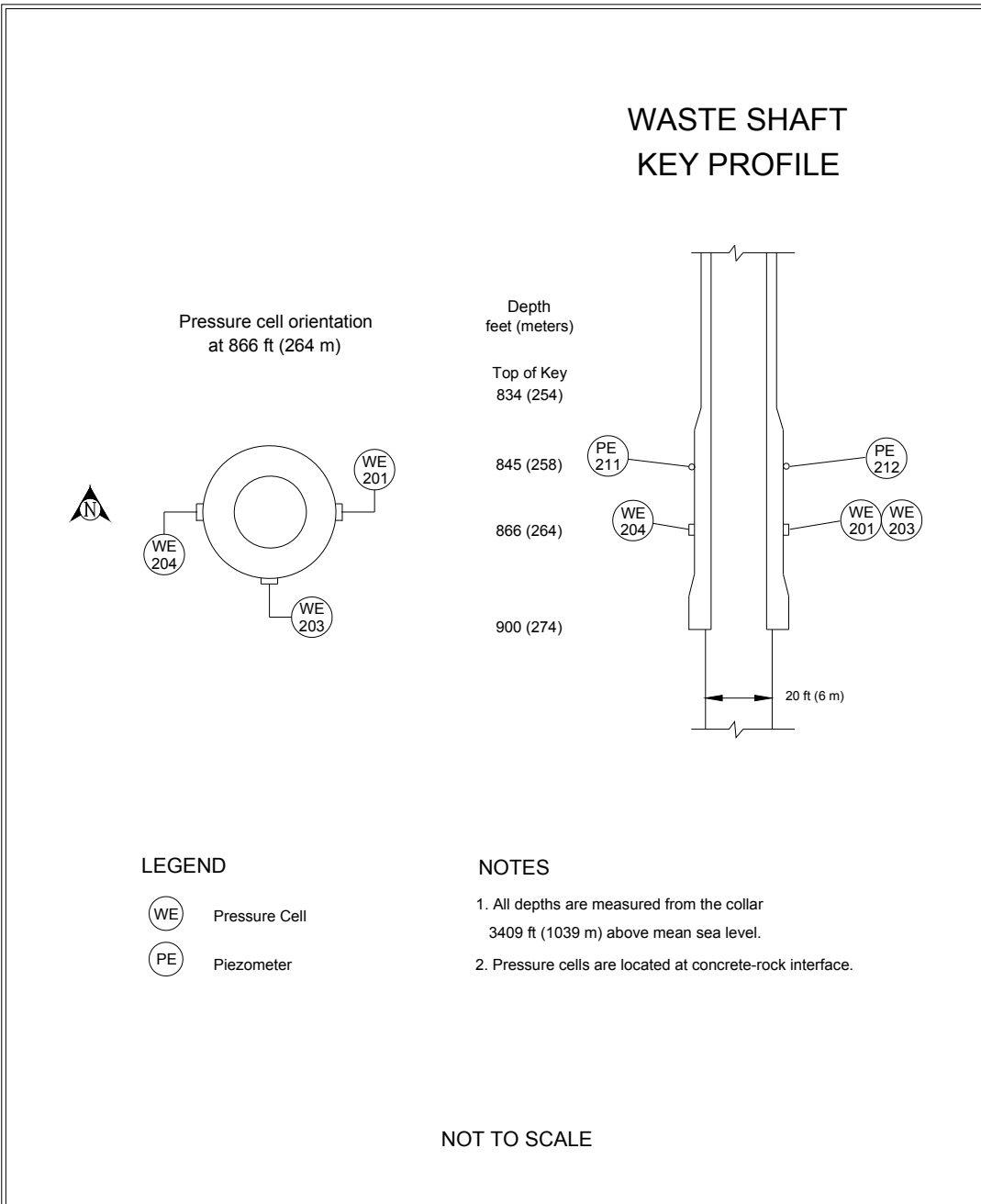

Figure 3-6 – Waste Shaft Key Instrumentation

3.3 Exhaust Shaft

The Exhaust Shaft was drilled from September 22, 1983, to November 29, 1984, to establish a route from the underground to the surface for exhaust air (Figure 1-2). Stratigraphic mapping was conducted from July 16, 1984, to January 18, 1985 (DOE, 1986c). Figure 3-7 illustrates the shaft stratigraphy.

The Exhaust Shaft is lined with non-reinforced concrete from the surface to the top of the shaft key at 844 ft (257 m). The liner thickness increases from 10 to 16 in (25 to 41 cm) over that interval. The key is 63 ft (19 m) long and 3.5 ft (1 m) thick. The shaft diameter below the key is 15 ft (5 m), and the interval below the key is lined with wire mesh anchored by rock bolts. The shaft terminates at the facility horizon, approximately 2,150 ft (655 m) deep. This shaft has no sump.

3.3.1 Exhaust Shaft Observations

Quarterly video inspections were conducted according to approved WIPP procedures. Inspections were performed to evaluate the condition and to verify the integrity of the shaft. The shaft was examined for cracks, corrosion, salt buildup, seeps, and debris. In addition, inspections examined the condition of anchors, brackets, and down-hole equipment. Between July 2010 and June 2011, four quarterly shaft inspections were conducted on August 4, 2010; November 17, 2010; February 16, 2011; and May 18, 2011.

3.3.1.1 Video Camera

Video inspections use a custom-designed vertical-drop color camera in an aerodynamic housing, suspended by a dual-armored cable, with pan, tilt, and zoom capability. The cable contains five copper conductors and two multi-mode optical fibers. It is reeled out by a winch mounted in a control van. Inspections are recorded electronically.

3.3.1.2 Shaft Inspection Observations

Quarterly video inspection observations concentrate on four major areas: air monitoring components, shaft liner, shaft walls, and equipment support and cabling. The air monitoring components consist of one air-velocity and three air-monitoring devices as shown in Figure 3-8. The video inspection includes examination of each device, including the transport assembly, guide tubes, the sample intake, and the support brackets that extend from Station "A" above the shaft to the shaft collar. Air monitoring components extend from the collar 21 ft into the shaft. Video inspections indicate that the air-sampling components can accumulate salt buildup of up to several inches thick.

The Exhaust Shaft liner is examined for cracks, seepage, and general shaft stability. Currently, there are three principal zones of seepage in the shaft. The first is about 50 to 55 ft below the shaft collar (bsc). The second is about 60 to 65 ft bsc. The third is

about 75 to 80 ft bsc, as shown in Figure 3-9. Monitoring of seepage horizons started before 1995. Water entering the shaft through these cracks is believed to originate from a perched aquifer at the base of the Santa Rosa Formation that is being recharged as the result of surface modifications at the site. The fluid level in the Santa Rosa near the shaft is about 46 to 47 ft below the surface. Based on examination of inspection videos, the flow rate into the shaft during this reporting period is estimated at about 1 to 1 1/2 gallons per minute, most of which is carried out of the shaft by the exhaust air. Seepage cracks are confined primarily to the eastern side of the shaft wall.

When fluid was detected seeping into the shaft, a catch basin was designed and installed at the base of the Exhaust Shaft to intercept water and prevent it from draining into the Waste Shaft Sump. Fluid was removed from the catch basin from March 1996 through October 2005 as needed. The catch basin was damaged in 2004 by fallen debris, either salt or instrumentation cables or both. A new catch basin was fabricated and installed in December 2004. This basin was damaged in August 2005, most likely the result of fallen debris. An interception well system was installed between November 2005 and March 2006 to replace the catch basin. Interception wells were drilled down-gradient in S-400 between E-140 and E 300 (Figure 3-10). The interception well system initially consisted of four 30-ft deep 9-7/8-in diameter fluid collection holes with a submersible pump and pressure transducer in each. Fluid is pumped from each hole to a series of storage containers in S-550. A data-acquisition system monitors the fluid level in each hole, turning the pump on and off between set limits as needed.

Between February 2 and 6, 2008, two additional fluid collection holes, OH631 and OH632, were drilled in S-400 to improve the total volume of fluid recovered by the interception well system. They replaced OH613 and OH614 which generated little fluid. As with the previous four holes, the additional holes were drilled at 9-7/8-inch diameter to a total depth of 30 feet. Pumps were pulled from OH613 and OH614 and installed in OH631 and OH632. Figure 3-10 shows the location of the interception wells system and the 500-gallons storage containers.

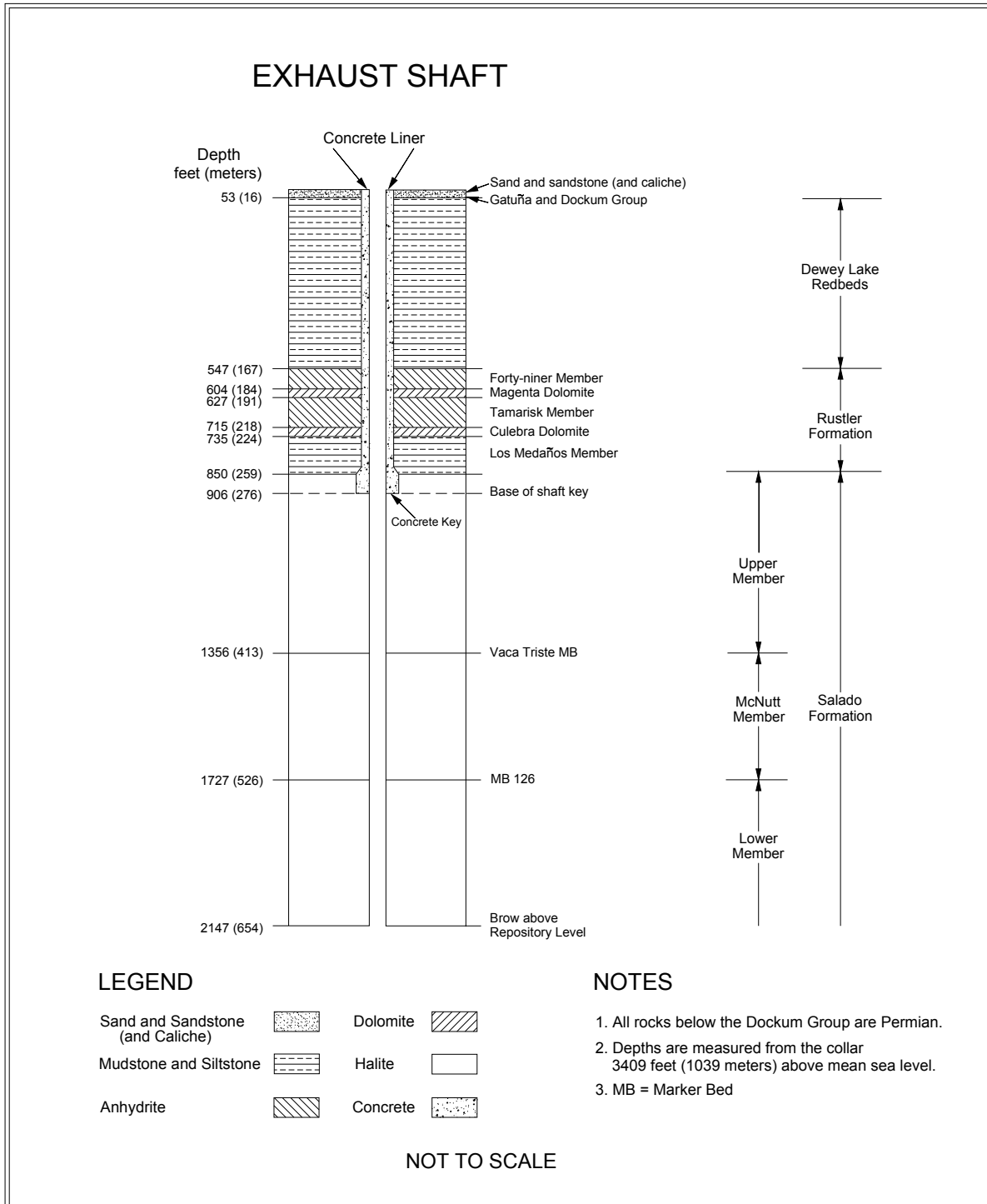

Figure 3-7 – Exhaust Shaft Stratigraphy

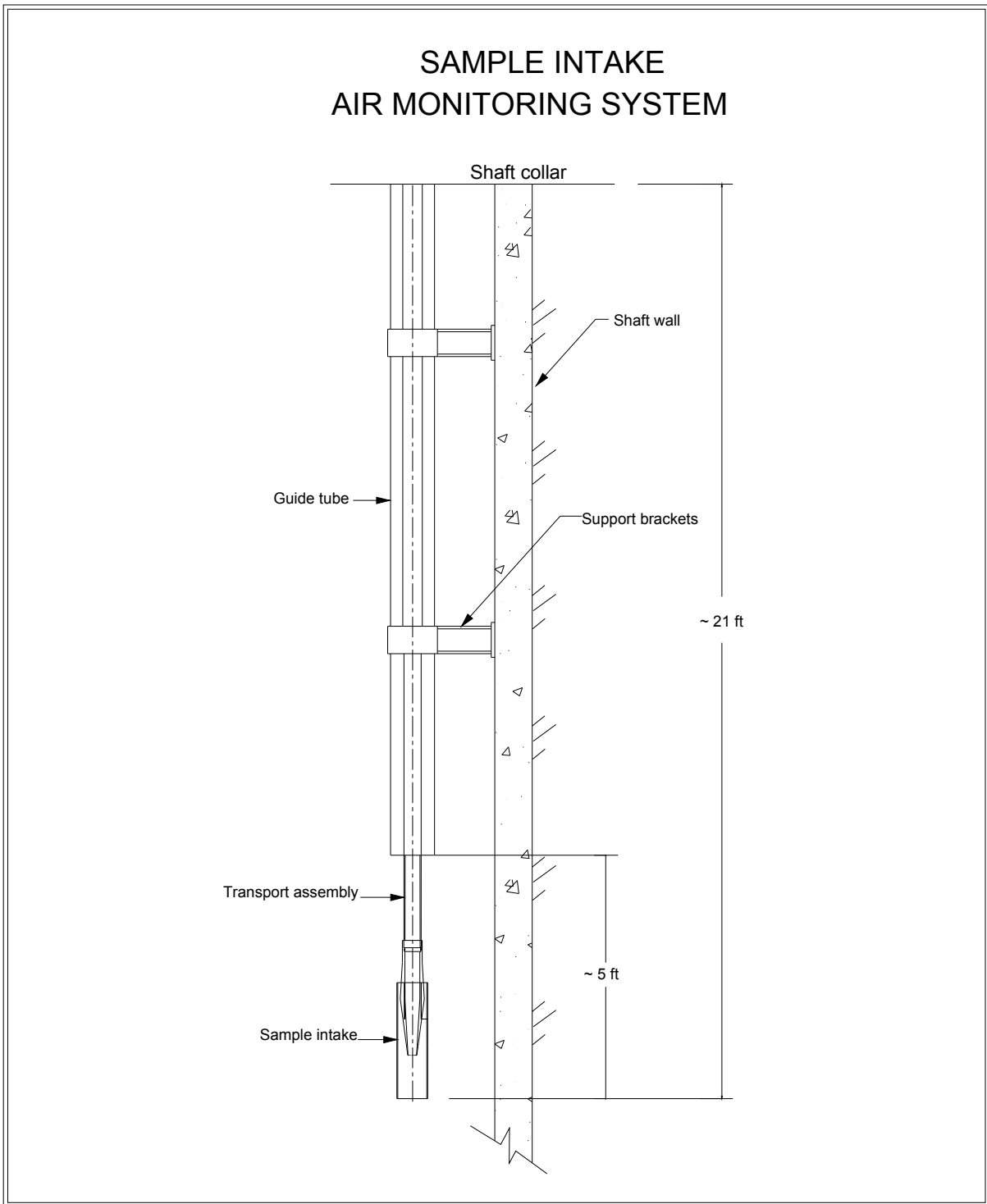

Figure 3-8 – Sample Intake of Exhaust Shaft Air Monitoring System

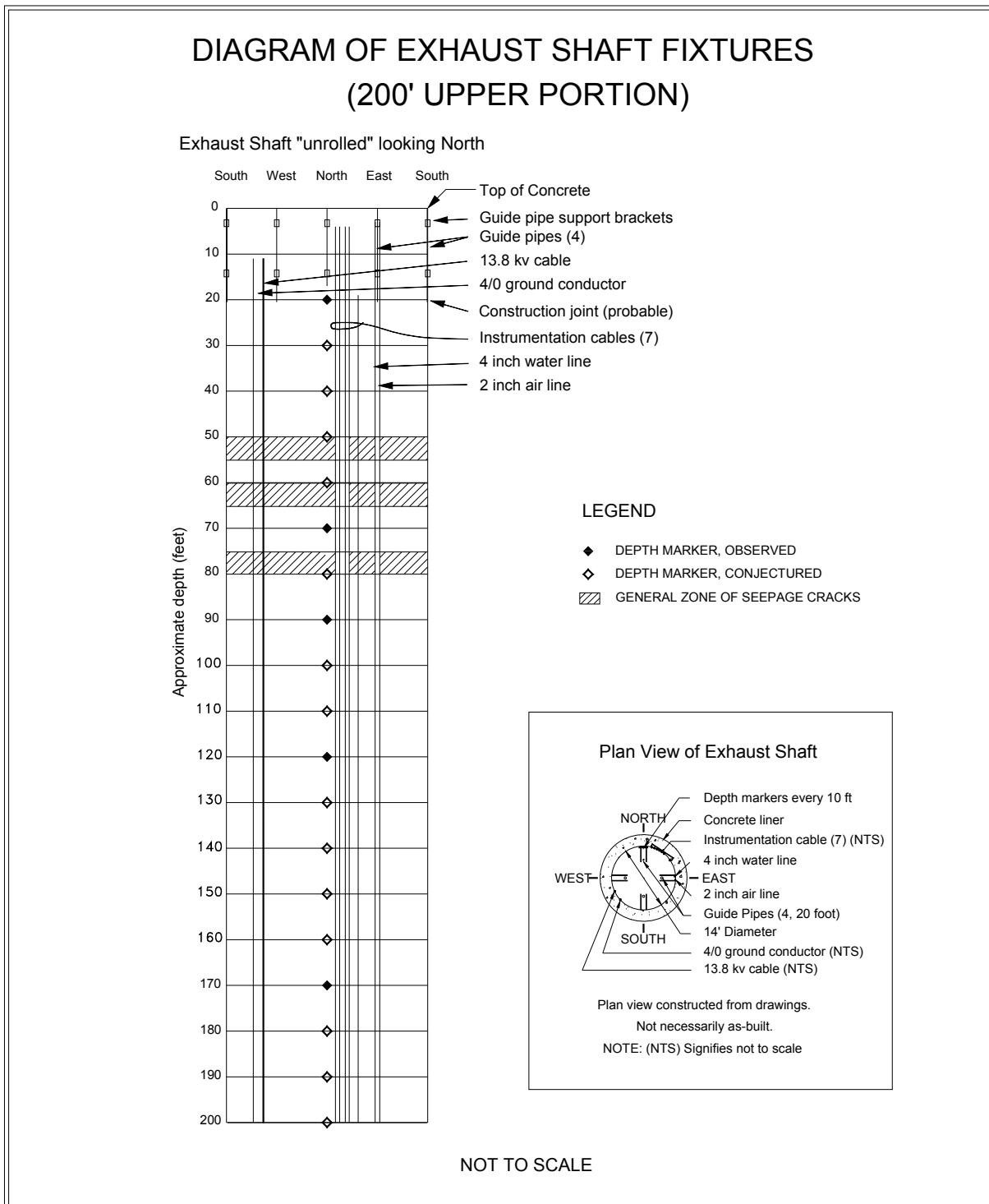

Figure 3-9 – Diagram of Exhaust Shaft Fixtures and Seepage Zones (Upper 200 ft)

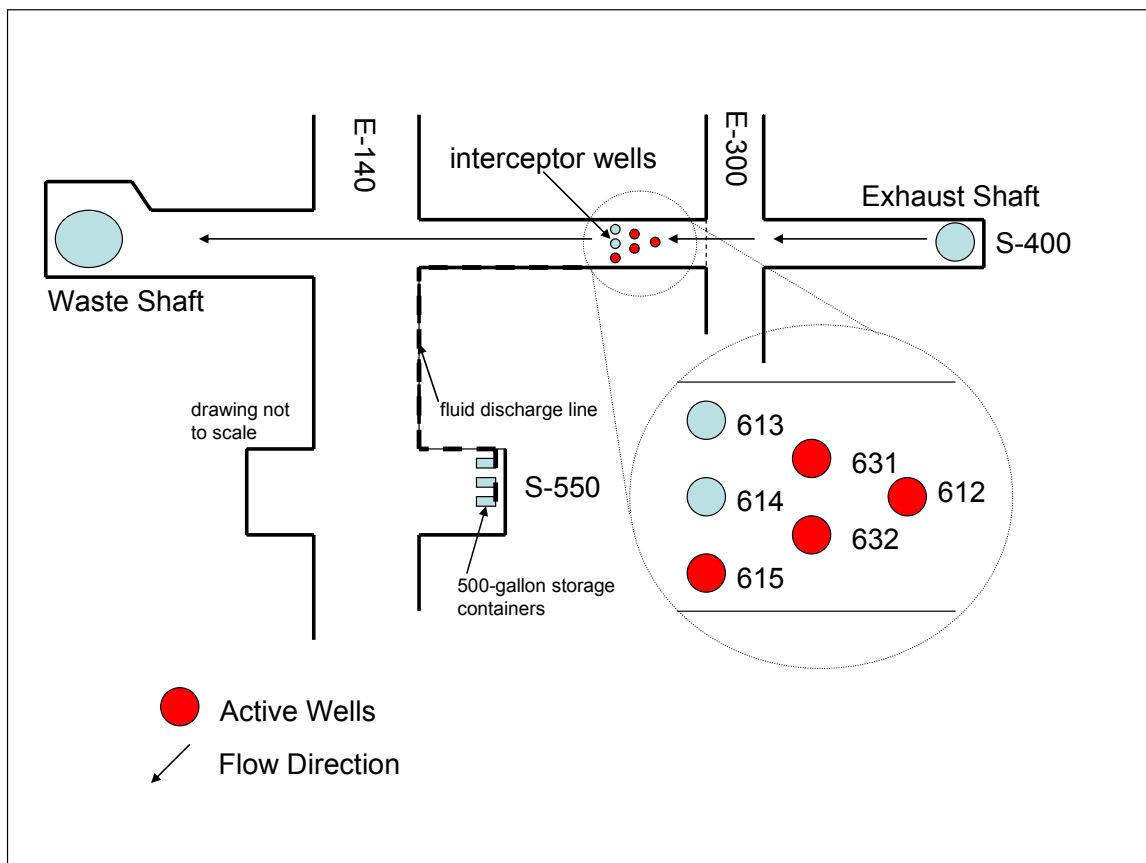

Figure 3-10 – Location of Interception Wells and Storage Containers

Table 3-1 and Figure 3-11 present the volume of fluid removed from the catch basin from July 1997 through June 2006, and by the interception well system from July 2006 through June 2011. The largest reported volumes are typically associated with periods of reduced ventilation and increased humidity. For a discussion of the factors affecting the quantity of fluid produced in the Exhaust Shaft, refer to DOE/WIPP 00-2000, *Brine Generation Study*.

The shaft walls were examined for salt buildup, cracks, moisture, and encrustations, with particular attention paid to power cables, instrument cables, air lines and water-lines, and the three water rings at the base of the Magenta and Culebra members of the Rustler Formation and the bottom of the shaft key. The condition of the shaft wall varies depending on airflow, humidity, temperature, and underground mining activities. During this reporting period, significant mining activity continued in Panel 7. The principal areas in the shaft with significant salt buildup were the three water rings at the Magenta, the Culebra, and the key, and along upper portions of the shaft generally associated with power cables, support brackets, instrument cables, and the air lines and water-lines.

Though the Magenta and Culebra water rings are encrusted with salt buildup, no water appears to originate from the liner or water rings. Most of the seepage was observed along the east face of the shaft wall near the instrumentation cables and the air lines and water-lines in the upper section of the shaft. Though the presence of water is an inconvenience requiring periodic disposal, at this time it does not appear to have created any hazard or affected the structural integrity of the shaft. However, brine increases the probability of corrosion and deterioration of utility hangers and brackets. There are no visible signs of dissolution of the salt below the key.

The video inspections also focused on the installed utilities and support brackets. These include a 13.8 kVA power cable that is no longer active and the grounding cable on the west wall of the shaft, the instrumentation cables on the northeast wall of the shaft, and the 4 in. air-line and the 2-in. water-line on the east wall of the shaft.

Sporadic salt buildup continues on all cables. The long-term implication of salt buildup is increased loading on cables and cable hangers, accompanied by intermittent falls of debris. The 4-in. compressed air-line and the 2-in. water-line extend from the surface to the bottom of the shaft. At present, neither line is being used. The integrity of the brackets holding the air-line and water-line was difficult to assess because of salt buildup; however, there was no indication that the brackets were broken. Instrumentation cable breaks were observed in the shaft; however, most of these breaks affected abandoned cables, with negligible impact on shaft monitoring and operations.

Geotechnical Analysis Report for July 2010 – June 2011
DOE/WIPP-12-3484, Vol. 1

Table 3-1 – Water Removed from the Exhaust Shaft Catch Basin and the Interception Well System

July 1997 – June 1998		July 1998 – June 1999		July 1999 – June 2000		July 2000 – June 2001		July 2001 – June 2002		July 2002 – June 2003	
Date	Gallons	Date	Gallons	Date	Gallons	Date	Gallons	Date	Gallons	Date	Gallons
7/18/1997	275	7/1/1998	770	7/19/1999	110	7/3/2000	220	7/31/2001	165	7/2/2002	165
7/28/1997	660	7/7/1998	330	12/13/1999	165	7/15/2000	110	8/21/2001	1,595	7/8/2002	440
8/1/1997	550	7/14/1998	220	2/21/2000	110	9/18/2000	330	9/13/2001	330	7/9/2002	495
8/4/1997	715	7/16/1998	275	5/16/2000	715	10/24/2000	110	10/15/2001	770	7/10/2002	660
8/8/1997	770	7/23/1998	165	6/7/2000	165	3/7/2001	110	10/30/2001	220	7/30/2002	220
8/11/1997	660	7/24/1998	220	6/12/2000	275	3/21/2001	165	4/29/2002	275	9/17/2002	165
8/15/1997	475	7/27/1998	825	6/19/2000	440	4/10/2001	220	6/11/2002	550	9/24/2002	330 Sludge
8/18/1997	330	7/28/1998	330	6/22/2000	330	4/17/2001	220	6/22/2002	330	3/25/2003	220 Sludge
8/22/1997	330	8/3/1998	495	6/30/2000	165	4/24/2001	110	TOTAL	4,235	5/27/2003	55
8/25/1997	1045	8/10/1998	1265	TOTAL	2,475	5/22/2001	110			6/3/2003	220
8/25/1997	110 Sludge	8/21/1998	330			5/22/2001	440 Sludge			6/25/2003	330
9/2/1997	220	8/24/1998	990			6/12/2001	1100			TOTAL	3,300
9/15/1997	605	8/27/1998	1155			6/13/2001	110				
9/22/1997	550	9/1/1998	330			6/13/2001	110				
10/13/1997	825	10/5/1998	385			TOTAL	3,465				
10/20/1997	220	10/26/1998	660								
11/3/1997	275	11/23/1998	110								
11/10/1997	385	2/1/1999	385								
11/17/1997	385	2/10/1999	110								
11/24/1997	330	5/4/1999	330								
12/10/1997	440	5/11/1999	110								
12/12/1997	550	5/24/1999	605								
1/2/1998	220	5/26/1999	165								
1/12/1998	605	5/28/1999	165								
2/2/1998	660	6/1/1999	165								
2/16/1998	605	6/4/1999	165								
3/16/1998	605	6/10/1999	165								
5/4/1998	660	6/10/1999	165 Sludge								
5/11/1998	550	6/16/1999	165								

Geotechnical Analysis Report for July 2010 – June 2011
DOE/WIPP-12-3484, Vol. 1

Table 3-1 – Water Removed from the Exhaust Shaft Catch Basin and the Interception Well System (Continued)

July 1997 – June 1998		July 1998 – June 1999		July 1999 – June 2000		July 2000 – June 2001		July 2001 – June 2002		July 2002 – June 2003	
Date	Gallons	Date	Gallons	Date	Gallons	Date	Gallons	Date	Gallons	Date	Gallons
5/18/1998	495	6/21/1999	1,705								
5/20/1998	110	6/23/1999	275								
6/1/1998	330	6/30/1999	605								
6/10/1998	90	TOTAL	14,135								
6/15/1998	385										
6/22/1998	165										
TOTAL	16,185										
July 2003 - June 2004		July 2004 - June 2005		July 2005 - June 2006		July 2006 - June 2007		July 2007 - June 2008		July 2008 - June 2009	
Date	Gallons	Date	Gallons	Date	Date	Gallons	Gallons	Date	Gallons	Date	Gallons
7/8/2003	605	11/29/2004	660 sludge	8/1/2005	1,100	7/11/2006	250	7/11/2007	200	7/31/2008	225
7/9/2003	550	12/6/2004	275 sludge	8/15/2005	880	8/16/2006	420	7/20/2007	400	8/31/2008	50
7/17/2003	165	1/3/2005	440	10/10/2005	715	8/17/2006	400	7/29/2007	420	9/30/2008	115
8/12/2003	275	1/4/2005	220	3/16/2006	55	9/1/2006	420	7/29/2007	410	11/30/2008	65
10/14/2003	165	1/10/2005	385	5/30/2006	400	9/7/2006	420	8/4/2007	410	1/31/2009	65
10/20/2003	440	5/16/2005	660	TOTAL	3,150	9/18/2007	840	8/14/2007	1000	5/31/2009	927
10/21/2003	330	6/1/2005	660			11/10/2006	150	8/15/2007	820	6/30/2009	425
11/23/2003	220	6/6/2005	220			11/15/2006	400	9/5/2007	820		
11/23/2003	660 sludge	6/20/2005	440			1/30/2007	310	11/8/2007	150		
TOTAL	3,410	6/27/2005	220			5/11/2007	75	11/9/2007	110		
		TOTAL	4,180			6/20/2007	200	12/4/2007	150		
						TOTAL	3,885	6/11/2008	750		
								TOTAL	5,640	TOTAL	1,872

**Geotechnical Analysis Report for July 2010 – June 2011
DOE/WIPP-12-3484, Vol. 1**

Table 3-1 - Water Removed from the Exhaust Shaft Catch Basin and the Interception Well System (Continued)

July 2009 - June 2010		July 2010- June 2011		July 2011 - June 2012		July 2012 - June 2013		July 2013- June 2014		July 2014 - June 2015	
Date	Gallons	Date	Gallons								
7/2/2009	870	7/3/2010	950								
9/19/2009	180	7/7/2010	790								
1/26/2010	50	7/8/2010	875								
5/3/2010	450	7/16/10	475								
		7/18/2010	390								
		7/23/2010	475								
		3/3/2011	80								
		6/29/11	165								
TOTAL	1,550		4,200								

Geotechnical Analysis Report for July 2010 – June 2011
DOE/WIPP-12-3484, Vol. 1

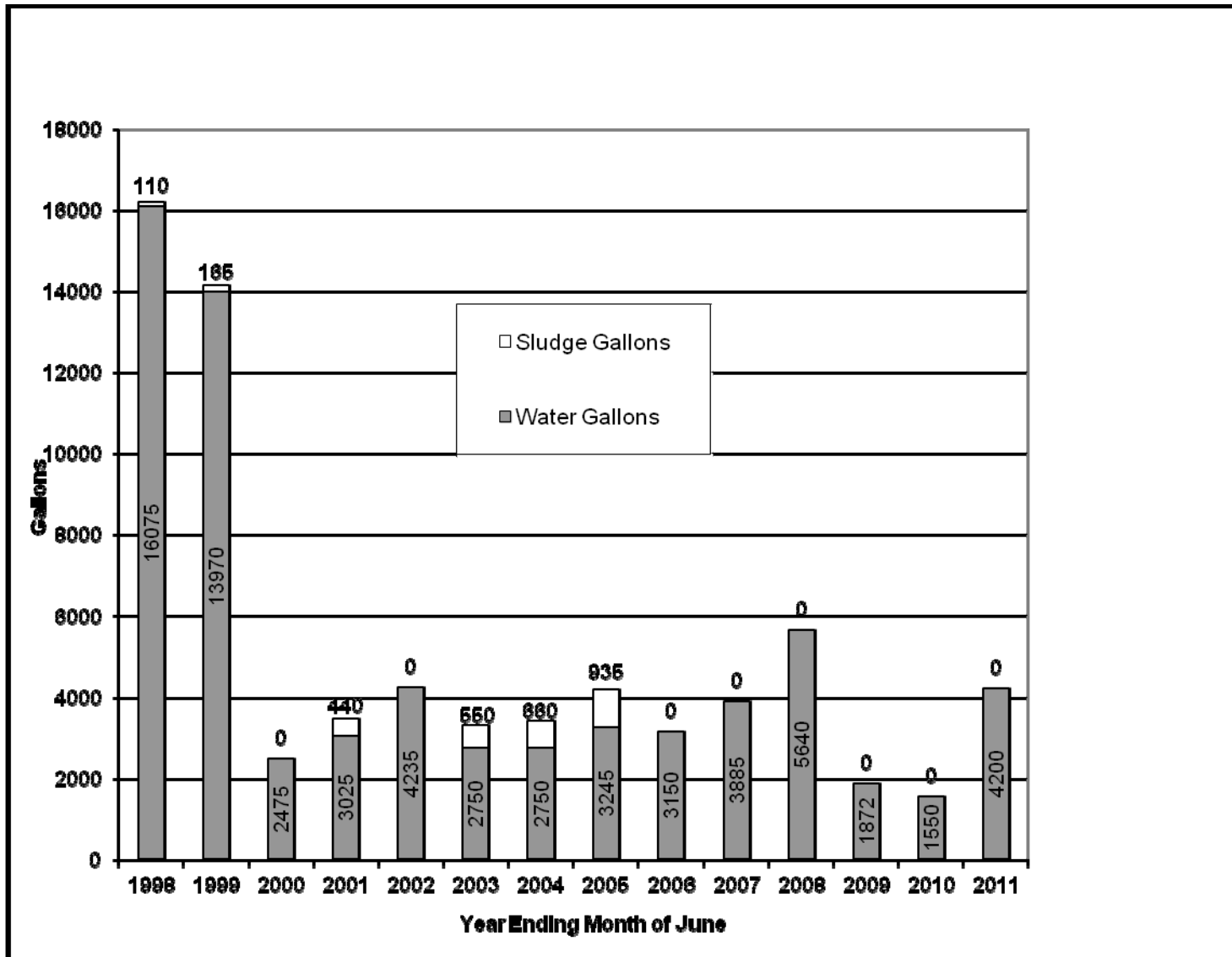

Figure 3-11 – Water Removed from the Exhaust Shaft Catch Basin and the Interception Well System

3.3.2 Instrumentation

The Exhaust Shaft was equipped with geomechanical instrumentation in two stages. Earth pressure cells were installed behind the liner key in November 1984. Piezometers and nine multi-position extensometers were installed during November and December 1985. Figure 3-12 and Figure 3-13 show the instrument locations.

Eight piezometers remain in working condition. The fluid pressure readings from the working piezometers at the end of the reporting period range from -3 psi (-21 kPa) at 544 ft (166 m) to 141 psi (972 kPa) at 721 ft (220 m). Maximum pressure readings from the working piezometers during this reporting period were consistent with maximum readings from the previous reporting period.

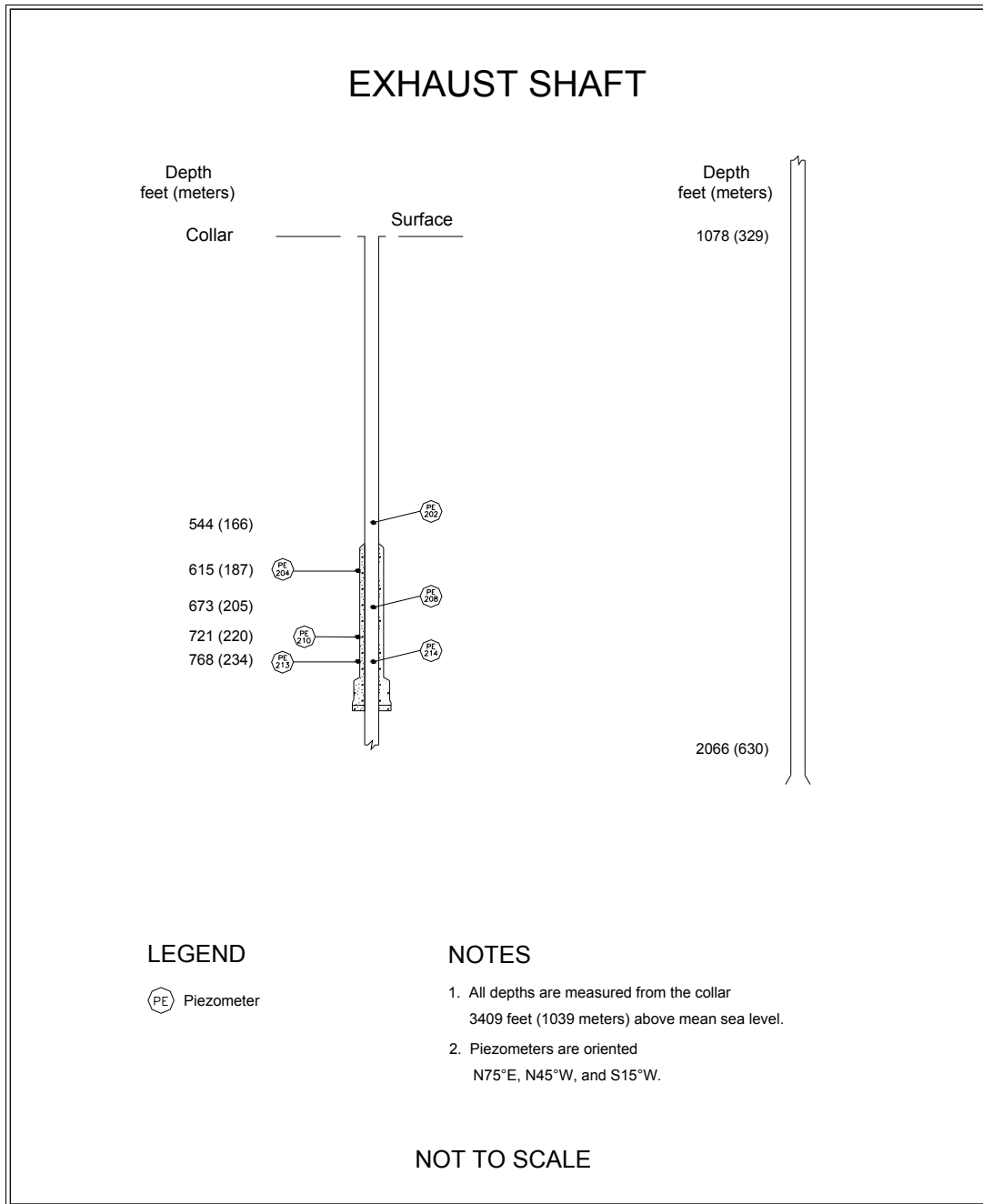

Figure 3-12 – Exhaust Shaft Instrumentation (Without Shaft Key)

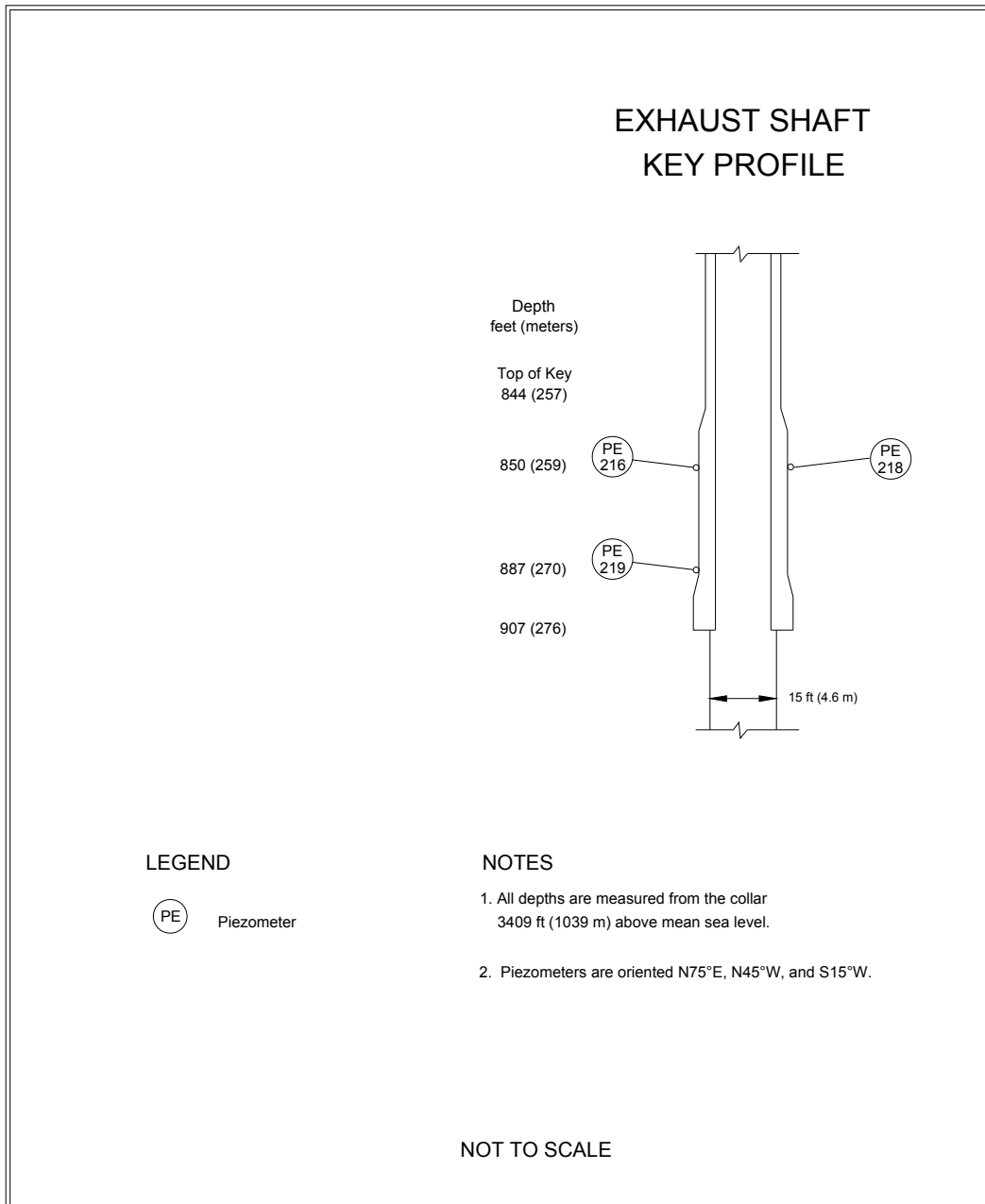

Figure 3-13 – Exhaust Shaft Key Instrumentation

3.4 Air Intake Shaft

The Air Intake Shaft was drilled from December 4, 1987, to August 31, 1988, to establish a primary route for surface air to enter the repository (see Figure 1-2). The stratigraphy was mapped from September 14, 1988, to November 14, 1989 (Holt and Powers, 1990). Figure 3-14 summarizes the shaft stratigraphy.

The Air Intake Shaft is lined with non-reinforced concrete from the surface to the bottom of the shaft key at 903 ft (275 m). The key is 81 ft (25 m) long with an inside diameter of 16 ft (5 m). The shaft diameter below the key is 20 ft (6 m), and the shaft below the key is unlined to the facility horizon at 2,150 ft (655 m). The shaft walls are bolted and meshed from just below the key all the way down to the shaft station. This shaft has no sump.

3.4.1 Shaft Performance

Weekly visual inspections were performed on the Air Intake Shaft during this reporting period, and the shaft was found to be in satisfactory condition. No ground control activities other than routine maintenance were required during this reporting period.

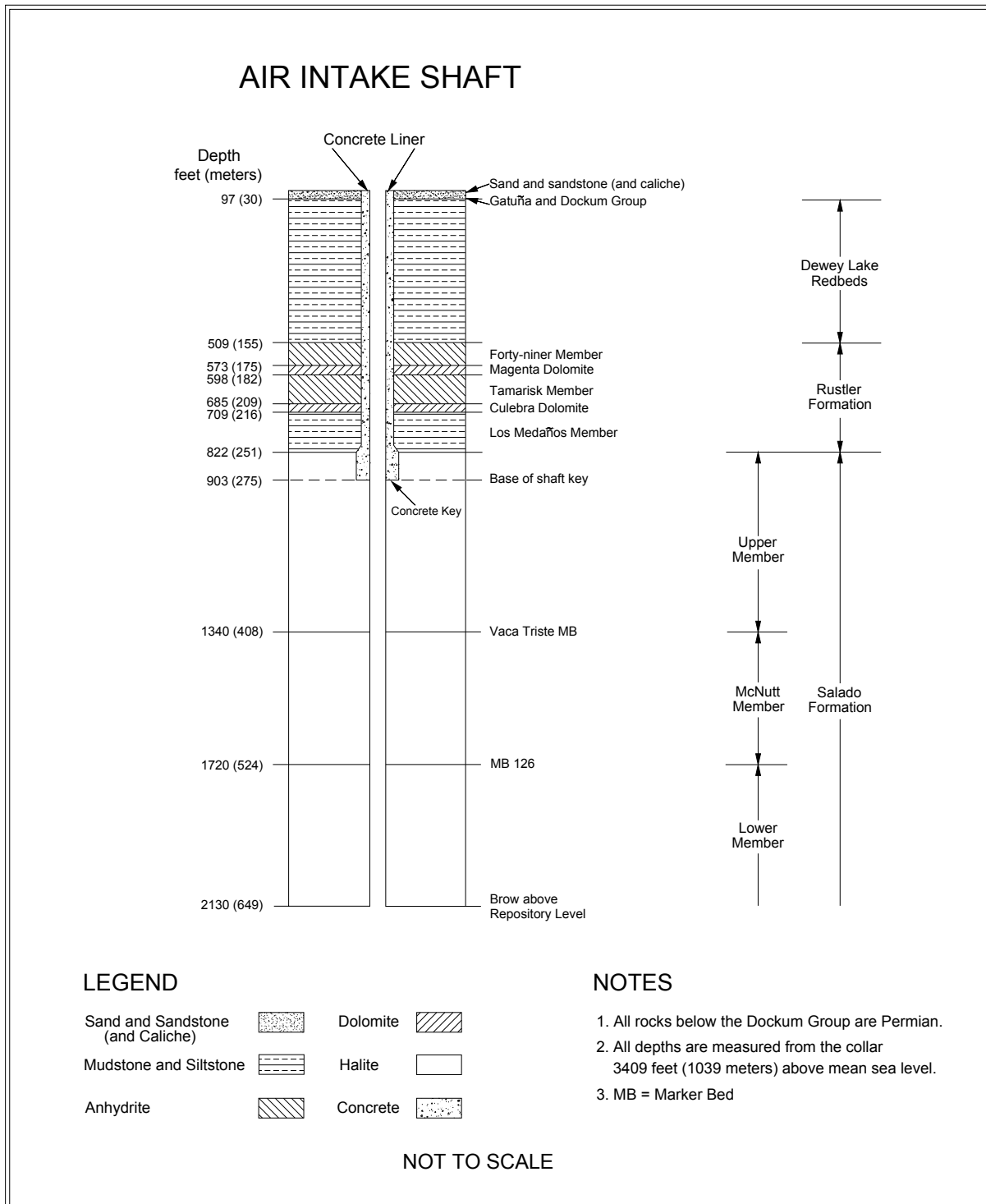

Figure 3-14 – Air Intake Shaft Stratigraphy

4.0 PERFORMANCE OF SHAFT STATIONS

This chapter describes the instrumentation and geomechanical performance of the shaft stations at the base of the Salt Shaft, the Waste Shaft, and the Air Intake Shaft. The Exhaust Shaft does not have an enlarged shaft station; therefore, it is not included in this chapter.

4.1 Salt Shaft Station

The Salt Shaft Station was excavated by drilling and blasting between May 2 and June 3, 1982. In 1987 the station was enlarged by removing the roof beam up to Anhydrite "b" between S-90 and N-20 using a mechanical scaler. In 1995, the remaining roof beam at the north end of the station was also removed up to Anhydrite "b." The station area south of the shaft is 90 ft (27.5 m) long and 32 to 38 ft (10 to 12 m) wide. The height of the station south of the shaft is 18 ft (5.5 m). The station dimensions north of the shaft are approximately 30 ft (9 m) long, 32 to 35 ft (10 to 11 m) wide, and 18 ft (5.5 m) high. The shaft extends approximately 140 ft (43 m) below the facility horizon to accommodate the skip loading equipment and a sump. Figure 4-1 shows a cross section of the station.

4.1.1 Modifications to Excavation and Ground Control Activities

No significant modifications were performed in the Salt Shaft Station during this reporting period. Ground control activities were limited to routine maintenance.

4.1.2 Instrumentation

Geomechanical instrumentation was installed in the Salt Shaft Station between June 1982 and February 1983, with subsequent re-installation of extensometers and convergence points as necessary. Figure 4-2 shows the instrument locations after the roof beam was taken down.

Five vertical convergence point arrays are currently monitored. Table 4-1 summarizes the vertical closure rates in the Salt Shaft Station from July 2010 through June 2011. Salt Shaft Station vertical closure rates indicate that the rates are slightly higher than during the previous reporting period.

Geotechnical Analysis Report for July 2010 – June 2011
DOE/WIPP-12-3484, Vol. 1

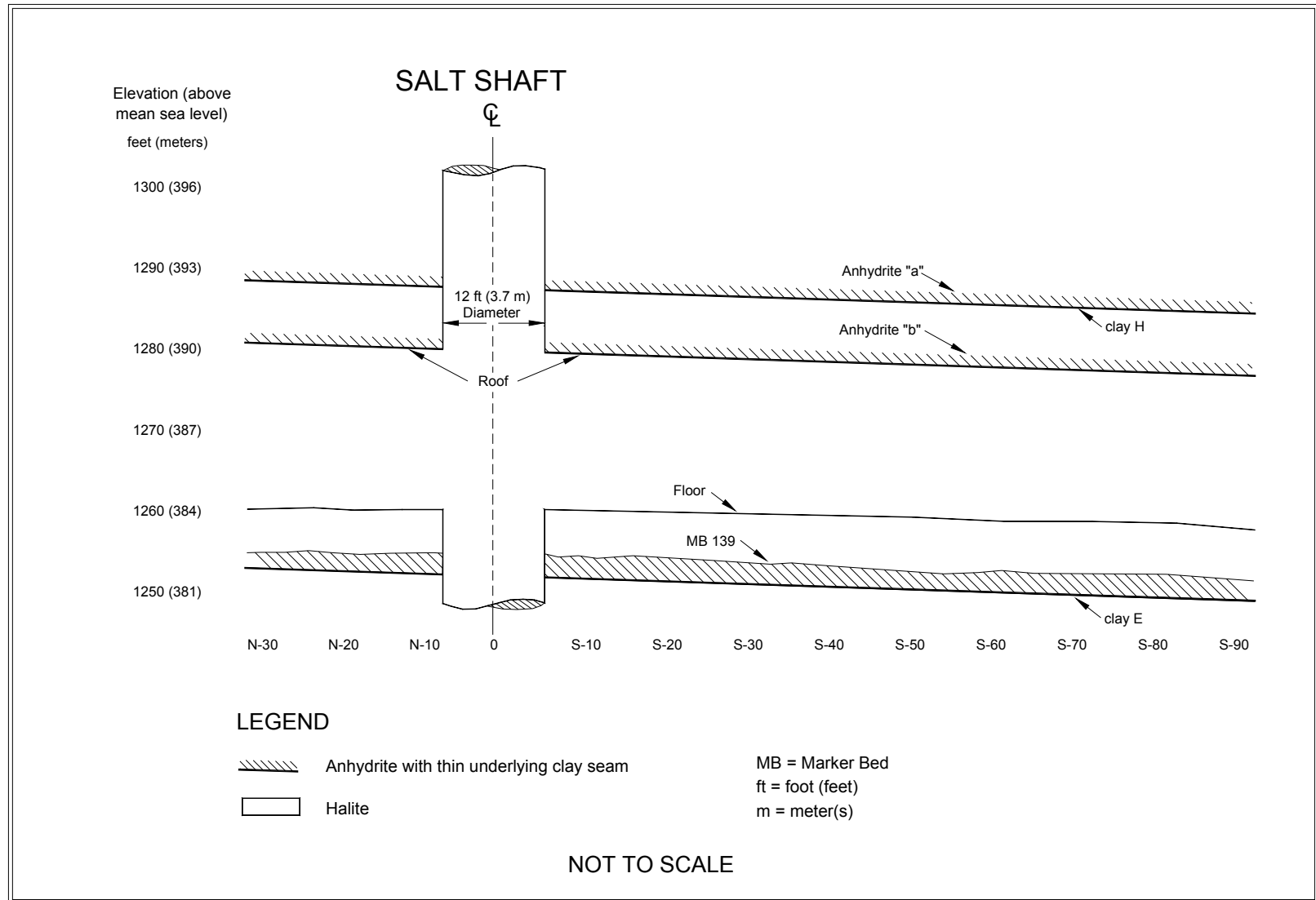

Figure 4-1 – Salt Shaft Station Stratigraphy

**Geotechnical Analysis Report for July 2010 – June 2011
DOE/WIPP-12-3484, Vol. 1**

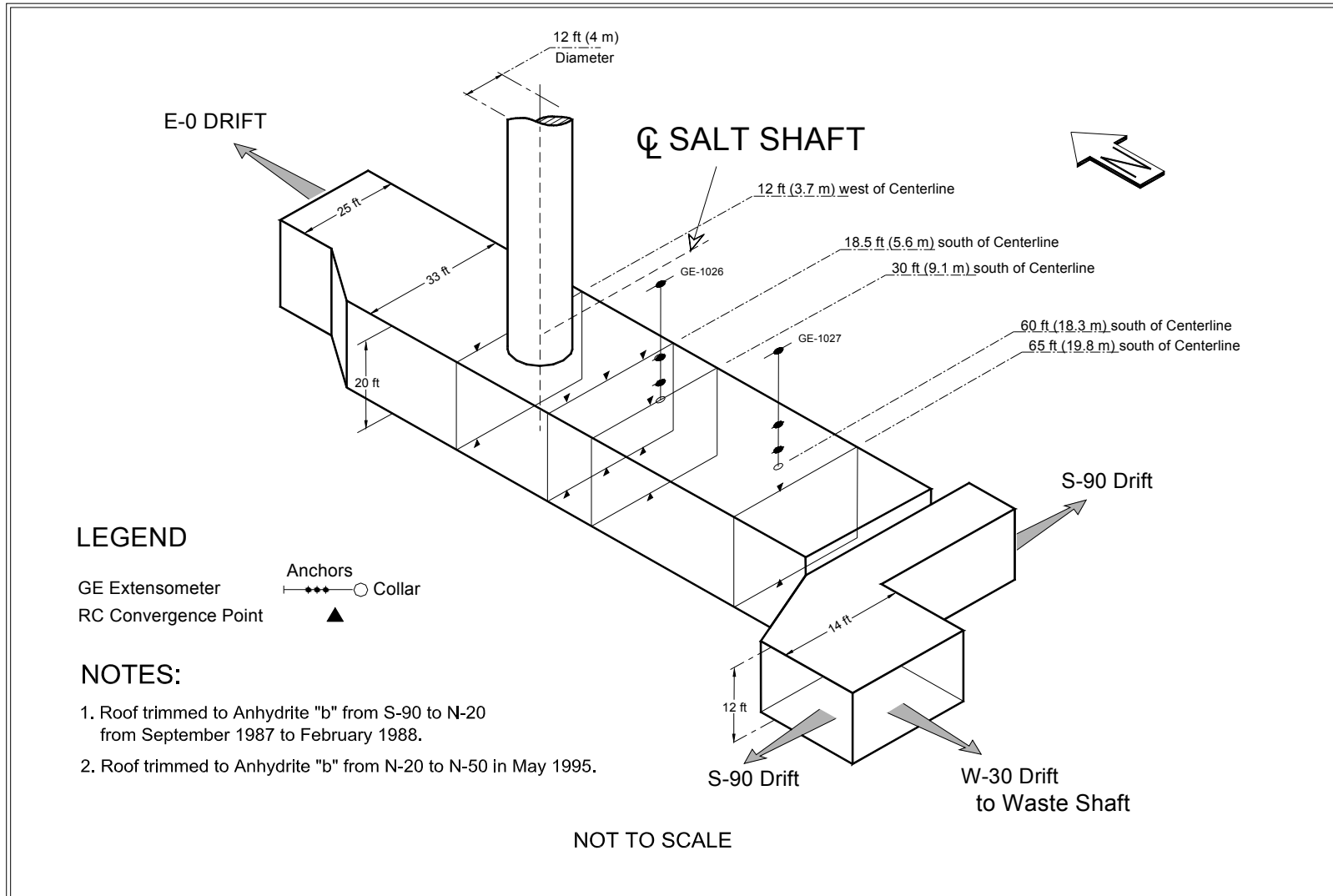

Figure 4-2 – Salt Shaft Station Instrumentation after Roof Beam Excavation

Table 4-1 – Vertical Closure Rates in the Salt Shaft Station

Location	Chord¹	Last Reading	Total Cumulative Displacement in (cm.)	Closure Rate 2010 to 2011 in/yr (cm/yr)	Closure Rate 2009 to 2010 in/yr (cm/yr)	Rate Change Percent
E-0, S-18	A-E	06/29/11	38.033 (96.60)	1.85 (4.70)	1.37 (3.48)	35%
E-0, S-18	B-D	06/29/11	39.407 (100.09)	2.01 (5.11)	1.52 (3.86)	32%
E-0, S-18	F-H	06/29/11	24.741 (62.84)	1.26 (3.20)	0.92 (2.34)	37%
E-0, S-30	A-C	06/29/11	52.805 (134.12)	1.88 (4.78)	1.40 (3.56)	34%
E-0, S-65	A-C	05/04/11	45.416 (115.36)	1.17 (2.97)	1.11 (2.82)	5%

¹ Chord is defined in Section 5.3

4.2 Waste Shaft Station

The Waste Shaft Station was initially excavated with a continuous miner as a ventilation connection to a 6-ft (2-m) diameter exhaust shaft in November 1982. In 1984, the station was enlarged to a height of 15 to 20 ft (4.5 to 6 m) and a width of 20 to 30 ft (6 to 9 m). The station is approximately 150 ft (46 m) long. In 1988, the station walls were trimmed, and concrete was placed on the floor. Since 1988, the Waste Shaft Station has undergone five major floor renovations. A 53-ft (16-m)-long section of the reinforced concrete was removed in February 1991, in 1995 an additional 30-ft (9-m) section was removed, and in 2000 floor maintenance included trimming of the floor and reinstallation of the rails supported by segmented concrete panels on a crushed rock backfill. The roof of the Waste Shaft station was mined up to Clay G in December 2008 to assure adequate operational clearance. 12-ft resin-anchored roof bolts and chain link were installed for ground support. Figure 4-3 shows a cross-section of the Waste Shaft Station.

4.2.1 Modifications to Excavation and Ground Control Activities

No modifications were made during this reporting period.

**Geotechnical Analysis Report for July 2010– June 2011
DOE/WIPP-12-3484, Vol. 1**

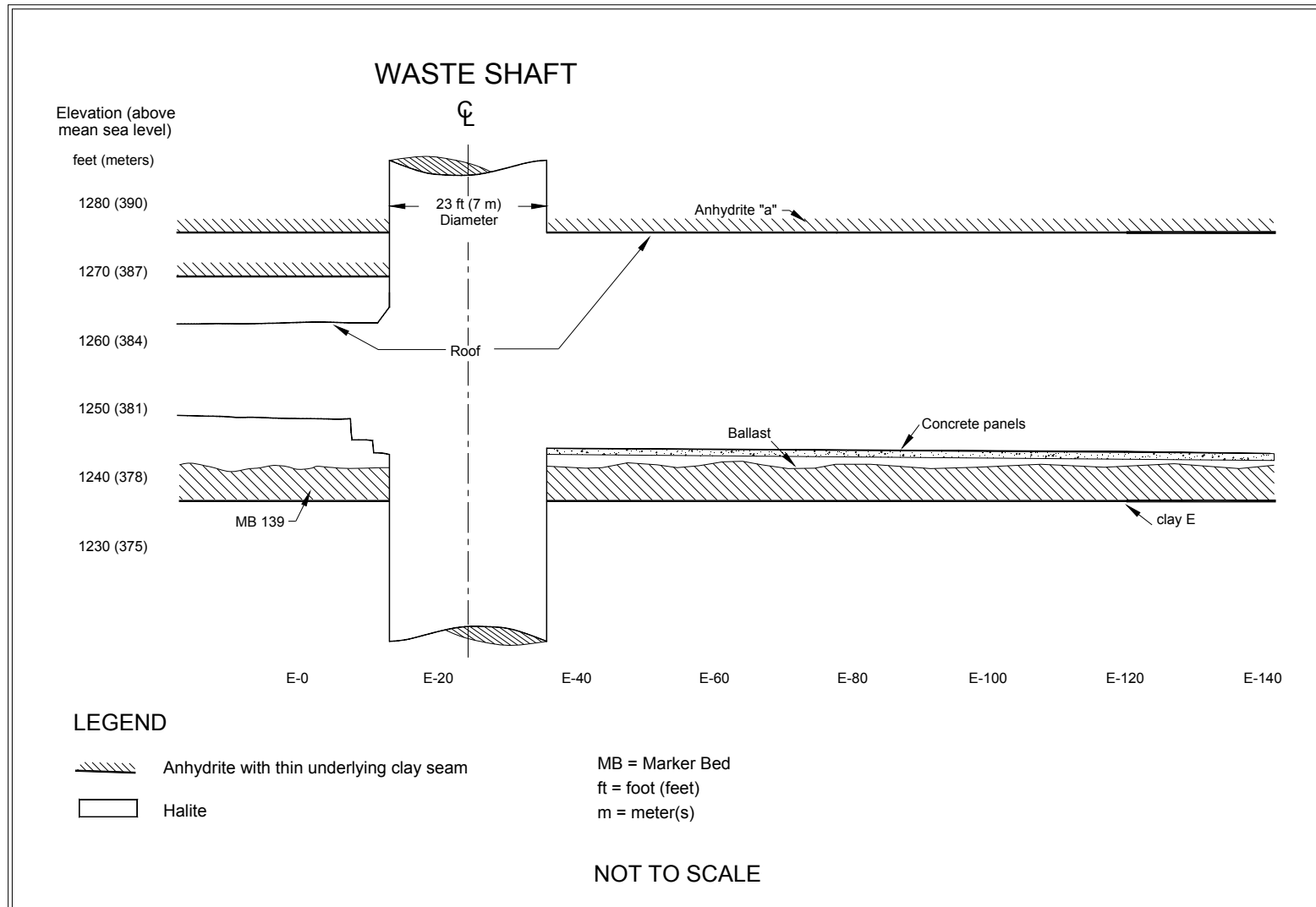

Figure 4-3 – Waste Shaft Station Stratigraphy

4.2.2 Instrumentation

Instruments were initially installed in the Waste Shaft Station between November 12 and December 2, 1982. Figure 4-4 illustrates the locations after enlargement. Two extensometers in the Waste Shaft Station are currently being monitored. In addition, horizontal convergence is being monitored at E-32 and E-85.

Table 4-2 summarizes the recent history of the roof extensometers in the Waste Shaft Station. Extensometer 51X-GE-00268 (W-30) is installed in a hole drilled into the roof of the station. Extensometer 51X-GE-00404-2 is located at approximately S400-E32.

Table 4-3 summarizes the annual closure rates calculated from convergence point data for this reporting period. The data indicate that the horizontal closure rates at both E-32 and E-85 have not changed significantly from the previous reporting period.

Table 4-2 – Summary of Roof Extensometers in Waste Shaft Station

Instrument	Location	Last Reading	Collar Displacement Relative to Deepest Anchor in (cm)	Displacement Rate 2010 to 2011 in/yr (cm/yr)	Displacement Rate 2009 to 2010 in/yr (cm/yr)	Rate Change Percent
51X-GE-00268	S-400, W-30	05/04/11	10.805 (27.44)	0.11 (0.28)	0.27 (0.69)	-59%
51X-GE-00404-2 ¹	WASTE STATION	06/27/11	0.283 (0.72)	0.27 (0.69)	0.29 (0.74)	-7%

¹ 2009-2010 rate from the previous installation (51X-GE-00404)

**Geotechnical Analysis Report for July 2010– June 2011
DOE/WIPP-12-3484, Vol. 1**

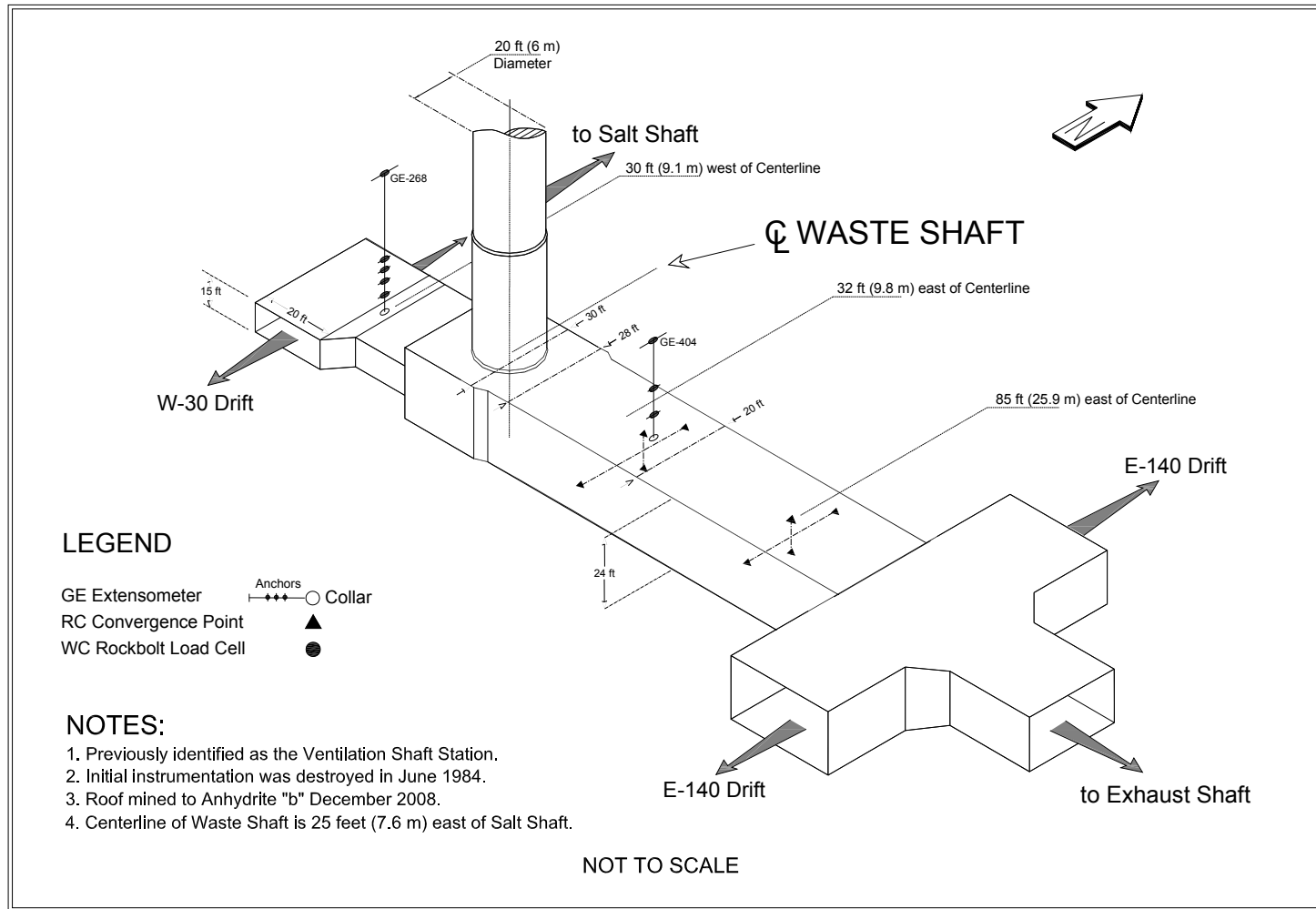

Figure 4-4 – Waste Shaft Station Instrumentation after Raising the Roof

Table 4-3 – Closure Rates in the Waste Shaft Station

Location	Chord ¹	Last Reading	Cumulative Displacement in (cm)	Closure Rate 2010 to 2011 in/yr (cm/yr)	Closure Rate 2009 to 2010 in/yr (cm/yr)	Rate change Percent
S-400, E-32	B-D	6/16/2011	2.918 (7.41)	1.26 (3.20)	1.17 (2.97)	8%
S-400, E-85	B-D	6/16/2011	2.963 (7.53)	1.32 (3.35)	1.16 (2.95)	14%

¹ Chord is defined in Section 5.3

4.3 Air Intake Shaft Station

The Air Intake Shaft Station was excavated in late 1987 and early 1988, using a continuous miner. The Air Intake Shaft is furnished with a work platform and a small cage that can be raised and lowered to perform routine ground maintenance. The principal purpose of that equipment is to provide emergency access.

4.3.1 Modifications to Excavation and Ground Control Activities

The AIS station was not significantly modified during this reporting period. Ground control activities were limited to routine maintenance.

4.3.2 Instrumentation

Radial convergence point and extensometer instrumentation data near the Air Intake Shaft Station are presented in Chapter 5.0 as part of the discussion on the performance of the access drifts. Twenty rock bolt load cells installed in the Air Intake Shaft Station area are monitored regularly.

5.0 PERFORMANCE OF ACCESS DRIFTS

This chapter describes the geomechanical performance of the underground access drifts. The Waste Disposal Area is discussed in Chapter 6.0. Four major north-south drifts in the WIPP underground are intersected by shorter east-west cross-drifts. Drift dimensions range from 13 ft (4 m) to 21 ft (6.4 m) high and from 14 ft (4.3 m) to 33 ft (9.2 m) wide.

5.1 Modifications to Excavation and Ground Control Activities

Trimming, scaling, and floor milling activities were performed as necessary in many areas. Table 5-1 summarizes these activities. It also summarizes ground control activities (e.g., rock bolting and installing wire mesh) in various locations in the access drifts.

5.2 Instrumentation

This section discusses instrumentation details and locations for each instrumentation type.

5.2.1 Extensometers

Twenty-eight extensometers are currently being monitored in the access drifts.

5.2.2 Convergence Points

Convergence points installed during this reporting period were limited to the replacement of arrays in previously mined areas and the installation of new monitoring arrays in newly mined areas. Replacement convergence points were installed in 84 locations throughout the WIPP underground access drifts. Horizontal and vertical convergence point arrays were installed at various locations. Most of these installations were located in E-140 and W-30, where floor trimming activities removed the existing points. Convergence points within the access drifts are read manually at least every two months, with more frequent monitoring in some areas. Table 5-2 lists the replacement convergence points that were installed during this reporting period.

Geotechnical Analysis Report for July 2010 – June 2011
DOE/WIPP-12-3484, Vol. 1

**Table 5-1 – Summary of Modifications and Ground Control Activities in the
 Access Drifts July 1, 2010 through June 30, 2011**

Location	Work Activity
E300 N250 to S90 (Maintenance Shop)	Installed bolts and mesh
E300 overcasts at S2520 and S2750	Replaced broken 12 ft resin anchored bolts and installed bolts and mesh on exposed salt
E140, S400 to S3650 (Waste Transport Route)	Replaced broken 12 ft resin anchored bolts
E140, S380, S400, S700	Installed 12 ft resin anchored bolts and mesh on brows
E140, S400 to S700	Installed 12 ft resin anchored bolt pattern
E140, S400 to S700	Installed bolts and mesh on ribs
E140, S875 to S920	Spot bolted on ribline
E140, N460 to N780	Installed 12 ft resin anchored bolts
E140, N780 and N1100	Installed 12 ft resin anchored bolts
E140, N1120	Installed 12 ft and 18 ft pull test bolts
E0, N780 to N1100	Installed 12 ft resin anchored bolts
E0, N1120	Installed 12 ft and 18 ft pull test bolts
W30, S700 to S3080	Installed bolts and mesh on ribs
W30, S3080 to S3650	Installed 12 ft resin anchored bolts
W170, N100	Spot bolted the Fuel Bay
W170, S2750 to S3080	Replaced broken 12 ft resin anchored bolts
W170, S1600 to S3650	Installed bolts and mesh on ribs
W170, S1950 to S3650	Installed 12 ft resin anchored bolts
N300, E0 to AIS	Replaced broken 12 ft resin anchored bolts
S700, E140 to E300	Spot bolted
S1950, W30 to E140	Installed 12 ft resin anchored bolt pattern and installed bolts and mesh on ribs
S2750, E140 to W170	Installed 12 ft resin anchored bolts
S2750, E140 to W170	Replaced broken 12 ft resin anchored bolts
S3080, W30 to W170	Replaced broken bolts and plates
S3080, W30 to E140	Installed 12 ft resin anchored bolt pattern
S3080, E300 to Panel 3 Closure	Installed 12 ft resin anchored bolts and installed bolts and mesh
S3310, W30 to W170	Installed 12 ft resin anchored bolts

Geotechnical Analysis Report for July 2010 – June 2011
DOE/WIPP-12-3484, Vol. 1

Table 5-2 – New and Replace Convergence Points Installed in the Access Drifts
July 1, 2010 through June 30, 2011

Location	New/Replaced	Field Tag ¹	Chord ²	Date Installed
E0-N225	R	E0-N0225-2	B-D	07/27/10
E0-N300	R	E0-N300-6	A-C	01/11/11
E140-S460	R	E140-S460-6	A-C	02/24/11
E140-S550	R	E140-S550-6	A-C	02/24/11
E140-S700	R	E140-S700-8	A-D	02/24/11
E140-S1225	R	E140-S1225-3	H-F	08/10/10
E140-S1378	R	E140-S1378-3	A-E	07/28/10
E140-S1378	R	E140-S1378-3	B-D	07/28/10
E140-S1378	R	E140-S1378-3	H-F	08/03/10
E140-S1450/1456	R	E140-S1450-5	A-G	07/28/10
E140-S1450/1456	R	E140-S1450-3	L-H	07/28/10
E140-S1450/1456	R	E140-S1450-3	B-F	07/28/10
E140-S1450/1456	R	E140-S1450-3	I-E	10/07/10
E140-S1534	R	E140-S1534-4	B-D	08/03/10
E140-S1534	R	E140-S1534-3	A-E	08/03/10
E140-S1534	R	E140-S1534-3	H-F	08/03/10
E140-S1600	R	E140-S1600-6	A-C	08/03/10
E140-S1687	R	E140-S1687-3	B-D	08/03/10
E140-S1687	R	E140-S1687-3	A-E	08/03/10
E140-S1687	R	E140-S1687-3	H-F	08/03/10
E140-S1775	R	E140-S1775-3	A-G	08/16/10
E140-S1775	R	E140-S1775-4	B-F	08/16/10
E140-S1775	R	E140-S1775-3	L-H	08/16/10
E140-S1862	R	E140-S1862-3	A-E	08/16/10
E140-S1862	R	E140-S1862-3	B-D	08/16/10
E140-S1862	R	E140-S1862-3	H-F	08/16/10
E140-S1950	R	E140-S1950-6	A-C	08/17/10
E140-S2007	R	E140-S2007-6	A-C	08/17/10
E140-S2065	R	E140-S2065-5	A-C	08/17/10
E140-S2122	R	E140-S2122-4	A-C	08/17/10
E140-S2275	R	E140-S2275-4	A-C	08/17/10
E140-S2350	R	E140-S2350-5	A-C	08/17/10
E140-S2425	R	E140-S2425-4	A-C	08/17/10
E140-S2520	R	E140-S2520-3	A-C	08/17/10
E140-S2750	R	E140-S2750-3	A-C	09/28/10
E300-S700	R	E300-S700-2	A-C	03/02/11
E300-S850	R	E300-S850-2	B-D	03/01/11
E300-S850	R	E300-S850-2	A-E	03/01/11
E300-S850	R	E300-S850-2	H-F	03/01/11
E300-S1000	R	E300-S1000-2	A-C	03/02/11
E300-S1150	R	E300-S1150-4	A-E	03/02/11
E300-S1150	R	E300-S1150-4	H-F	03/02/11
E300-S1150	R	E300-S1150-4	B-D	03/02/11
E300-S1300	R	E300-S1300-2	A-C	03/02/11
E300-S1450	R	E300-S1450-2	A-C	03/02/11
E300-S1687	R	E300-S1687-2	A-C	03/07/11
E300-S1775	R	E300-S1775-2	A-C	03/07/11
E300-S1862	R	E300-S1862-2	A-C	03/07/11
E300-S2065	R	E300-S2065-2	A-C	03/07/11

Geotechnical Analysis Report for July 2010 – June 2011
DOE/WIPP-12-3484, Vol. 1

Table 5-2 – New and Replace Convergence Points Installed in the Access Drifts
July 1, 2010 through June 30, 2011

Location	New/Replaced	Field Tag ¹	Chord ²	Date Installed
E300-S2275	R	E300-S2275-2	A-C	03/07/11
E300-S2350	R	E300-S2350-2	A-C	03/07/11
E300-S2425	R	E300-S2425-2	A-C	03/07/11
E300-S2634	R	E300-S2634-2	A-C	03/07/11
E300-S2833	R	E300-S2833-2	A-C	03/07/11
E300-S2916	R	E300-S2916-4	A-C	03/07/11
E300-S2998	R	E300-S2998-4	A-C	03/07/11
N780-E220	R	N780-E220-2	A-C	02/24/11
S1950-E311	R	S1950-E311-7	A-C	08/26/10
S2180-W100	R	S2180-W100-3	A-C	10/26/10
S2520-W100	R	S2520-W100-2	B-D	10/26/10
S2750-E55	R	S2750-E55-2	A-C	07/27/10
S2750-W93	R	S2750-W93-2	A-C	07/27/10
S3080-E55	R	S3080-E0055-2	A-C	03/07/11
W170-S2998	R	W170-S2998-2	B-D	08/26/10
W30-S1000	R	W30-S1000-5	A-C	10/20/10
W30-S2067	R	W30-S2067-2	A-C	07/12/10
W30-S2067	R	W30-S2067-3	B-D	07/12/10
W30-S2180	R	W30-S2180-3	A-C	07/12/10
W30-S2275	R	W30-S2275-3	A-C	07/15/10
W30-S2275	R	W30-S2275-2	B-D	07/15/10
W30-S2350	R	W30-S2350-2	B-D	07/12/10
W30-S2350	R	W30-S2350-3	A-C	07/12/10
W30-S2425	R	W30-S2425-3	A-C	07/19/10
W30-S2425	R	W30-S2425-2	B-D	07/19/10
W30-S2520	R	W30-S2520-3	A-C	07/21/10
W30-S2685	R	W30-S2685-3	A-C	07/21/10
W30-S2685	R	W30-S2685-3	B-D	07/21/10
W30-S2750	R	W30-S2750-2	A-C	07/21/10
W30-S2833	R	W30-S2833-2	A-C	07/21/10
W30-S2833	R	W30-S2833-2	B-D	07/21/10
W30-S2833	R	W30-S2833-3	A-C	12/03/10
W30-S2916	R	W30-S2916-2	B-D	07/21/10
W30-S2998	R	W30-S2998-2	B-D	07/27/10
W30-S700	R	W30-S700-5	A-C	07/27/10

N = New installation.

R = Replacement installation (i.e., instrument replaces older instrument that has failed or has been mined out).

¹ This column is a combination of the convergence point location followed by a "-X," where X represents the reinstallation number, when applicable.

² A unique letter is assigned to each convergence array element around a particular opening. Chord refers to a particular array pair. The various array lettering schemes are shown in Figure 5-1.

5.3 Analysis of Convergence Point and Extensometer Data

Convergence point data are obtained by measuring the change in distance between fixed points anchored into the rock across an opening, either from rib to rib or from roof to floor. The measurement end-points constitute a "chord." Figure 5-1 shows typical convergence point array configurations along with typical chord designations.

Extensometer data are obtained by measuring the displacement from the reference head anchor (collar) to each fixed anchor of the extensometer. These measurements are made, at a minimum, every two months throughout the WIPP underground, except when convergence points are not accessible. Convergence rates and extensometer displacement rates indicate how an excavation is performing; rates that decrease or are relatively constant typify stable excavations, whereas increasing rates may indicate some type of developing instability or may be the response to nearby mining.

Where possible, annual closure rates were calculated from convergence point array data gathered in the access drifts. A complete tabulation of these convergence point data and calculated closure rates is presented in the supporting data document for this report. Locations with increases in annual vertical closure rates of greater than 10 percent are shown in Table 5-3.

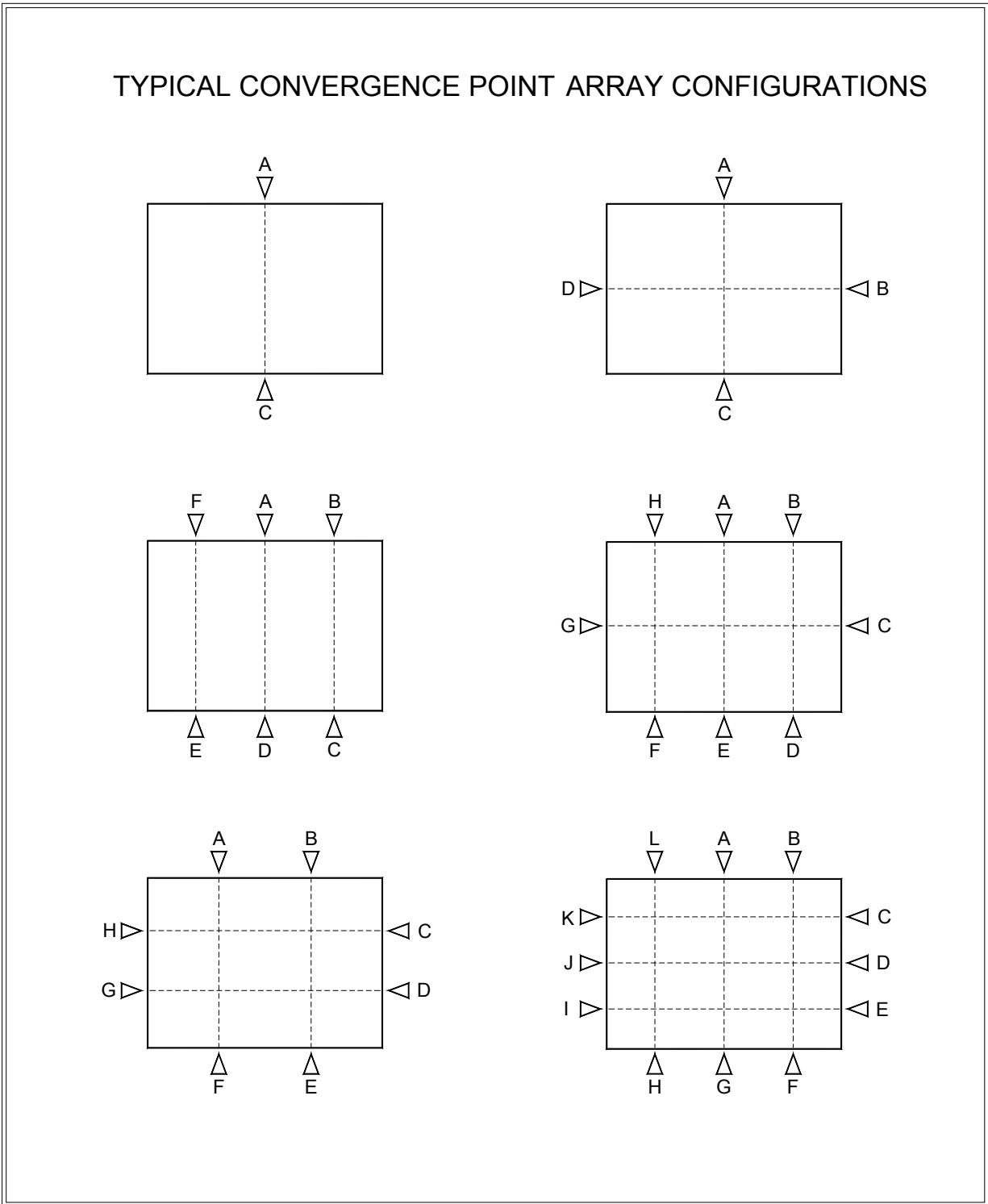

Figure 5-1 – Typical Convergence Point Array Configurations Showing Anchor Designations

Extensometer displacement rates and convergence rates are routinely plotted against time, and comparisons are made through time to identify any acceleration. Annual convergence rates are calculated by determining the difference between the first and last readings of the reporting period and dividing the difference by the time between the two readings (in years) (see Section 1.4.3). Instruments that indicate acceleration are analyzed to determine the significance of the acceleration. Factors considered during the analysis include magnitude of the respective rates, percentage increase, convergence history, and any recent excavation in the vicinity.

Twenty-eight extensometers continue to be monitored at various locations in the access drifts. Where displacement data were available, annual displacement rates were calculated for each active installation and compared to the annual displacement rates from the previous reporting period. Approximately 50 percent of the instruments are installed in the E 140 drift to monitor the waste transport route. Many of the E-140 extensometers indicate movement in the roof beam that may be attributed to shallow fracturing and the effects of anhydrite stringer separations in the roof. Lateral deformation in the roof beam may influence the extensometer readings, causing an increase in the measured displacement. Although the extensometer data indicate continued deformation and breakup of the lower beam, the roof bolt anchorage zone remains competent.

Closure rates are variable from year to year; however, locations that exhibit rate increases by more than ten percent are assessed in detail. Further analysis of the convergence rate accelerations has shown many of them to be minor and generally related to roof beam fracturing. Other areas had closure rate increases that can be directly attributed to drift widening and floor trims.

The closure rates observed in E-140 from S-1025 to S-2833 are in an area where the roof beam has been mined to Clay G. The rate of increase in this area may be attributed to roof beam separations formed along shallow anhydrite stringers in the roof. These separations result in the formation of thin roof beams that can easily be deformed toward the opening. Tensile fractures generally develop on the roof surface in areas of maximum deformation.

The rate increases observed in other areas may be attributable to various causes. Rate increases in W-30 and W-170 between S-2750 and S-3080 may be attributed to gradual deterioration of the roof beam along anhydrite stringers. Increases in E300 from S700 to S3080 are the result of floor mining completed during the holiday maintenance outage from December 2010 to January 2011.

Geotechnical Analysis Report for July 2010 – June 2011
DOE/WIPP-12-3484, Vol. 1

**Table 5-3 – Greater than 10 Percent Increases in Annual Vertical Convergence
From July 1, 2010 to June 30, 2011**

Location	Chord	Last Reading Date	Cumulative Displacement Inches (cm)	Closure Rate 2010 to 2011 in/yr (cm/yr)	Closure Rate 2009 to 2010 in/yr (cm/yr)	Rate Change Percent
E0-N1110	A-C	06/29/11	45.9 (116.7)	1.8 (4.6)	1.3 (3.3)	38%
E0-N1266	A-C	06/29/11	56.1 (142.4)	2.2 (5.6)	1.9 (4.8)	16%
E0-N225	A-C	06/29/11	17.7 (44.9)	2.0 (5.1)	1.6 (4.1)	25%
E0-N460	A-C	06/29/11	40.7 (103.4)	2.4 (6.1)	1.5 (3.8)	60%
E0-N562	A-C	05/04/11	14.8 (37.6)	2.0 (5.1)	1.8 (4.6)	11%
E0-N80	A-C	06/29/11	17.8 (45.2)	2.0 (5.1)	1.7 (4.3)	18%
E0-N80	A-C	06/29/11	34.8 (88.3)	2.0 (5.1)	1.7 (4.3)	18%
E0-N780	A-C	06/29/11	37.2 (94.4)	2.3 (5.8)	1.7 (4.3)	35%
E0-N940	A-C	06/29/11	64.8 (164.7)	3.2 (8.1)	2.3 (5.8)	39%
SH SHAFT-S18	A-E	06/29/11	38.0 (96.6)	1.9 (4.8)	1.4 (3.6)	36%
SH SHAFT-S30	A-C	06/29/11	52.8 (134.1)	1.9 (4.8)	1.4 (3.6)	36%
E140-N1100	A-C	05/11/11	10.3 (26.2)	1.7 (4.3)	1.3 (3.3)	31%
E140-N1420	A-C	05/12/11	27.8 (70.7)	1.7 (4.3)	1.4 (3.6)	21%
E140-N220	A-C	05/11/11	37.5 (95.3)	2.5 (6.4)	2.1 (5.3)	19%
E140-N355	A-C	05/11/11	17.9 (45.4)	2.2 (5.6)	1.9 (4.8)	16%
E140-N460	A-C	05/11/11	39.8 (101.2)	2.3 (5.8)	1.9 (4.8)	21%
E140-N5	A-C	05/12/11	42.5 (107.9)	2.3 (5.8)	2.1 (5.3)	10%
E140-N626	A-C	05/11/11	57.0 (144.7)	3.4 (8.6)	3.1 (7.9)	10%
E140-N780	A-C	05/11/11	55.3 (140.5)	2.9 (7.4)	2.2 (5.6)	32%
E140-S1300	A-C	06/15/11	35.2 (89.5)	1.7 (4.3)	1.4 (3.6)	21%
E140-S2634	A-C	06/15/11	47.8 (121.4)	6.5 (16.5)	5.4 (13.7)	20%
E140-S2833	A-C	06/15/11	31.5 (80.1)	5.0 (12.7)	4.0 (10.2)	25%
E140-S2998	A-C	06/15/11	35.9 (91.3)	3.9 (9.9)	3.4 (8.6)	15%
E140-S3080	A-C	06/15/11	23.4 (59.3)	3.3 (8.4)	2.6 (6.6)	27%
E140-S3295	A-C	06/14/11	13.4 (34.0)	2.5 (6.4)	2.1 (5.3)	19%
E140-S3325	A-C	06/14/11	13.1 (33.2)	2.4 (6.1)	2.0 (5.1)	20%
E140-S3480	A-C	06/14/11	23.4 (59.4)	4.0 (10.2)	3.6 (9.1)	11%
E140-S3565	A-C	06/14/11	18.0 (45.7)	2.9 (7.4)	2.6 (6.6)	12%
E140-S3650	A-C	06/08/11	11.4 (28.9)	2.1 (5.3)	1.7 (4.3)	24%
E140-S90	A-C	06/16/11	25.4 (64.5)	1.6 (4.1)	1.4 (3.6)	14%
E300-N170	A-E	06/22/11	30.3 (77.1)	1.8 (4.6)	1.5 (3.8)	20%
E300-N250	A-C	06/22/11	36.6 (93.0)	1.7 (4.3)	1.5 (3.8)	13%
E300-N45	A-E	06/22/11	30.4 (77.1)	1.5 (3.8)	1.3 (3.3)	15%
E300-S250	A-C	06/23/11	12.9 (32.9)	0.7 (1.8)	0.5 (1.3)	40%
E300-S3480	A-C	11/19/10	8.7 (22.0)	2.4 (6.1)	2.0 (5.1)	20%
E300-S45	A-E	06/22/11	24.6 (62.6)	1.4 (3.6)	1.1 (2.8)	27%
E300-S90	A-C	06/23/11	18.1 (46.0)	0.9 (2.3)	0.6 (1.5)	50%
N1420-E300	A-C	05/12/11	10.0 (25.3)	1.9 (4.8)	1.5 (3.8)	27%
N215-W500	A-C	05/10/11	28.8 (73.2)	1.3 (3.3)	1.2 (3.0)	8%
N215-W620	A-C	05/10/11	24.0 (60.9)	1.0 (2.5)	0.8 (2.0)	25%
N250-E220	A-E	06/22/11	35.8 (90.9)	2.6 (6.6)	2.3 (5.8)	13%
N780-E70	A-C	06/29/11	11.5 (29.3)	1.4 (3.6)	1.2 (3.0)	17%

Geotechnical Analysis Report for July 2010 – June 2011
DOE/WIPP-12-3484, Vol. 1

Table 5-3 – Greater than 10 Percent Increases in Annual Vertical Convergence
From July 1, 2010 to June 30, 2011

Location	Chord	Last Reading Date	Cumulative Displacement Inches (cm)	Closure Rate 2010 to 2011 in/yr (cm/yr)	Closure Rate 2009 to 2010 in/yr (cm/yr)	Rate Change Percent
S1000-E120	A-C	05/26/11	15.4 (39.2)	1.2 (3.0)	0.9 (2.3)	33%
S1000-E0160	A-C	05/26/11	3.0 (7.6)	1.0 (2.5)	0.7 (1.8)	43%
S1000-E58	A-C	05/26/11	23.3 (59.2)	1.4 (3.6)	1.1 (2.8)	27%
S1000-W98	A-C	05/26/11	32.2 (81.7)	2.0 (5.1)	1.8 (4.6)	11%
S1300-E120	A-C	05/26/11	13.9 (35.4)	1.1 (2.8)	0.8 (2.0)	38%
S1300-E160	A-C	05/26/11	21.4 (54.4)	2.0 (5.1)	1.5 (3.8)	33%
S1300-E24	A-C	05/26/11	21.4 (54.3)	1.4 (3.6)	1.2 (3.0)	17%
S1300-W100	A-C	05/26/11	34.7 (88.1)	2.3 (5.8)	1.9 (4.8)	21%
S1600-E110	A-C	05/26/11	14.8 (37.7)	1.1 (2.8)	0.9 (2.3)	22%
S1600-E170	A-C	05/26/11	16.2 (41.2)	1.2 (3.0)	0.9 (2.3)	33%
S1600-E170	A-C	05/26/11	16.2 (41.2)	1.2 (3.0)	0.9 (2.3)	33%
S1600-E357	A-C	05/25/11	23.0 (58.5)	1.1 (2.8)	0.8 (2.0)	38%
S1600-E382	A-C	05/25/11	22.8 (58.0)	1.0 (2.5)	0.7 (1.8)	43%
S1600-E453	A-C	05/25/11	4.4 (11.1)	0.7 (1.8)	0.6 (1.5)	17%
S1950-E113	A-C	05/26/11	12.0 (30.4)	1.3 (3.3)	0.7 (1.8)	86%
S1950-E281	A-C	05/25/11	20.6 (52.3)	1.3 (3.3)	1.0 (2.5)	30%
S1950-E284	A-C	05/25/11	20.9 (53.1)	1.4 (3.6)	1.0 (2.5)	40%
S1950-E332	A-C	05/25/11	37.2 (94.5)	1.7 (4.3)	1.5 (3.8)	13%
S1950-E357	A-C	05/25/11	43.4 (110.2)	2.3 (5.8)	2.0 (5.1)	15%
S1950-E382	A-C	05/25/11	46.4 (117.8)	2.7 (6.9)	2.3 (5.8)	17%
S1950-E432	A-C	05/25/11	48.9 (124.2)	3.4 (8.6)	1.9 (4.8)	79%
S2180-E220	A-C	06/07/11	14.2 (36.1)	1.6 (4.1)	1.3 (3.3)	23%
S2180-E220	A-C	06/07/11	14.2 (36.1)	1.6 (4.1)	1.3 (3.3)	23%
S2180-E410	A-C	06/07/11	13.9 (35.4)	1.5 (3.8)	1.2 (3.0)	25%
S2180-E410	A-C	06/07/11	13.9 (35.4)	1.5 (3.8)	1.2 (3.0)	25%
S2180-E55	A-C	06/07/11	15.2 (38.7)	2.1 (5.3)	1.8 (4.6)	17%
S2520-E220	A-C	06/07/11	18.7 (47.4)	1.8 (4.6)	1.5 (3.8)	20%
S2520-E410	A-C	06/07/11	28.9 (73.3)	3.5 (8.9)	3.0 (7.6)	17%
S2750-E220	A-C	06/07/11	21.4 (54.3)	3.1 (7.9)	2.0 (5.1)	55%
S2750-E410	A-C	06/07/11	21.1 (53.6)	4.5 (11.4)	3.0 (7.6)	50%
S3080-E220	A-C	06/06/11	17.2 (43.6)	2.8 (7.1)	2.2 (5.6)	27%
S3080-E55	A-C	01/04/11	17.2 (43.6)	2.8 (7.1)	2.1 (5.3)	33%
S3080-W100	A-C	06/07/11	21.2 (53.9)	4.5 (11.4)	3.4 (8.6)	32%
S3310-E220	A-C	06/08/11	22.4 (56.9)	5.8 (14.7)	3.2 (8.1)	81%
S3310-W285	A-C	06/07/11	7.9 (20.1)	2.2 (5.6)	1.7 (4.3)	29%
S3650-E55	A-C	06/07/11	7.5 (19.0)	1.8 (4.6)	1.6 (4.1)	13%
S3650-W100	A-C	06/07/11	11.2 (28.4)	2.6 (6.6)	1.8 (4.6)	44%
S700-E180	A-C	05/26/11	9.6 (24.4)	2.0 (5.1)	1.7 (4.3)	18%
S700-E205	A-C	05/26/11	26.9 (68.4)	2.0 (5.1)	1.7 (4.3)	18%
S700-W98	A-C	05/26/11	23.7 (60.1)	1.8 (4.6)	1.4 (3.6)	29%
S90-W590	A-C	06/02/11	13.2 (33.6)	0.7 (1.8)	0.6 (1.5)	17%
W170-N150	A-C	06/02/11	10.4 (26.4)	0.7 (1.8)	0.5 (1.3)	40%
W170-S1445	A-C	06/01/11	15.9 (40.3)	1.6 (4.1)	1.3 (3.3)	23%
W170-S1779	A-C	06/01/11	19.4 (49.2)	1.6 (4.1)	1.2 (3.0)	33%

**Table 5-3 – Greater than 10 Percent Increases in Annual Vertical Convergence
From July 1, 2010 to June 30, 2011**

Location	Chord	Last Reading Date	Cumulative Displacement Inches (cm)	Closure Rate 2010 to 2011 in/yr (cm/yr)	Closure Rate 2009 to 2010 in/yr (cm/yr)	Rate Change Percent
W170-S1950	A-C	06/01/11	16.5 (41.8)	1.4 (3.6)	1.0 (2.5)	40%
W170-S2060	A-C	06/01/11	17.7 (45.0)	1.5 (3.8)	1.1 (2.8)	36%
W170-S2180	A-C	06/28/11	22.6 (57.5)	2.7 (6.9)	1.3 (3.3)	108%
W170-S2275	A-C	06/27/11	13.6 (34.6)	2.0 (5.1)	1.2 (3.0)	67%
W170-S232	A-C	06/01/11	11.9 (30.2)	0.6 (1.5)	0.5 (1.3)	20%
W170-S2350	A-C	06/27/11	18.0 (45.8)	2.7 (6.9)	1.7 (4.3)	59%
W170-S2425	A-C	06/27/11	16.0 (40.5)	2.2 (5.6)	1.5 (3.8)	47%
W170-S2520	A-C	06/27/11	20.0 (50.9)	3.2 (8.1)	1.7 (4.3)	88%
W170-S2833	A-C	06/27/11	25.1 (63.7)	6.1 (15.5)	5.1 (13.0)	20%
W170-S2916	A-C	06/27/11	24.3 (61.7)	3.9 (9.9)	3.0 (7.6)	30%
W170-S3195	A-C	06/27/11	19.5 (49.6)	3.6 (9.1)	2.9 (7.4)	24%
W170-S3565	A-C	06/30/11	11.2 (28.6)	2.1 (5.3)	1.9 (4.8)	11%
W170-S3650	A-C	06/07/11	11.9 (30.3)	1.9 (4.8)	1.6 (4.1)	19%
W170-S400	A-C	06/01/11	14.5 (36.9)	0.8 (2.0)	0.6 (1.5)	33%
W30-S120	A-C	06/29/11	24.9 (63.1)	1.0 (2.5)	0.9 (2.3)	11%
W30-S250	A-C	06/29/11	32.1 (81.4)	1.4 (3.6)	1.1 (2.8)	27%
W30-S2916	A-C	06/27/11	32.5 (82.6)	7.2 (18.3)	5.2 (13.2)	38%
W30-S2998	A-C	06/27/11	17.3 (43.9)	3.9 (9.9)	2.7 (6.9)	44%
W30-S3195	A-C	06/27/11	16.6 (42.1)	2.4 (6.1)	2.0 (5.1)	20%
W30-S3310	A-C	06/27/11	15.4 (39.2)	1.8 (4.6)	1.6 (4.1)	13%
W30-S3480	A-C	06/30/11	12.8 (32.5)	2.7 (6.9)	2.3 (5.8)	17%
W30-S3565	A-C	06/30/11	9.2 (23.4)	1.6 (4.1)	1.4 (3.6)	14%
W30-S3650	A-C	06/07/11	10.0 (25.4)	2.0 (5.1)	1.6 (4.1)	25%
W30-S400	A-C	06/29/11	22.8 (58.0)	1.2 (3.0)	0.8 (2.0)	50%

5.4 Excavation Performance

Approximately 500 readings are collected and assessed regularly from convergence point arrays throughout the WIPP underground. Convergence rates continue to vary seasonally, typically increasing during the warmer and more humid summer months and decreasing during the cooler and drier winter months.

The performance of the access drift excavations during this reporting period was within acceptable criteria. "Acceptable criteria" means that a drift remains accessible, and the ground can be controlled by routine maintenance. Standard remedial ground control in some areas was required to maintain the performance of the excavations. The drifts remain stable and controlled. Most of the annualized rates remain steady, indicating stability. In some locations, where the rates are high, nearby mining activity or gradual deterioration of the roof beam along anhydrite stringers is most likely the cause. Where necessary, additional ground control measures have been or will be installed.

6.0 PERFORMANCE OF WASTE DISPOSAL AREA

The Waste Disposal Area as of June 30, 2011, consisted of Panels 1, 2, 3, 4, 5, and 6. Panels 1, 2, 3, and 4 were closed during previous reporting periods. Waste disposal in Panels 5 and 6 was ongoing. Panel 7 mining was under way.

6.1 History

Excavation of Panel 1 began in May 1986 with the mining of the access entries. Initially, the disposal rooms and drifts were developed as pilot drifts that were later excavated to nominal operational dimensions of 13 ft (4 m) high, 33 ft (10 m) wide, and 300 ft (91 m) long. Room 1 was completed to these dimensions in August 1986, and pilot drifts for Rooms 2 and 3 were excavated in January and February 1987. Rooms 2 and 3 were completed in February and March 1988, and Rooms 4 through 7 were completed in May 1988. Four short access drifts designed to lead to smaller test alcoves were excavated north off the S-1600 drift and Rooms 4-7 in June 1989. Only the access drifts to the alcoves were completed; the alcoves themselves were not excavated. Panel 1 waste emplacement (in Rooms 1, 2, 3, 7, adjacent areas of S 1600, and all of S-1950) was completed during a prior reporting period, and the panel is closed to all access. The Panel 1 access entries, S-1600 and S-1950, which extend from the E-300 drift to the isolation walls, remain open, and the instrumentation in this area continues to be maintained and monitored.

Excavation of the Panel 2 waste disposal area began in September 1999 with the mining of access entries. Initially, the disposal rooms and drifts were developed as pilot drifts that were trimmed to finished dimensions. Room 1 was completed in January 2000, and pilot drifts for Rooms 2 and 3 were excavated in February 2000. Pilot drifts were completed for Rooms 4 through 6 in April 2000. The pilot drift for Room 7 was excavated in May 2000. All the rooms were excavated to final dimensions by August 2000. Waste emplacement in Panel 2 was completed during a prior reporting period, and the panel is closed to all access. The Panel 2 access entries, S-2150 and S-2520, which extend from the E-300 drift to the isolation walls, remain open, and the instrumentation in this area continues to be maintained and monitored.

Excavation of Panel 3 waste disposal rooms began in May 2002 with the mining of access entries to Panel 3. As with Panel 2, initially, the disposal rooms and drifts were developed as pilot drifts that were trimmed to finished dimensions. All the rooms were excavated to final dimensions by the end of March 2004. Waste emplacement in Panel 3 was completed in February 2007. Substantial barriers and bulkheads were installed in the exhaust and intake drifts of Panel 3 to prevent access into the panel and to isolate it from the ventilation circuit.

Panel 4 access drift mining began in January 2005. The disposal rooms were initially developed as pilot drifts and were later trimmed to final dimensions. Mining was completed by June 2006. Waste emplacement in Panel 4 was completed in March 2009. Substantial barriers and bulkheads were installed in the exhaust and intake drifts of Panel 4 to prevent access into the panel and to isolate it from the ventilation circuit.

Waste was being emplaced in Panel 5, Room 7 and in Panel 6, Room 7.

Panel 7 mining activities were underway.

6.2 Modifications to Excavations and Ground Control Activities

Routine maintenance and ground control activities in the form of trimming, scaling, rock bolt replacement, and installing wire mesh were performed on ribs, floor, and roof throughout accessible areas of the disposal panels. Table 6-1 summarizes the ground control activities performed in the disposal panels during this reporting period.

6.3 Instrumentation

There were no changes to the Panel 6 instrumentation layout. Convergence monitoring continued in all accessible areas up to the time that the waste stack front passed the instrument location. Remote monitoring of extensometers continues.

Schematics of the geotechnical instrumentation layout in Panels 3, 4, 5, and 6 are shown in Figure 6-1 through Figure 6-3.

Table 6-1 – Summary of Modifications and Ground Control Activities in the Waste Disposal Area from July 1, 2010 to June 30, 2011

Location	Work Performed
Panel 5	Tension fracture bolted with 12 ft resin-anchored bolts

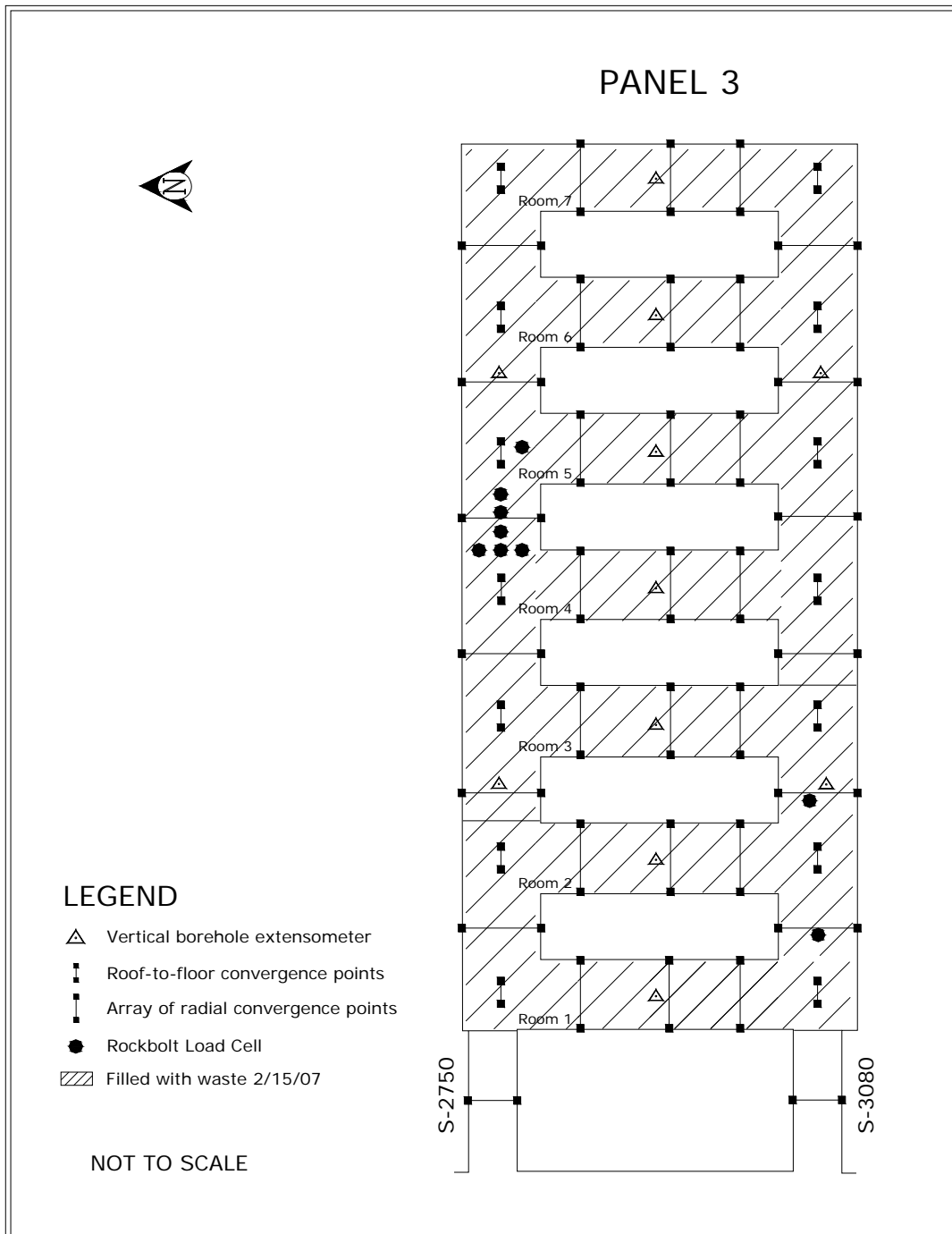

Figure 6-1 – Location of Panel 3 Geotechnical Instruments

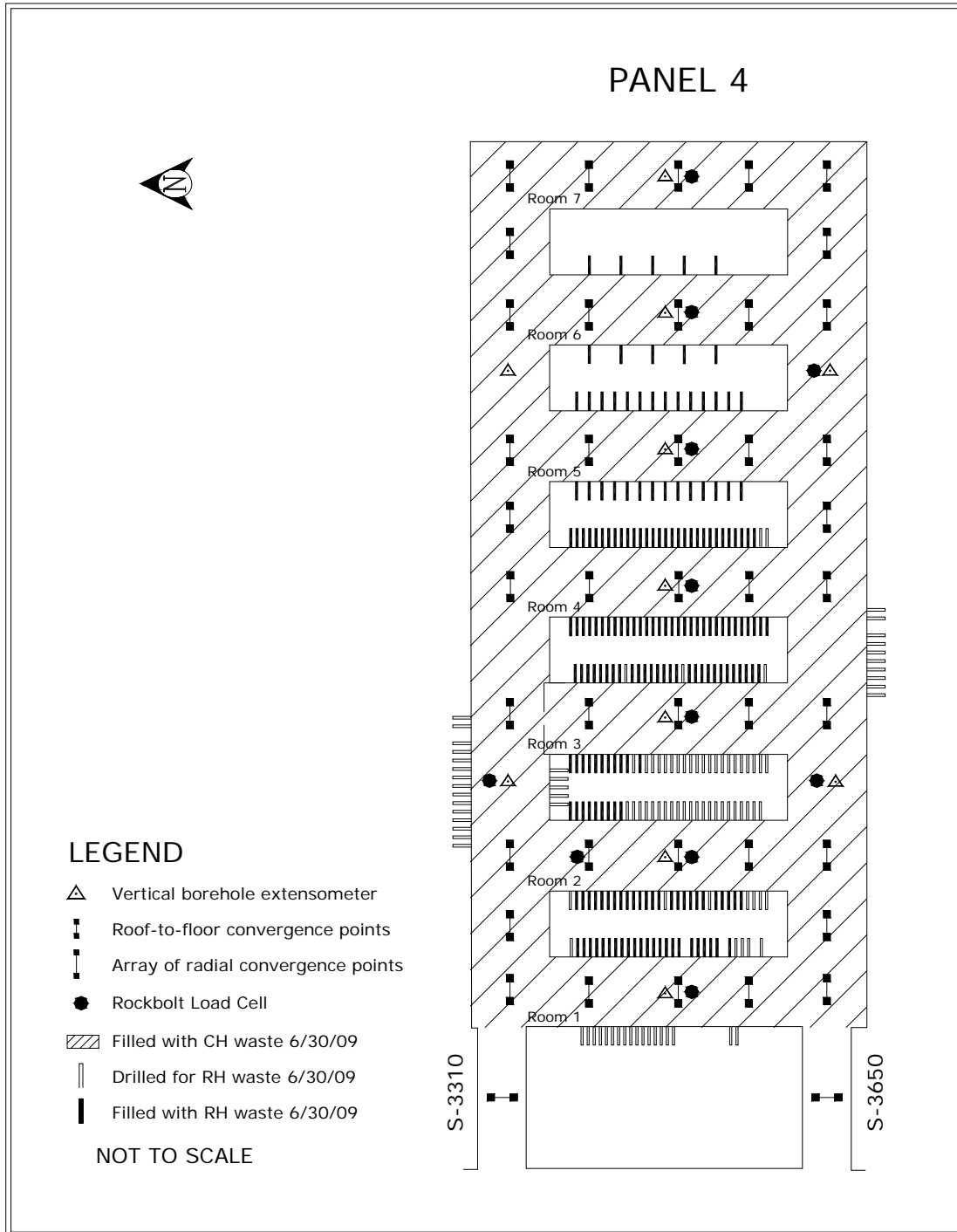

Figure 6-2 – Location of Panel 4 Geotechnical Instruments

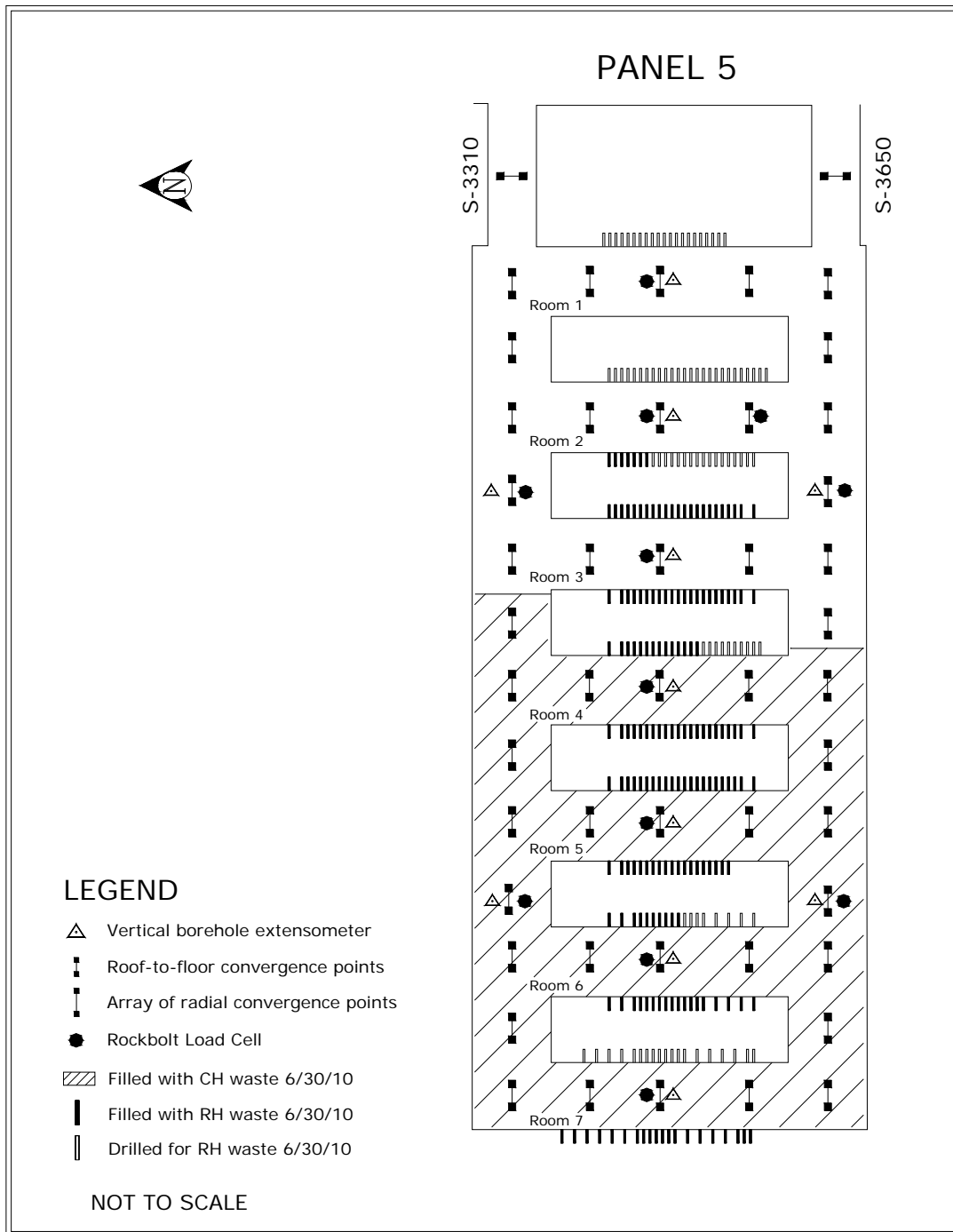

Figure 6-3 – Location of Panel 5 Geotechnical Instruments

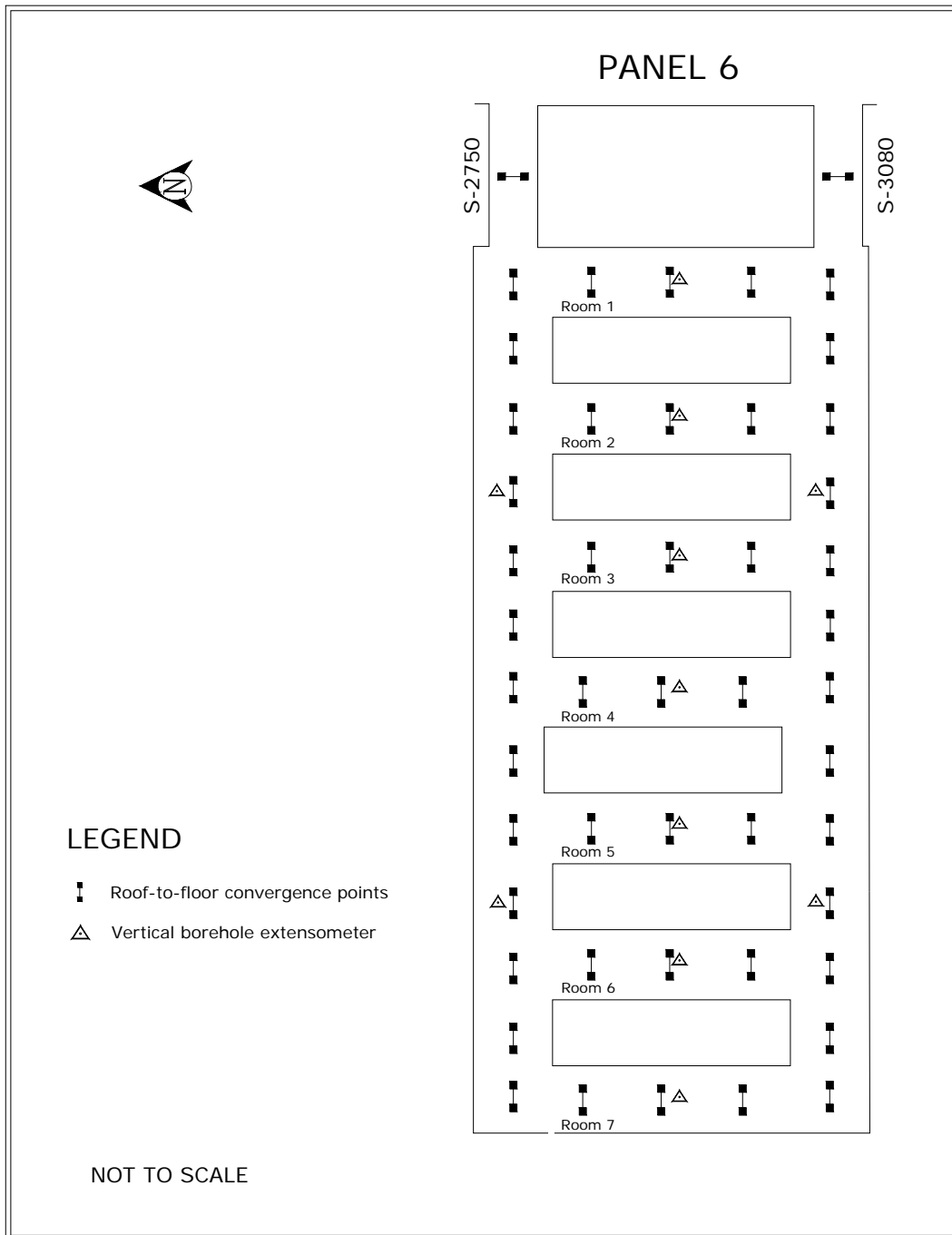

Figure 6-4 – Location of Panel 6 Geotechnical Instruments

6.4 Excavation Performance

Waste handling activities in Panels 1-5 have been completed, and geotechnical monitoring inside these panels has been discontinued. Extensometers in Panel 4 continue to be read remotely until the loss of communication with instruments behind the panel closure.

In accessible underground areas, horizontal and vertical convergence rates, calculated at the center of each of the rooms, were compared between this and the previous reporting period. Generally, convergence rates have declined from initial post-mining levels. Localized increases occur with seasonal creep trends, the presence of continuous anhydrite stringers, and coincident with adjacent mining activities. These increases are addressed, where necessary, with additional ground support selected for conditions prevailing at the specific location of installation.

6.5 Analysis of Extensometer and Convergence Point Data

Geotechnical instrumentation is installed in each disposal room and at select locations in the panel access drifts. As anticipated, these installations showed a general decrease in room closure rate and roof beam deformation with time. At some locations, deformation rates increased as roof sag and roof beam deterioration developed. Supplemental ground control support was installed in these areas and has subsequently reduced the observed rates.

Although Panels 1 through 4 are closed, convergence monitoring continues in the panel entries between E-300 and the explosion isolation walls (Panels 1 and 2) and substantial and isolation barriers (Panels 3 and 4). The exception is the Panel 4 intake drift (S3650) which is closed to access due to elevated VOC levels. The monitoring results indicate a steady long-term trend.

Panel 5 convergence monitoring indicated a stabilized rate in accessible locations until closure.

Panel 6 convergence data rates appear to remain elevated after floor trimming, particularly in the northern and eastern portions of the panel. Designed ground support consists of 5 foot-long resin anchored rock bolts, which provide a stiffening effect to the lower portion of the roof beam. Observation holes indicate that larger separations along anhydrite stringers are occurring above the anchorage zone, where the stress has been redirected. 12 ft resin anchored rock bolts were installed during this reporting period to counter the beam expansion along anhydrite stringers, and convergence monitoring indicates some success with this approach.

Panel 7 mining activities were underway at the end of this reporting period. No stable data was yet available for those areas.

7.0 GEOSCIENCE PROGRAM

The Geoscience Program confirms the suitability of the site through the collection of various geologic data and excavation characteristics from the underground. These include the inspection of open observation holes for fractures (separations) and offsets (lateral displacements) in roof beams and the mapping of fracture development on roof surfaces. Data collected through these activities support the design and evaluation of ground support systems.

During this reporting period, the following activities were performed:

- Observation hole inspections
- Fracture mapping

Fracture development in the roof is primarily caused by the concentration of compressive stresses in the roof beam and is influenced by the size and shape of the excavation and the stratigraphy in the immediate vicinity of the opening. In a thick roof beam, pillar deformations induce lateral compressive stresses into the immediate roof and floor. With time, the buildup of stress causes differential movement along stratigraphic boundaries. This differential movement is identified as offsets in observation holes and by the bends in failed rock bolts. Large strains associated with lateral movements can induce fracturing in the roof, which is frequently seen near the ribs; however, this process may take a long time (years) to develop.

At the upper repository horizon, clay or anhydrite stringers exert significant influence over the effective thickness of the roof beam. The presence of these stringers causes the roof beam to behave as a series of thin independent beams. Little or no tensile support is provided across the stringer interface. As horizontal end-loading continues, each beam can deflect downward causing a tensile fracture to develop along the bottom of the beam. These tensile fractures can develop in relatively new excavations soon after separation occurs along the stringer interface.

The location and initiation of interface separation is also influenced by the dip of the rock layers. The roofs and floors of the disposal panels are mined level through the sloping beds. At some locations, this may result in a significant difference in roof beam thickness from one side of the excavation to the other. Areas with the thinnest beam are the most likely to develop separations and subsequent fracturing.

7.1 Observation Hole Inspections

Geotechnical observation holes are drilled at various locations throughout the underground facility. A location may contain one or more holes arranged in an array. These holes are drilled to depths that allow the monitoring of fracture development and offsetting and are inspected for the development of those features. Roof observation holes usually extend up past clays G and H (Figure 7-1 and Figure 7-2).

The clay seams nearest the excavation surfaces define the immediate roof beam. The roof beam is bounded by Clay G in most of the access drifts and Panels 1 and 2. Some areas, such as the Salt Shaft Station, portions of the E-0 and E-140 drifts, the south mains south of S-2620, and Panels 3, 4, 5, and 6 are excavated to Clay G and so have roof beams bounded by Clay H.

The offset in an observation hole is determined by visually estimating the degree of occlusion. The direction of offset along clay seams is observed as the movement of the strata nearer to the observer relative to the strata farther away. Typically, the nearer strata move toward the center of the excavation (Figure 7-3 and Figure 7-4). Based on previous observations in the underground, the magnitude of offset is usually greater in

holes located near ribs than in those located along excavation centerlines. Offsetting along the clay layers is observable until total offset is reached or visibility is obstructed by intervening offsets at other clay seams or fractures.

Observation holes are inspected for fractures, using an aluminum rod with a flattened steel wire probe attached to one end perpendicular to the rod (referred to as a "scratch rod"). Fractures and clay seams are located by moving the probe along the inside of the hole until it is snagged in one of these features. Depth to each feature is recorded, as is the magnitude of separations encountered. A fiber scope camera is occasionally used in addition to the scratch rod to visually document features of interest in a hole.

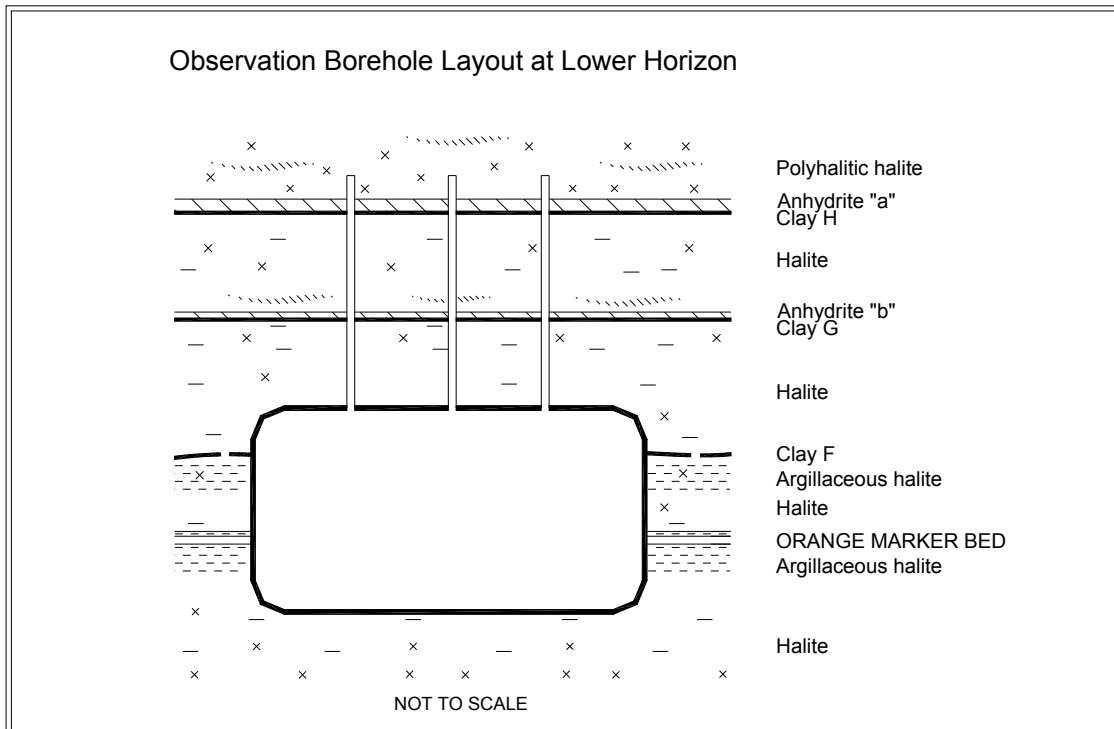

Figure 7-1 – Example of Observation Hole Layout at Lower Horizon

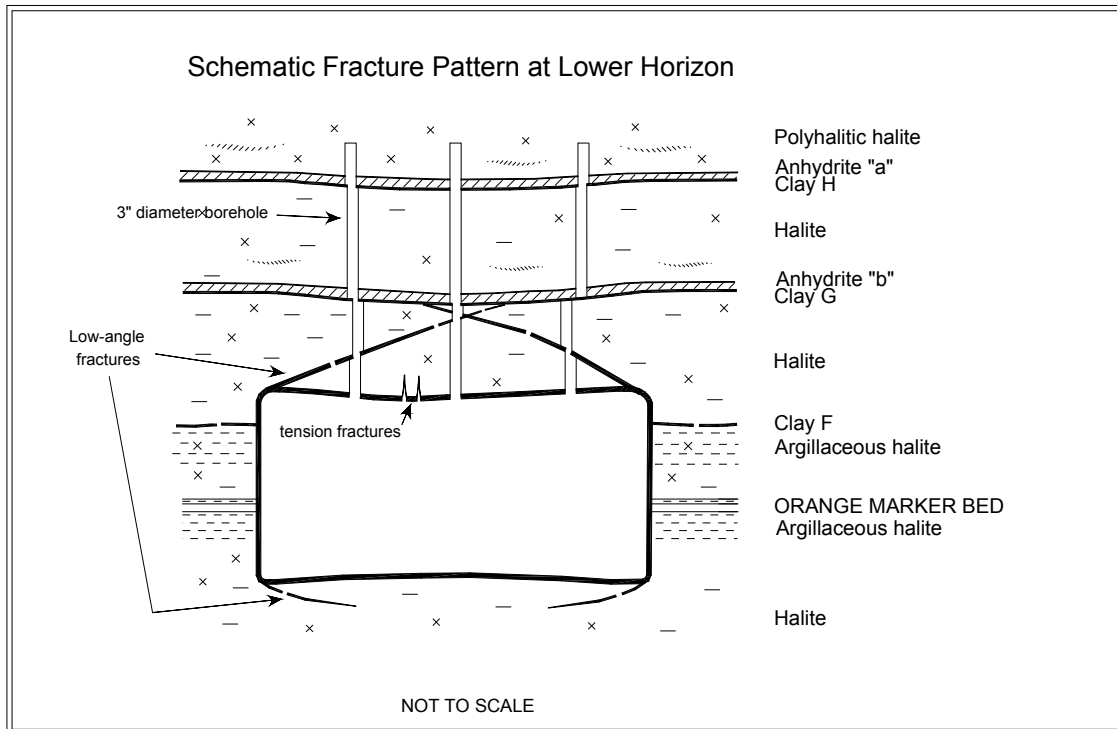

Figure 7-2 – Example of Observation Hole Layout at Upper Horizon

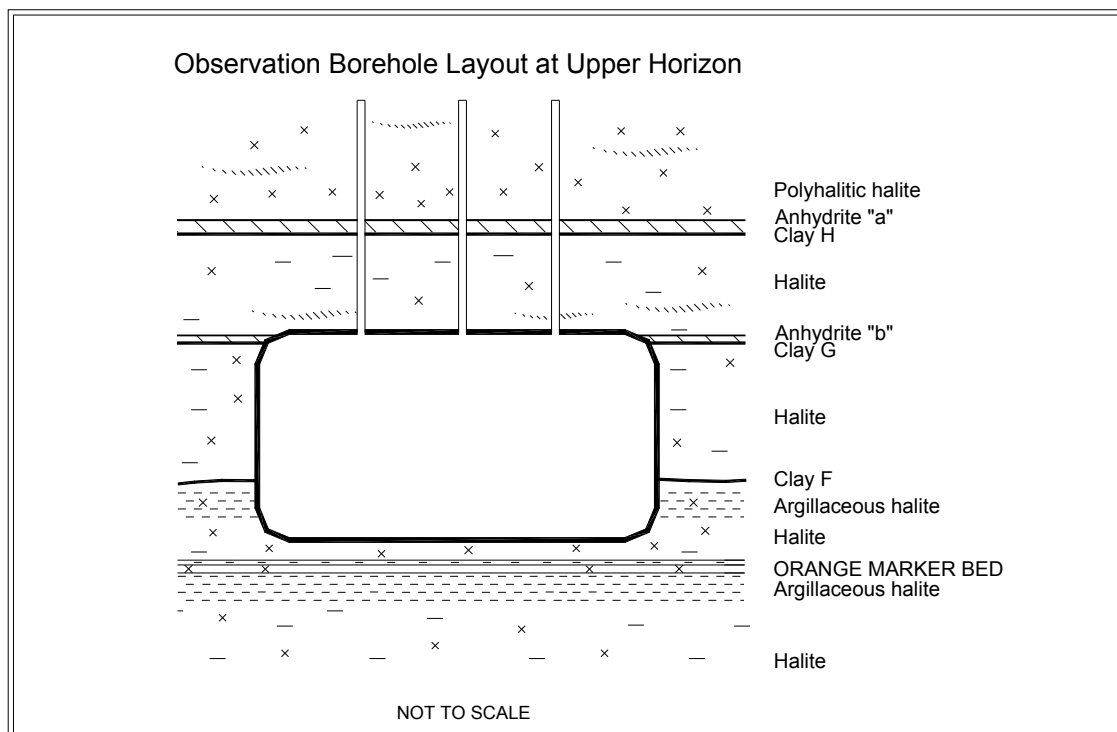

Figure 7-3 – Typical Fracture Patterns at Lower Horizon

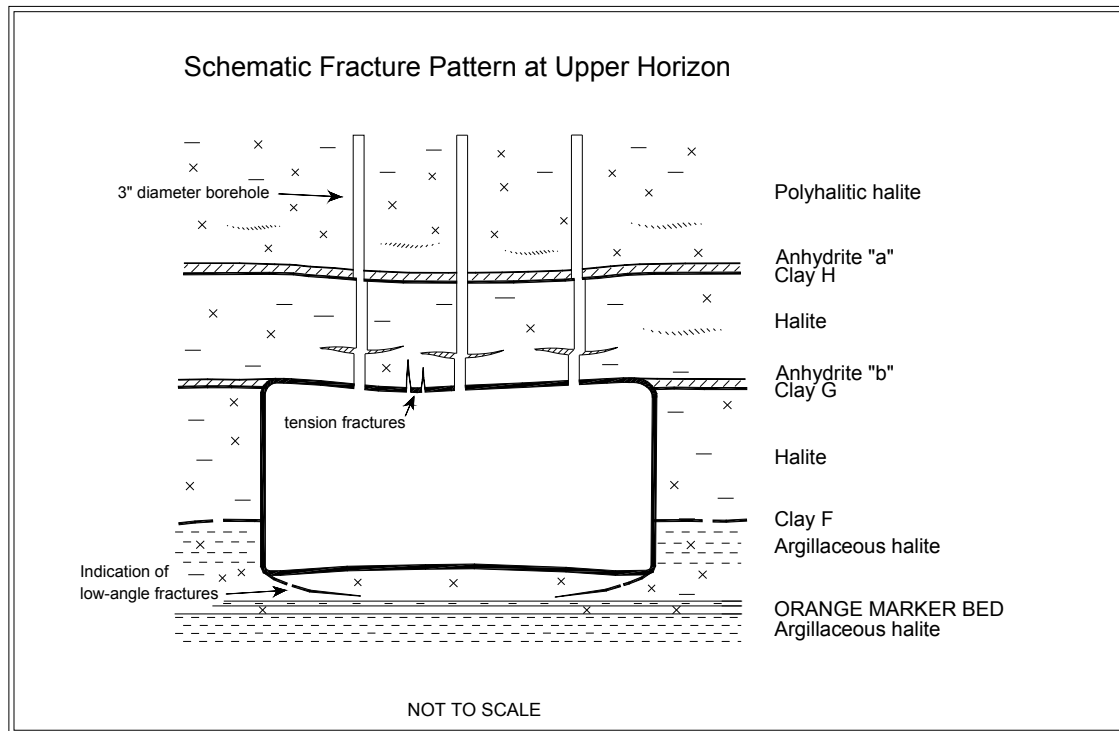

Figure 7-4 – Typical Fracture Patterns at Upper Horizon

The separation and offset data observed in accessible observation holes in the back are presented in the supporting data document for this report. Forty-seven accessible holes were monitored in Panel 5, and 47 in Panel 6. In Panel 6, the greatest separations were associated with Clay H and Anhydrite "a." Nineteen holes in Panel 6 had fractures associated with anhydrite stringers in the lower portion (first 3 feet) of the roof beam. Thirty-eight of 47 holes in Panel 6 and sixteen of the 47 holes in Panel 7 showed some offset.

7.2 Fracture Mapping

Routine mapping documents the progression of fractures in the roof exposed on the excavation surfaces of the drifts and rooms in the underground repository. The fracture surveys are generally performed on an annual basis, and the fracture maps are updated. The fracture maps facilitate the analysis of strain in the immediate roof-beam, because they document the development and propagation of fractures through time. The supporting data document contains fracture maps for Panels 6 and 7. During this reporting period, fractures were mapped in Panels 6 and 7.

8.0 SUMMARY

At the inception of WIPP, criteria were developed that address the design requirements (DOE, 1984). They pertained to all aspects of the mined facility and its operation as a pilot plant for the demonstration of technical and operational methods for permanent disposal of contact-handled and remote-handled TRU waste. In 1994, as the WIPP focus moved toward the permanent disposal of TRU waste, these design requirements were reassessed and replaced by a new set of requirements called system design descriptions. Table 8-1 shows the comparison of these design requirements with conditions actually observed in the underground from July 2010 through June 2011.

Normal drift and room maintenance continued during this reporting period with rib, roof, and floor scaling and trimming in various locations, and rock bolts and wire mesh installed as needed. Supplemental ground control systems consisting of resin-anchored bolts were installed in select locations. Some of these supplemental systems also included roof mats.

New geomechanical instrumentation was installed in Panel 7 and its access drifts, as well as in various locations throughout the repository to replace mined-out instruments. Monitoring no longer continues in non-accessible areas except in Panel 4. All accessible areas of the underground are connected to data-loggers or are monitored manually.

The *in situ* performance of the excavations generally continues to satisfy the appropriate design criteria, although specific areas are being identified where deterioration resulting from ageing must be addressed through routine maintenance and installation of engineered systems. This deterioration has been identified through the analysis of data acquired from geomechanical instrumentation and the Geoscience Program. If the planned life of some of the openings needs to be extended, changing the geometry of the access drifts (removing unstable roof beam or rib spalls, or milling the floor for added clearance), or additional ground control (roof removal, installing bolts, mesh, or straps) may be necessary. The ground conditions in the waste disposal area and associated waste transport routes continue to slowly deteriorate; however, routine ground control installations and maintenance continue to allow safe access in the underground facility.

In addition to underground instrumentation, qualitative assessments of fracture development are documented through mapping the underground repository and inspecting the observation holes. The information acquired from these programs provides early detection of ground deterioration, contributes to the understanding of the dynamic geomechanical processes in the WIPP underground, and aids in the design of effective ground control and support systems.

Table 8-1 – Comparison of Excavation Performance to System Design Requirements

Requirement	Comments
"The lining shall be designed for a hydrostatic pressure. . . ."	Water pressure observed on piezometers located behind the shaft liners remains below design levels.
"The key shall be designed to resist the lateral pressure generated by salt creep."	Geomechanical data from the Waste Shaft indicate that the shaft key is minimally loaded and is structurally stable. Visual inspections of all shaft keys do not indicate any deterioration due to creep loading.
"The key shall be designed to retain the rock formation and will be provided with chemical seal rings and a water collection ring with drains to prevent water from flowing down the unlined shaft from the lining above."	Shaft inspection observations and instrumentation show no indication of instability due to salt dissolution. No water has been observed flowing along the rock-liner interface.
"The underground waste disposal facilities shall be designed to provide space and adequate access for the underground equipment and temporary storage space to support underground operations."	Geomechanical instrument data and visual observations indicate that the current design provides adequate access and storage and disposal space. Ground control maintenance is performed as necessary to maintain access.
"Entries and subentries to the underground disposal area and the experimental areas shall be provided and sized for personnel safety, adequate air flow, and space for equipment."	Deformation of excavation remains within the required limits. Normal periodic maintenance consisting of rock bolting, wire meshing, trimming, and scaling continue throughout the repository. Areas such as the waste transport route undergo periodic floor trims in order to maintain adequate operating height.
"Geomechanical instrumentation shall be provided to measure the cumulative deformation of the rock mass surrounding mined drifts. . . ."	Geotechnical instrumentation is operated and maintained to meet this requirement. This annual report provides a summary and analysis of the geomechanical data.

9.0 REFERENCES

ASTM, 2006, E29-06b, Standard Practice for Using Significant Digits in Test Data to Determine Conformance with Specifications.

DOE, see U.S. Department of Energy.

Public Law 96-164, Department of Energy National Security and Military Applications of Nuclear Energy Authorization Act of 1980.

Title 40 CFR Part 191, "Environmental Radiation Protection Standards for Management and Disposal of Spent Nuclear Fuel, High-Level and Transuranic Radioactive Wastes."

Title 40 CFR Part 194, "Criteria for the Certification and Re-certification of the Waste Isolation Pilot Plant's Compliance with the 40 CFR Part 191 Disposal Regulations."

U.S. Environmental Protection Agency, 1998, "Criteria for the Certification and Recertification of the Waste Isolation Pilot Plant's Compliance with the Disposal

Regulations: Certification Decision," *Federal Register*, Vol. 63, No. 95, pp. 27354, May 18, 1998, Washington, DC

Holt, R. M., and D. W. Powers, 1990, *Geologic Mapping of the Air Intake Shaft at the Waste Isolation Pilot Plant*, DOE/WIPP 90-051, Waste Isolation Pilot Plant, Carlsbad, New Mexico.

Holt, R. M., and D. W. Powers, 1984, *Geotechnical Activities in the Waste Handling Shaft, Waste Isolation Pilot Plant (WIPP) Project, Southeastern New Mexico*, WTSD TME 038, Waste Isolation Pilot Plant, Carlsbad, New Mexico.

New Mexico Environment Department (NMED), 2010, Waste Isolation Pilot Plant Hazardous Waste Facility Permit, NM4890139088-TSDF, Santa Fe, New Mexico.

Powers, D. W., and R. M. Holt, 1993, *The Upper Cenozoic Gatuña Formation of Southeastern New Mexico*, New Mexico Geological Society Guidebook, 44th Field Conference, Carlsbad Region, New Mexico and West Texas, D. W. Love et al., Eds., pp 271–282.

Powers, D. W., and R. M. Holt, 1995, Gatuña Formation (Miocene to Pleistocene) *Geology and Paleohydrology*, prepared for Westinghouse Waste Isolation Division by International Technology Corporation, Albuquerque, New Mexico.

Powers, D. W., S. J. Lambert, S. E. Shaffer, L. R. Hill, and W. D. Weart, Eds., 1978, *Geological Characterization Report, Waste Isolation Pilot Plant (WIPP) Site, Southeastern New Mexico*, Vols. I and II, SAND 78 1596; Sandia National Laboratories, Albuquerque, New Mexico.

U.S. Department of Energy (DOE), 2000, *Brine Generation Study*, DOE/WIPP 00-2000, Waste Isolation Pilot Plant, Carlsbad, New Mexico.

U.S. Department of Energy (DOE), 1986a, *Interim Geotechnical Field Data Report*, DOE/WIPP 86-012, Waste Isolation Pilot Plant, Carlsbad, New Mexico.

U.S. Department of Energy (DOE), 1986b, *Waste Isolation Pilot Plant Design Validation Final Report*, DOE/WIPP 86-010; Prepared by Bechtel National, Inc., for the U.S. Department of Energy, San Francisco, California.

U.S. Department of Energy (DOE), 1986c, *Geotechnical Activities in the Exhaust Shaft*, DOE/WIPP 86-008, Waste Isolation Pilot Plant, Carlsbad, New Mexico.

U.S. Department of Energy (DOE), 1985, *Quarterly Geotechnical Field Data Report*, DOE/WIPP-221, Waste Isolation Pilot Plant, Carlsbad, New Mexico.

U.S. Department of Energy (DOE), 1984, *Design Criteria, Waste Isolation Pilot Plant (WIPP) Revised Mission Concept-IIA*, DOE/WIPP-071; Waste Isolation Pilot Plant, Carlsbad, New Mexico.

Working Copy

Geotechnical Analysis Report for July 2010 – June 2011
DOE/WIPP-12-3484, Vol. 1

U.S. Department of Energy (DOE), 1983, *Summary of the Results of the Evaluation of the WIPP Site and Preliminary Design Validation Program*, DOE/WIPP-161; Waste Isolation Pilot Plant, Carlsbad, New Mexico.