
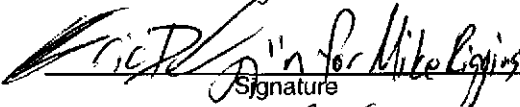

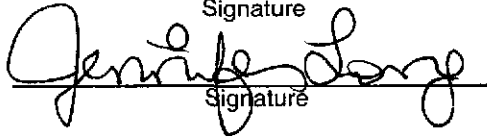


Appendix C

<p style="text-align: center;"><b>NUCLEAR WASTE MANAGEMENT PROCEDURE</b></p> <p><small>Sandia National Laboratories</small></p>	<h2 style="margin: 0;">Requirements Document Criteria</h2>	<p><b>Form Number: NP 19-1-2</b></p> <p><b>Page 1 of 1</b></p>																		
<p>1. <b>Software Name:</b> <u>BRAGFLO</u></p> <p>2. <b>Software Version:</b> <u>6.0</u></p> <p>3. <b>Document Version:</b> <u>6.0</u></p> <p>4. <b>ERMS #:</b> <u>545014</u></p> <p>Prior to sign-off of the RD, all items shall be appropriately addressed by the code sponsor so that "Yes" or "N/A" may be checked. Include this form as part of the RD.</p>																				
<p>5. <b>Functionality:</b> Are the functions that the software is to perform adequately identified? <input checked="" type="checkbox"/> Yes</p> <p>6. <b>Performance:</b> Are time-related software operations issues, e.g., speed, recovery time, or response time identified, where applicable as based on the code functionality? <input type="checkbox"/> Yes <input checked="" type="checkbox"/> N/A</p> <p>7. <b>Design Constraints:</b> Are elements that will restrict design options identified? <input checked="" type="checkbox"/> Yes</p> <p>8. <b>Attributes (non-time-related):</b> Are the following identified, where applicable as based on the code functionality:</p> <table style="width:100%; border: none;"> <tr> <td style="padding-left: 20px;">portability?</td> <td style="text-align: right;"><input type="checkbox"/> Yes</td> <td style="text-align: right;"><input checked="" type="checkbox"/> N/A</td> </tr> <tr> <td style="padding-left: 20px;">acceptance criteria?</td> <td style="text-align: right;"><input checked="" type="checkbox"/> Yes</td> <td></td> </tr> <tr> <td style="padding-left: 20px;">maintainability?</td> <td style="text-align: right;"><input type="checkbox"/> Yes</td> <td style="text-align: right;"><input checked="" type="checkbox"/> N/A</td> </tr> </table> <p>9. <b>External Interfaces:</b> Are the following interactions identified, where applicable as based on the code functionality:</p> <table style="width:100%; border: none;"> <tr> <td style="padding-left: 20px;">People?</td> <td style="text-align: right;"><input checked="" type="checkbox"/> Yes</td> <td style="text-align: right;"><input type="checkbox"/> N/A</td> </tr> <tr> <td style="padding-left: 20px;">Hardware?</td> <td style="text-align: right;"><input checked="" type="checkbox"/> Yes</td> <td style="text-align: right;"><input type="checkbox"/> N/A</td> </tr> <tr> <td style="padding-left: 20px;">Software?</td> <td style="text-align: right;"><input checked="" type="checkbox"/> Yes</td> <td style="text-align: right;"><input type="checkbox"/> N/A</td> </tr> </table> <p>10. <b>Completeness:</b> Are the requirements complete? <input checked="" type="checkbox"/> Yes</p> <p>11. <b>Verifiability:</b> Can meeting the requirements be verified? <input checked="" type="checkbox"/> Yes</p> <p>12. <b>Consistency:</b> Are requirements consistent with each other? <input checked="" type="checkbox"/> Yes</p> <p>13. <b>Technical Feasibility:</b> Are the requirements technically feasible and can they result in a useable code? <input checked="" type="checkbox"/> Yes</p>			portability?	<input type="checkbox"/> Yes	<input checked="" type="checkbox"/> N/A	acceptance criteria?	<input checked="" type="checkbox"/> Yes		maintainability?	<input type="checkbox"/> Yes	<input checked="" type="checkbox"/> N/A	People?	<input checked="" type="checkbox"/> Yes	<input type="checkbox"/> N/A	Hardware?	<input checked="" type="checkbox"/> Yes	<input type="checkbox"/> N/A	Software?	<input checked="" type="checkbox"/> Yes	<input type="checkbox"/> N/A
portability?	<input type="checkbox"/> Yes	<input checked="" type="checkbox"/> N/A																		
acceptance criteria?	<input checked="" type="checkbox"/> Yes																			
maintainability?	<input type="checkbox"/> Yes	<input checked="" type="checkbox"/> N/A																		
People?	<input checked="" type="checkbox"/> Yes	<input type="checkbox"/> N/A																		
Hardware?	<input checked="" type="checkbox"/> Yes	<input type="checkbox"/> N/A																		
Software?	<input checked="" type="checkbox"/> Yes	<input type="checkbox"/> N/A																		
<p>14. <u>Martin Nemer</u> <b>Code Team/Sponsor's Name (print)</b></p>	<p> Signature</p>	<p><u>1/26/07</u> Date</p>																		
<p>15. <u>Michael Riggins</u> <b>Technical Reviewer's Name (print)</b></p>	<p> Signature</p>	<p><u>1/26/07</u> Date</p>																		
<p>16. <u>MOO Y. LEE</u> <b>Responsible Manager's Name (print)</b></p>	<p> Signature</p>	<p><u>1/30/07</u> Date</p>																		
<p>17. <u>Jennifer Long</u> <b>SCM Coordinator's Name (print)</b></p>	<p> Signature</p>	<p><u>2/5/07</u> Date</p>																		

**Key for check boxes above:**

Check <b>Yes</b> for each item reviewed and found acceptable
Check <b>N/A</b> for items not applicable

Information Only

Appendix D

<p style="text-align: center;"><b>NUCLEAR WASTE MANAGEMENT PROCEDURE</b></p> <p>Sandia National Laboratories</p>	<h2 style="margin: 0;">Verification and Validation Plan Criteria</h2>	<p><b>Form Number: NP 19-1-3</b></p> <p><b>Page 1 of 1</b></p>
<p>1. <b>Software Name:</b> <u>BRAGFLO</u></p> <p>2. <b>Software Version:</b> <u>6.0</u></p> <p>3. <b>Document Version:</b> <u>6.0</u></p> <p>4. <b>ERMS #:</b> <u>545014</u></p> <p>Prior to sign-off of the VVP, all items shall be appropriately addressed by the code sponsor so that "Yes" or "N/A" may be checked. Include this form as part of the VVP.</p>		
<p>5. <b>Sufficient Test Cases</b> <span style="float: right;"><input checked="" type="checkbox"/> Yes</span>                  Does the VVP identify sufficient test cases and acceptance criteria to ensure the final software and end product satisfies the requirements of the RD? (Check Yes if peer review is identified to fulfill the validation requirements)</p> <p>6. <b>Adequacy of Test Cases</b> <span style="float: right;"><input checked="" type="checkbox"/> Yes</span>                  Do the test cases demonstrate that the code adequately performs all intended functions and produces valid results for problems encompassing the range of permitted usage?</p> <p>7. <b>Operational Control</b> <span style="float: right;"><input checked="" type="checkbox"/> Yes</span>                  If the software is used for operational control, do tests demonstrate required performance over the range of operation of the controlled function or process?</p> <p>8. <b>Unintended Functions</b> <span style="float: right;"><input checked="" type="checkbox"/> Yes</span>                  Do the test cases show that the code does not perform any unintended function that either by itself or in combination with other functions can degrade the intended outcomes of the software?</p> <p>9. <b>Test Result Validation.</b> (check one or more, where applicable as based on code functionality)                  The test results will be compared to the following:</p> <ul style="list-style-type: none"> <li>- hand calculations, <span style="float: right;"><input checked="" type="checkbox"/> Yes <input type="checkbox"/> N/A</span></li> <li>- manual inspection, <span style="float: right;"><input checked="" type="checkbox"/> Yes <input type="checkbox"/> N/A</span></li> <li>- calculations using comparable proven problems, <span style="float: right;"><input checked="" type="checkbox"/> Yes <input type="checkbox"/> N/A</span></li> <li>- empirical data and information from confirmed published data and correlation's and/or technical literature, <span style="float: right;"><input checked="" type="checkbox"/> Yes <input type="checkbox"/> N/A</span></li> <li>- other validated software of similar purpose, <span style="float: right;"><input checked="" type="checkbox"/> Yes <input type="checkbox"/> N/A</span></li> <li>- other independent software of similar purpose. <span style="float: right;"><input checked="" type="checkbox"/> Yes <input type="checkbox"/> N/A</span></li> </ul> <p>A documented peer review will be performed.                  Do the test cases describe how the code results will be validated? <span style="float: right;"><input checked="" type="checkbox"/> Yes <input type="checkbox"/> N/A</span></p> <p>10. <b>Does the VVP specify the following, where applicable as based on code functionality?</b></p> <ul style="list-style-type: none"> <li>(a) required tests and test sequence <span style="float: right;"><input checked="" type="checkbox"/> Yes <input type="checkbox"/> N/A</span></li> <li>(b) required ranges of input parameters <span style="float: right;"><input checked="" type="checkbox"/> Yes <input type="checkbox"/> N/A</span></li> <li>(c) identification of the stages at which testing is required <span style="float: right;"><input checked="" type="checkbox"/> Yes <input type="checkbox"/> N/A</span></li> <li>(d) criteria for establishing test cases <span style="float: right;"><input checked="" type="checkbox"/> Yes <input type="checkbox"/> N/A</span></li> <li>(e) requirements for testing logic branches <span style="float: right;"><input checked="" type="checkbox"/> Yes <input type="checkbox"/> N/A</span></li> <li>(f) requirements for hardware integration <span style="float: right;"><input checked="" type="checkbox"/> Yes <input type="checkbox"/> N/A</span></li> <li>(g) anticipated output values <span style="float: right;"><input checked="" type="checkbox"/> Yes <input type="checkbox"/> N/A</span></li> <li>(h) acceptance criteria <span style="float: right;"><input checked="" type="checkbox"/> Yes <input type="checkbox"/> N/A</span></li> </ul> <p>11. <b>Installation and Regression Testing</b> <span style="float: right;"><input checked="" type="checkbox"/> Yes</span>                  Are test cases which are suitable for installation testing and regression testing identified in the set of verification and validation test cases?</p>		
<p>12. <u>Martin Nemer</u> <span style="float: right;"><u>1/26/07</u></span>                  Code Team/Sponsor's Name (print) <span style="float: right;">Signature</span> <span style="float: right;">Date</span></p> <p>13. <u>Michael Riggins</u> <span style="float: right;"><u>1/26/07</u></span>                  Technical Reviewer's Name (print) <span style="float: right;">Signature</span> <span style="float: right;">Date</span></p> <p>14. <u>MOO Y. LEE</u> <span style="float: right;"><u>1/30/07</u></span>                  Responsible Manager's Name (print) <span style="float: right;">Signature</span> <span style="float: right;">Date</span></p> <p>15. <u>Jennifer Long</u> <span style="float: right;"><u>2/5/07</u></span>                  SCM Coordinator's Name (print) <span style="float: right;">Signature</span> <span style="float: right;">Date</span></p>		
<p><b>Key for check boxes above:</b></p> <p>Check <b>Yes</b> for each item reviewed and found acceptable</p> <p>Check <b>N/A</b> for items not applicable, where applicable as based on code functionality</p>		

Information Only

**WIPP PA**

**REQUIREMENTS DOCUMENT**

**&**

**VERIFICATION AND VALIDATION PLAN**

**For**

**BRAGFLO (Version 6.0)**

**Document Version 6.0**  
**ERMS # 545014**  
**January 15, 2007**

**Information Only**

## TABLE OF CONTENTS

<u>Section</u>	<u>Page</u>
1.0 INTRODUCTION.....	8
1.1 Software Identifier .....	8
1.2 Points of Contact.....	8
1.3 Description.....	8
1.4 Changes Required for BRAGFLO 6.0 From 5.0 .....	9
2.0 REQUIREMENTS.....	9
2.1 Functional Requirements .....	9
2.2 Performance Requirements.....	12
2.3 Attribute Requirements.....	12
2.4 External Interface Requirements.....	12
2.5 Other Requirements .....	12
3.0 DESIGN OVERVIEW.....	12
3.1 I/O Description.....	12
3.2 Context Diagram.....	13
3.3 Design Constraints.....	13
4.0 ADDITIONAL FUNCTIONALITY TO BE TESTED.....	14
5.0 FUNCTIONALITY NOT TESTED.....	14
6.0 TESTING ENVIRONMENT.....	16
7.0 STATIC TESTING.....	16
8.0 COVERAGE TESTING.....	17
9.0 FUNCTIONAL TESTING.....	17
9.1 Test Case #1. Pressure drawdown with radial grid.....	19
9.1.1 Test Objective .....	19
9.1.2 Test Procedure.....	19
9.1.3 Input Files .....	20
9.1.4 Acceptance Criteria.....	20
9.2 Test Case #2. Horizontal one-dimensional infiltration.....	25
9.2.1 Test Objective .....	25
9.2.2 Test Procedure.....	26
9.2.3 Input Files .....	26
9.2.4 Acceptance Criteria.....	26
9.3 Test Case #3. Horizontal 1 D infiltration, with Dirichlet boundary condition.....	31
9.3.1 Test Objective .....	31
9.3.2 Test Procedure .....	31
9.3.3 Input Files .....	32
9.3.4 Acceptance Criteria.....	32
9.4 Test Case #4. Two-dimensional infiltration.....	33
9.4.1 Test Objective .....	33
9.4.2 Test Procedure.....	34
9.4.3 Input Files .....	34
9.4.4 Acceptance Criteria.....	34
9.5 Test Case #5. Two-dimensional, two-phase flow with gas injection.....	39
9.5.1 Test Objective .....	39

9.5.2 Test Procedure.....	39
9.5.3 Input Files .....	39
9.5.4 Acceptance Criteria.....	40
9.6 Test Case #6. Two-dimensional WIPP preliminary performance assessment calculation.....	46
9.6.1 Test Objective .....	46
9.6.2 Test Procedure.....	46
9.6.3 Input Files .....	46
9.6.4 Acceptance Criteria.....	47
9.7 Test Case #7. FEP baseline calculations, E1 scenario. Total of 20 BRAGFLO runs.....	65
9.7.1 Test Objective .....	65
9.7.2 Test Procedure.....	65
9.7.3 Input Files .....	66
9.7.4 Acceptance Criteria.....	66
9.8 Test Case #8. Well Production at Specified Bottom Hole Pressure .....	67
9.8.1 Test Objective .....	67
9.8.2 Test Procedure.....	68
9.8.3 Input Files .....	68
9.8.4 Acceptance Criteria.....	69
9.9 Test Case #9. Heterogeneous Reservoir Conditions.....	73
9.9.1 Test Objective .....	73
9.9.2 Test Procedure.....	74
9.9.3 Input Files .....	74
9.9.4 Acceptance Criteria.....	75
9.10 Test Case #10. No Flow Boundary Conditions.....	78
9.10.1 Test Objective .....	78
9.10.2 Test Procedure.....	79
9.10.3 Input Files .....	79
9.10.4 Acceptance Criteria.....	80
9.11 Test Case #11. Pressure and Density of Water Column in Equilibrium.....	82
9.11.1 Test Objective .....	82
9.11.2 Test Procedure.....	83
9.11.3 Input Files .....	84
9.11.4 Acceptance Criteria.....	84
9.12 Test Case #12. Direct Brine Release.....	85
9.12.1 Test Objective .....	85
9.12.2 Test Procedure.....	85
9.12.3 Input Files .....	85
9.12.4 Acceptance Criteria.....	86
9.13 Test Case #13. Error Reporting for Incorrect Number of Waste Material Regions.....	87
9.13.1 Test Objective .....	87
9.13.2 Test Procedure.....	87
9.13.3 Input Files .....	87
9.13.4 Acceptance Criteria.....	87
9.14 Test Case #14. Additional Iron and MgO Chemistry. ....	88
9.14.1 Test Objective .....	88

9.14.2 Test Procedure.....	89
9.14.3 Input Files .....	89
9.14.4 Acceptance Criteria.....	89
10.0 INSTALLATION AND REGRESSION TESTING .....	102
11.0 REFERENCES .....	102

## LIST OF FIGURES

FIGURE 3.1 DATA FLOW FOR BRAGFLO .....	14
FIGURE 9.1.1 ANALYTICAL SOLUTION FOR TEST CASE #1: PRESSURE DRAWDOWN AT SHUT-IN TIME, $T = 5000$ s .....	21
FIGURE 9.1.2 ANALYTICAL SOLUTION FOR TEST CASE #1: PRESSURE DRAWDOWN HISTORY AT DISTANCE FROM WELL OF $R = 100.4$ M .....	22
FIGURE 9.2.1 ANALYTICAL SOLUTION FOR TEST CASE #2: SATURATION PROFILES ALONG TUBE AT VARIOUS TIMES FOR ONE-DIMENSIONAL INFILTRATION PROBLEM .....	28
FIGURE 9.4.1 COMPARISON OF TOUGH AND EXPERIMENTAL RESULTS FOR TEST CASE #4, TWO-DIMENSIONAL INFILTRATION, AT DISTANCE $X = 0.19$ M .....	36
FIGURE 9.4.2 COMPARISON OF TOUGH AND EXPERIMENTAL RESULTS FOR TEST CASE #4, TWO-DIMENSIONAL INFILTRATION, AT DISTANCE $X = 1.39$ M .....	37
FIGURE 9.5.1 TOUGH RESULTS FOR TEST CASE #5, GAS INJECTION. GAS PRESSURES IN HORIZONTAL CROSS SECTION THROUGH THE WELL AT TIME $T = 1.0 \times 10^7$ s .....	41
FIGURE 9.5.2 TOUGH RESULTS FOR TEST CASE #5, GAS INJECTION. GAS SATURATIONS IN HORIZONTAL CROSS SECTION THROUGH THE WELL AT TIME $T = 1.0 \times 10^7$ s .....	42
FIGURE 9.5.3 TOUGH RESULTS FOR TEST CASE #5, GAS INJECTION. GAS PRESSURES IN VERTICAL CROSS SECTION THROUGH THE WELL AT TIME $T = 1.0 \times 10^7$ s .....	43
FIGURE 9.5.4 TOUGH RESULTS FOR TEST CASE #5, GAS INJECTION. GAS SATURATIONS IN VERTICAL CROSS SECTION THROUGH THE WELL AT TIME $T = 1.0 \times 10^7$ s .....	44
FIGURE 9.6.1A POROSITY SURFACE USED IN BRAGFLO FOR WASTE WITHOUT BACKFILL; PRESSURE VS TIME; TIME SCALE 0-10,000 YEARS. ....	61
FIGURE 9.6.1B POROSITY SURFACE USED IN BRAGFLO FOR WASTE WITHOUT BACKFILL; POROSITY VS TIME; TIME SCALE 0-10,000 YEARS. ....	62
FIGURE 9.6.2A POROSITY SURFACE USED IN BRAGFLO FOR WASTE WITHOUT BACKFILL; PRESSURE VS TIME; TIME SCALE 0-1200 YEARS. ....	63
FIGURE 9.6.2B POROSITY SURFACE USED IN BRAGFLO FOR WASTE WITHOUT BACKFILL; POROSITY VS TIME; TIME SCALE 0-1200 YEARS. ....	64
FIGURE 9.8.1 RESULTS FROM TOUGH28W RUN ON TEST CASE #8. RESERVOIR PRESSURE RESPONSE FOR PRESSURE-SPECIFIED DELIVERABILITY .....	69
FIGURE 9.8.2 RESULTS FROM TOUGH28W RUN ON TEST CASE #8. BRINE PRODUCTION RATE FOR PRESSURE-SPECIFIED DELIVERABILITY .....	70
FIGURE 9.8.3 RESULTS FROM TOUGH28W RUN ON TEST CASE #8. GAS PRODUCTION RATE FOR PRESSURE-SPECIFIED DELIVERABILITY .....	71
FIGURE 9.9.1 STEADY-STATE SOLUTION FOR TEST CASE #9, HOMOGENEOUS RESERVOIR CONDITIONS .....	75
FIGURE 9.9.2 STEADY-STATE SOLUTION FOR TEST CASE #9, HETEROGENEOUS RESERVOIR CONDITIONS .....	76
FIGURE 9.10.1 ANALYTICAL SOLUTION FOR TEST CASE #10: PRESSURE DRAWDOWN AT SEMI-STEADY STATE TIME, $T = 105$ s. ....	80
FIGURE 9.14.1 REPRESENTATION OF GRID USED FOR TEST CASE #14. ....	89

## LIST OF TABLES

TABLE 9.1 REQUIREMENT COVERAGE BY TEST CASE .....	18
TABLE 9.1.1 ANALYTICAL SOLUTION FOR TEST CASE #1. FROM BF2_TEST1_RAD.DAT .....	23
TABLE 9.1.2 ANALYTICAL SOLUTION FOR TEST CASE #1. FROM BF2_TEST1_TIME.DAT .....	24
TABLE 9.2.1 WATER SATURATION VALUES FOR ANALYTICAL SOLUTION TO TEST CASES #2 AND #3. ....	29
TABLE 9.2.2 WATER SATURATION VALUES FOR ANALYTICAL SOLUTION TO TEST CASES #2 AND #3. ....	30
TABLE 9.4.1 RESULTS FROM TOUGH RUN ON TEST CASE #4 BF2_TEST4_T019.DAT.....	38
TABLE 9.5.1 DATA FILES PRODUCED BY BF2_TEST5_BFDAT.FOR, TEST CASE #5 .....	40
TABLE 9.5.2 DATA FILES PRODUCED FOR TOUGH RESULTS TEST CASE #5 .....	40
TABLE 9.5.3 RESULTS FROM TOUGH RUN ON TEST CASE #5 BF2_TEST5_THHX.DAT .....	45
TABLE 9.6.1 GRID CELL NUMBERS USED IN BF2_QB0600_TEST6.CDB: FOR THE HUMAN INTRUSION BOREHOLE, AND MATERIALS IN THOSE CELLS PRIOR TO INTRUSION .....	59
TABLE 9.8.1 RESULTS FROM TOUGH28W RUN ON TEST CASE #8. BF2_TEST8_TOUGH.DAT.....	72
TABLE 9.9.1 ANALYTICAL STEADY-STATE SOLUTIONS FOR TEST CASE #9. HOMOGENEOUS RESERVOIR CONDITIONS .....	77
TABLE 9.10.1 ANALYTICAL SOLUTION FOR TEST CASE #10, FROM BF2_TEST10.DAT.....	81
TABLE 9.14.1 INITIAL CHEMICAL CONCENTRATIONS (KG/M <sup>3</sup> ) FOR WASTE AREAS IN TEST CASE #14. ....	89
TABLE 9.14.2 ADDITIONAL CHEMISTRY RATES TO BE TESTED IN TEST CASE #14.....	97
TABLE 9.14.3 TEST CASE #14 STOICHIOMETRIC COEFFICIENTS. ....	97



## ACRONYMS

BRAGFLO	BRine And Gas FLOW
CCA	Compliance Certification Application
CO <sub>2</sub>	Carbon dioxide
CRA	Compliance Recertification Application
CPR	Cellulose, Plastic and Rubber
DEC	Digital Electronic Corporation
DOE	U.S. Department of Energy
DRZ	Disturbed Rock Zone
EOS	Equation of State
Fe	Iron
Fe(OH) <sub>2</sub>	Iron hydroxide
FeS	Iron sulfide
H <sub>2</sub> S	Hydrogen sulfide
MgO	Magnesium oxide
PA	Performance Assessment
PREBRAG	Preprocessor for BRAGFLO
QA	Quality Assurance
RKS	Redlich-Kwong-Sauve
VMS	Virtual Memory System (a DEC operating system)
WIPP	Waste Isolation Pilot Plant

## 1.0 INTRODUCTION

The purpose of this document is to identify the requirements for the code BRAGFLO, Version 6.0, and to describe how the code is tested to ensure that those requirements are satisfied. BRAGFLO, Version 6.0, will replace previous BRAGFLO, Version, 5.0 (1,2). Revisions to BRAGFLO 5.0 resulting in version 6.0 are specified in a Change Control Form (3). They are needed to allow BRAGFLO to model additional Fe and MgO chemistry, as well as include the flexibility for different amounts of CPR, Fe and MgO in each panel. The code requirements documentation along with the verification and validation plan for the code are in accordance with the Nuclear Waste Management Procedure NP 19-1 (4).

### 1.1 Software Identifier

Code Name: BRAGFLO  
WIPP Prefix: BF2  
Version: 6.0  
Platform: Compaq FORTRAN 7.5 for OpenVMS AXP, version 8.2, on DEC Alpha.  
The previous version of BRAGFLO was Version 5.0, dated 01/22/03.  
The previous version of the RD/VVP was Version 5.02, ERMS# 536044, dated 7/16/04.

### 1.2 Points of Contact

The purpose of this document is to identify the requirements of the code BRAGFLO, Version 6.0, and to describe how the code is tested to ensure that those requirements are satisfied.

Sponsor: Martin Nemer  
Sandia National Laboratories Carlsbad Office  
4100 National Parks Highway  
Carlsbad, NM. 88220  
(505) 234-0005

Consultant: Daniel Clayton  
Sandia National Laboratories Carlsbad Office  
4100 National Parks Highway  
Carlsbad, NM. 88220  
(505) 234-0031

### 1.3 Description

BRAGFLO is a program used to study two-phase (brine and gas), three-dimensional isothermal flow in porous media. It is used for assessing the performance of the WIPP, particularly the flow behavior in the immediate vicinity of the repository. The physical model is described by material

balance equations for brine and gas, Darcy's law, and two phase fluid properties. The numerical model includes a cell-centered finite difference discretization, Newton solution of the nonlinear constitutive equations, and linear equation solvers necessary for the Newton iteration. Various submodels specific to WIPP include a pressure-induced fracture treatment, creep closure of the repository, and gas generation resulting from corrosion and biodegradation of waste components.

#### **1.4 Changes Required for BRAGFLO 6.0 From 5.0**

The primary purpose for revision of BRAGFLO 5.0 is to incorporate Fe and MgO chemistry into the model. The additional chemistry is added to improve the water balance equations. In version 5.0, brine reacts with Fe to generate  $\text{Fe}(\text{OH})_2$ , which consumes two water molecules for every Fe molecule. For version 6.0, an additional chemistry step of  $\text{Fe}(\text{OH})_2$  reacting with  $\text{H}_2\text{S}$  to generate FeS and two water molecules is added, where the  $\text{H}_2\text{S}$  is generated by the microbial degradation of the CPR material. Furthermore, the hydration and carbonation steps of MgO are added to the chemical system. When MgO hydrates, one molecule of water is consumed, and when the hydrated MgO reacts with the  $\text{CO}_2$  generated by the microbial degradation of the CPR material, one molecule of water is generated. These reactions are included to improve the calculation of saturation in the waste area.

Furthermore, several other models are included into BRAGFLO 6.0 to allow more flexibility. A model which can smoothly change the permeability of a material as a function of time is incorporated. Two new relative permeability and capillary pressure models are added. For materials in closure regions, a second porosity versus permeability model is employed. Finally, a subroutine to calculate the amount of solids generated from the chemistry reactions is implemented.

## **2.0 REQUIREMENTS**

### **2.1 Functional Requirements**

The functional requirements for BRAGFLO version 6.0 include all of those specified for BRAGFLO version 5.0 (1), as well as a few additional requirements, which are defined in this Section 2.0 of this document. The requirements for version 5.0 are listed in R.1 through R.19 below (1). The additional requirements are identified in R.20 and R.24.

- R.1 Input defining the problem to be run is read in, including mesh size, simulation time specifications, and output files to be used.
- R.2 The time and/or frequency of output to each output file and the variables whose values will be output are specified in the input.
- R.3 The code reads input defining the finite difference grid for the problem to be run, including values of  $\Delta x$ ,  $\Delta y$ , and  $\Delta z$ , and elevations of grid block centers, or input

parameters that allow BRAGFLO to calculate the elevations. These input parameters may also specify how the mesh is rotated or dipped relative to a reference right hand coordinate system.

- R.4 The default boundary conditions are no-flow conditions. BRAGFLO also allows constant pressure (Dirichlet) boundary conditions to be applied at specified grid blocks. The Dirichlet conditions fix the brine pressure and gas saturation at their initial values.
- R.5 The following initial conditions are specified on input at each grid block: brine pressure, brine saturation, iron concentration, the concentration of biodegradables and (NEW for BRAGFLO 6.0) the MgO concentration.
- R.6 Parameters are inputs that control the numerical behavior of BRAGFLO. These include specifications of convergence tolerances, iteration limits, upstream weighting control parameters, dependent variable increments used to calculate Jacobian element derivatives numerically, and the solver to be used. Two solvers are currently available, the original LU decomposition solver and the point successive over-relaxation (SOR) solver, and only the original LU decomposition solver will be used in WIPP CRA calculations.
- R.7 Material maps at specified times are input. For each material, material properties are input, including two-phase flow parameters, intrinsic permeability's, reference condition porosities, and compressibility's. Also specified are the relative permeability and capillary pressure model to be used for each material. (NEW for BRAGFLO 6.0) Furthermore, BRAGFLO allows for the change of pressure and saturation values, as well as the capability to turn off the chemistry reactions when materials change as specified by the .INP input file.
- R.8 Relative permeability's and capillary pressure are calculated for each material using one of several available models. The compliance calculations will use either a modified Brooks-Corey model or a van Genuchten/Parker model. Some of the QA tests use relative permeability models that are included in BRAGFLO specifically for those tests.
- R.9 A simplified rock fracture model allows the porosity and permeability to increase as pore pressure increases above a threshold value, simulating a fracture network. In the absence of fracturing, the porosity may vary slightly with pressure due to rock compressibility effects.
- R.10 The Klinkenberg effect is included, allowing the gas-phase permeability to become elevated over the intrinsic brine-phase permeability at low pressures in low-permeability materials.

- R.11 Brine salinity, density at reference conditions, and compressibility are specified by input values, and the density of brine varies as a function of pressure.
- R.12 Gas properties are given by the Redlich-Kwong-Soave (RKS) equation of state. The WIPP compliance calculations will use a single pure gas, H<sub>2</sub>.
- R.13 Two chemical reactions are modeled in BRAGFLO: anoxic corrosion of iron and microbial degradation of cellulose. Both of these reactions produce gas (H<sub>2</sub>) and consume brine according to specified stoichiometry. Reaction rates and stoichiometry are specified for brine-inundated conditions and for humid conditions. BRAGFLO reads the necessary parameters from the .INP input file.
- R.14 The effects of salt creep, whereby the surrounding halite closes in on the waste or other excavated regions, compressing them, may be simulated in BRAGFLO. Using this model, the porosity of the waste changes with time and brine pressure. The input file, containing the closure surface data (.CSD), is an ASCII input file that is read by BRAGFLO if creep closure is to be simulated as specified by a parameter in the ASCII input file (.INP). If creep closure is not to be simulated a dummy file must be included even though this dummy file will not be read. The information in the .CSD file, that is used in the validation of BRAGFLO 6.0, will be the same information that was incorporated into the BRAGFLO 4.10 executable file. BRAGFLO 6.0 reads the necessary information from the .INP and .CSD input files.
- R.15 BRAGFLO numerically calculates the flow of two phases, brine and gas, in porous media as a function of time and space, using an implicit finite difference method with variable time step control.
- R.16 Well models in BRAGFLO allow simulation of wells that are completed within the formations or porous media being modeled. The types of wells that can be modeled are constant injection or production rate wells and constant down-hole pressure wells. Well data is specified in the input control file.
- R.17 BRAGFLO simulates flow through heterogeneous as well as homogeneous porous media.
- R.18 BRAGFLO writes binary and ASCII output files. These files regurgitate much of the input file information as well as primary and secondary dependent variables at user specified frequencies or at specific times. Many output variables are user selected and defined.
- R.19 BRAGFLO provides the user with an error check on the consistency with how waste regions are specified.

- R.20 Five additional chemical reactions are modeled in BRAGFLO: sulfidation of iron hydroxide; sulfidation of iron; hydration of MgO, carbonation of MgO; and carbonation of Mg(OH)<sub>2</sub>. Stoichiometry is specified for each reaction. BRAGFLO reads the necessary parameters from the .INP input file.
- R.21 Chemical rates of all reactions are zero below a specified cutoff value in saturation, which is set in the .INP input file.
- R.22 Chemical rates of all reactions are multiplied by their respective initial concentrations if specified by a flag in the .INP input file.
- R.23 BRAGFLO calculates the change in solid volume from the chemical reactions.
- R.24 BRAGFLO allows for the smooth change in permeability of materials in time as specified by the .INP input file.

## 2.2 Performance Requirements

There are no performance requirements for BRAGFLO.

## 2.3 Attribute Requirements

There are no attribute requirements for BRAGFLO.

## 2.4 External Interface Requirements

The external interface requirements for version 6.0, which are the same as those for version 5.0 (1) are listed in R.25 to R.27 below.

- R.25 Software: For input, this code reads the output file generated by the code PREBRAG.
- R.26 Software: For input, BRAGFLO reads an external file that contains the creep closure look-up table data.
- R.27 Software: The output of this code is read as input by the code POSTBRAG.

## 2.5 Other Requirements

There are no other requirements for BRAGFLO that need verification.

## 3.0 DESIGN OVERVIEW

### 3.1 I/O Description

The files associated with BRAGFLO are described below:

#### Input Files

BRAGFLO reads as input an ASCII input file, **BF2\_xxx.INP**. This input file is the BRAGFLO input control file.

BRAGFLO reads as input an ASCII input file, **BF2\_xxx.CSD**. This input file is the file containing the creep closure look-up table data, which included the time dependent repository porosity.

In addition, the restart capability requires a binary restart input file (**BF2\_xxx.RIN**) to be read; however, **THIS CAPABILITY WILL NOT BE USED FOR WIPP COMPLIANCE CALCULATIONS AND WILL NOT BE TESTED AT THIS TIME.**

### Output Files

BRAGFLO writes one to four output files, the number and type of output file being at the user's discretion:

- 1) **BF2\_xxx.OUT**: ASCII output file, containing an extended echo of the input as well as results in the form of global variables and element variables (see the BRAGFLO User's Manual (2), for definitions of these terms). History variables are not written to this file. This file can be read as input by the postprocessing code POSTBRAG. Although useful during debugging and testing, this file will probably not be written in the WIPP compliance calculations.
- 2) **BF2\_xxx.SUM**: ASCII summary file, containing a very brief summary of results at each time step of a run. This file is usually written in order to monitor the progress of a run, but is usually discarded after the run is completed.
- 3) **BF2\_xxx.BIN**: Binary output file. This is the primary output file to which results are written. It includes QA information, grid descriptions, and global, element, and history variables. This file is read as input by the postprocessing code POSTBRAG.
- 4) **BF2\_xxx.ROT**: Restart output file, containing sufficient information to enable a run to be restarted at specified times. **THIS CAPABILITY WILL NOT BE USED FOR WIPP COMPLIANCE CALCULATIONS AND WILL NOT BE TESTED AT THIS TIME.**

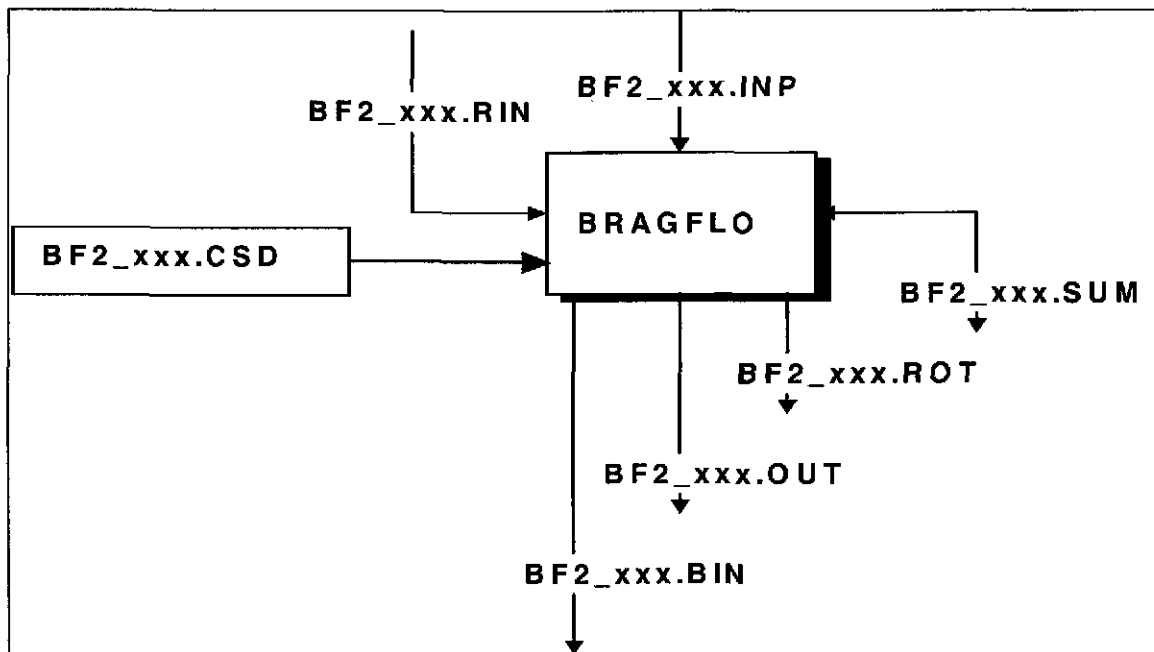
## 3.2 Context Diagram

The data flow for BRAGFLO is presented using a context diagram in Figure 3.1.

## 3.3 Design Constraints

BRAGFLO has already been developed; therefore, there are no design constraints.

**FIGURE 3.1 DATA FLOW FOR BRAGFLO**



#### **4.0 ADDITIONAL FUNCTIONALITY TO BE TESTED**

For BRAGFLO Version 6.0, no additional features will be tested.

#### **5.0 FUNCTIONALITY NOT TESTED**

For BRAGFLO Version 6.0, the following features are not tested at this time because they will not be used as part of the WIPP compliance calculations:

- 1) Radionuclide transport. BRAGFLO is no longer used for transport calculations because a faster, more accurate, and more versatile code, NUTS, is now available.
- 2) Gas dissolution. Dissolution of gas in brine may be simulated using either Henry's law for a single gas or bubble point tracking. The brine may be specified as initially gas-free or fully gas-saturated. This feature will not be used in the WIPP compliance calculations and is not tested.
- 3) Numerous options are available for inputting the description of the mesh. Because only a couple of these are regularly used, the only ones that are tested now are those that are used in the WIPP compliance calculations and in test cases for testing other features.
- 4) Reaction path gas generation model. This model has been neither fully developed nor implemented and is not available for the WIPP compliance calculations.



- 5) Multicomponent gas transport. Without a source of multiple gas components (i.e., the reaction path model), there is little point in tracking multiple gas components; this will not be done in the WIPP compliance calculations.
- 6) Three-dimensional calculations. Although BRAGFLO is a fully 3-D code, time and resource constraints currently preclude doing any 3-D calculations for WIPP compliance.
- 7) Four creep closure surfaces, that used to be included in the executable file for BRAGFLO 4.10, are now included in the input file, BF2\_CLOSURE.DAT, which is used for validating BRAGFLO 6.0. Only the most recent creep closure surface, number 4, (which became available in January 1996) is used for WIPP compliance calculations. The three earlier surfaces will not be considered.
- 8) Alternative equation solvers. In addition to the original LU solver, BRAGFLO also has a Linpack LU solver and a point-SOR iterative solver. The Linpack LU solver offers no advantages over the original LU solver, except for certain debugging capabilities. Because it has been coded very inefficiently, nearly doubling the memory required by BRAGFLO when it is used, it has been disabled in versions 4.10, 5.00 and 6.0. No iterative solver has yet been found that is sufficiently robust for calculations done for WIPP PA; in particular, the point-SOR solver is inadequate for use in the compliance calculations. An iterative multigrid solver is under development, but is not yet available for testing.
- 9) Capillary pressure treatment. An option in BRAGFLO is to allow the maximum capillary pressure to vary automatically. This model is experimental, has not been well-tested, and will not be used in the WIPP compliance calculations.
- 10) Numerical control parameters. The experience gained over several years of using BRAGFLO (5,6) has shown what values of the various control parameters will enable BRAGFLO to run successfully. Test cases show that these values are being used as intended in the code. However, because the values of these parameters will not be varied in the WIPP compliance calculations, further testing is not done.
- 11) Multicomponent gas properties. BRAGFLO is capable of calculating gas properties using either the ideal gas law or the Redlich-Kwong-Soave equation of state. Properties can be calculated for either pure gases or for mixtures of any of the following six gases: H<sub>2</sub>, CO<sub>2</sub>, CH<sub>4</sub>, N<sub>2</sub>, O<sub>2</sub>, and H<sub>2</sub>S. Because the WIPP compliance calculations use pure hydrogen and the Redlich-Kwong-Soave equation of state, the calculation of mixture properties and use of the ideal gas law are not tested.
- 12) Restart capability. This feature is used only for debugging and will not be used for the WIPP compliance calculations.
- 13) Relative permeability and capillary pressure models. BRAGFLO currently has 12 relative permeability and capillary pressure models available. Only four of these are

expected to be used for the WIPP compliance calculations, KRP = 1, 4, 11 and 12; these will be tested for software QA. Three others (KRP = 5, 9, and 10) are used in QA testing, so these will also be tested. None of the other five models will be tested at this time.

- 14) Radiolysis (the radiolytic breakdown of water into hydrogen and oxygen) may be calculated. The initial inventory of radionuclides in the waste is input, and BRAGFLO calculates the decay of this inventory over time, along with the amount of water that is decomposed and the amount of gas generated. This feature will not be used in the WIPP compliance calculations and will not be tested now.
- 15) Certain little-used options for inputting the mesh are not tested. For parameter IDZFLAG, which specifies how  $\Delta z$  is input, options 2, 3, and 4 are not tested. (IDZFLAG options that are tested include 0 and 1.) For parameter IDEPTHFLAG, which specifies how the grid block elevations are input, options 1, 2, 3, 4, 5, 6, and -1 are not tested. (IDEPTHFLAG options that are tested include 0, -2, -3, and 7.) All available options for parameters IDXFLAG and IDYFLAG, which specify how  $\Delta x$  and  $\Delta y$  are input, are tested.
- 16) Permeability versus porosity models for closure materials. Currently there are two models which are included, but are not used in the WIPP compliance calculations and will not be tested.

## 6.0 TESTING ENVIRONMENT

BRAGFLO, Version 6.0, will be tested in the following environment:

Hardware Platform: DEC Alpha  
Operating System: OpenVMS AXP, version 8.2, on a DEC Alpha  
Program Language: Compaq FORTRAN 7.5 for OpenVMS AXP 8.2

## 7.0 STATIC TESTING

Static testing is performed using the source code analyzer DECset-SCA. DECset-SCA is used to identify unreachable coding and to create a subroutine call-tree. The SCA tests are run automatically when the Software Configuration Management System (SCMS) Librarian generates the production executable for BRAGFLO; this process will be described in more detail in the *Implementation Document for BRAGFLO Version 6.0 (7)*.

The code sponsor should examine the SCA output. Unreachable coding will either be changed so that it is reachable, or justified as not being relevant to the performance of the software as it relates to WIPP PA.

## 8.0 COVERAGE TESTING

Coverage testing is performed using the performance coverage analyzer DECset-PCA. DECset-PCA is used to identify modules that are not exercised by the test set. A unique executable will be described in the *Implementation Document for BRAGFLO Version 6.0, (7)*.

The code sponsor should examine the PCA output. Unexercised modules must be justified as not being relevant to the performance of the software as it relates to WIPP PA.

## 9.0 FUNCTIONAL TESTING

Validation of BRAGFLO 6.0 uses the same 13 test cases that were used in the validation of BRAGFLO 5.0 (8), with an additional test case. The parameters used in the first 13 test cases are the same parameters that were used for the validation of BRAGFLO 5.0 (8). The following test cases have been designed to ensure that the software adequately performs all intended functions and produces valid results. Table 9-1 displays the list of requirements and the test cases that verify those requirements. The results of the performance verification and validation tests as given in this plan and the comparison of test case input and output, along with the evaluation of test results versus the acceptance criteria, will be documented in the Validation Document.

**TABLE 9.1 REQUIREMENT COVERAGE BY TEST CASE**

Requirement Type	Req. #	Test Case Number													
		1	2	3	4	5	6	7	8	9	10	11	12	13	14
Functional	R.1	X	X		X	X	X	X							
	R.2	X	X		X	X	X	X					X		
	R.3	X	X		X	X	X	X							
	R.4			X				X			X				
	R.5	X	X		X	X	X	X							X
	R.6	X	X		X	X	X	X							
	R.7	X	X		X	X	X	X							X
	R.8		X		X		X	X							X
	R.9						X	X							
	R.10						X	X							
	R.11	X	X		X	X	X	X							
	R.12		X		X	X	X	X							
	R.13						X	X							
	R.14						X	X							
	R.15	X	X		X	X	X	X				X			
	R.16				X	X			X						
	R.17									X					
	R.18	X	X	X	X	X	X	X	X	X	X	X	X		X
	R.19													X	
	R.20														X
	R.21														X
	R.22														X
	R.23														X
	R.24														X
External Interface	R.25						X	X							
	R.26						X	X							
	R.27						X	X							

## 9.1 Test Case #1. Pressure drawdown with radial grid.

### 9.1.1 Test Objective

The purpose of this test is to verify that BRAGFLO can accurately calculate transient fluid pressures using a Cartesian representation of a radial grid by comparing BRAGFLO results with an analytical solution. This is a test of Functional Requirement R.15, for a single phase. This is a very basic simulation of pressure drawdown in a radially symmetric reservoir as brine is injected into the center. The radially symmetric grid is represented by a one-dimensional Cartesian grid in which the Cartesian grid blocks preserve the volume of the corresponding radial grid blocks. The analytical solution to this problem is (9):

$$p(r,t) = p_o + \frac{Q\mu}{4\pi kh} \left[ -Ei\left(-\frac{\phi\mu c_b r^2}{4kt}\right) + Ei\left(-\frac{\phi\mu c_b r^2}{4k(t-t_s)}\right) \right]. \quad 9.1.1$$

where

- $p$  = brine pressure [Pa],
- $p_o$  = initial brine pressure,  $1.0 \times 10^7$  Pa,
- $Q$  = brine injection rate,  $-0.01 \text{ m}^3/\text{s}$ ,
- $\mu$  = brine viscosity,  $0.0018 \text{ Pa s}$ ,
- $k$  = permeability,  $1.8 \times 10^{-11} \text{ m}^2$ ,
- $h$  = thickness of formation,  $1.0 \text{ m}$ ,
- $\phi$  = porosity,  $0.1 \text{ m}^3 \text{ void}/\text{m}^3 \text{ rock}$ ,
- $c_b$  = brine compressibility,  $2.5 \cdot 10^{-10} \text{ Pa}^{-1}$ ,
- $r$  = radial distance from center [m],
- $t$  = time [s],
- $t_s$  = shut-in time,  $5000 \text{ s}$ ,
- $Ei$  = exponential integral.

Plots of the analytical solution are shown in Figures 9.1.1 and 9.1.2. Numerical values for the analytical solution are shown in Tables 9.1.1 and 9.1.2.

In addition, this test case tests the basic Functional Requirements R.1 to R.3, R.5 to R.7, R.11, and R.18, which describe the problem being tested. Functional Requirement R.16, the well models, is exercised, but is not examined explicitly in this test case. Functional Requirement R.15, flow calculations for two phases in a porous medium, is also implicitly tested.

### 9.1.2 Test Procedure

The BRAGFLO validation tests are run using the WIPP PA run control system. The scripts and script input files that run the validation tests are stored in CMS. All test inputs are fetched at run time by the scripts. All test outputs/results and run logs are stored in CMS by the scripts in class QB0600 of the CMS library, WP\$CMSROOT:[BF]. Other files related to the validation of

BRAGFLO 6.0 are submitted for storage in CMS by the SCMS Librarian and reside in QB0600 class of the CMS library.

The Fortran code, BF2\_TEST1\_POST.FOR, was used in the validation of BRAGFLO 4.10. It may need to be modified to accommodate additional information in the ASCII output file, BF2\_QB0600\_TEST1.OUT from BRAGFLO 6.0, but all files and code used in the validation will be stored in CMS class QB0600. The executable file of the Fortran code is run to perform several post-processing functions: 1) It extracts results from the BRAGFLO ASCII output file, BF2\_QB0600\_TEST1.OUT; 2) it calculates the analytical solution at the same times at which BRAGFLO has output results; 3) it calculates the absolute and relative errors in the BRAGFLO results compared with the analytical results; and 4) it places the results for both BRAGFLO and the analytical solution into two data files, BF2\_TEST1\_RAD.DAT and BF2\_TEST1\_TIME.DAT. These two files are then read by the plotting software, SPLAT, which creates plots reproducing Figures 9.1.1 and 9.1.2 with BRAGFLO results superimposed. Results for the analytical solutions at times at which BRAGFLO should produce results are shown in Tables 9.1.1 and 9.1.2.

### 9.1.3 Input Files

The BRAGFLO input files for Test Case #1 are called BF2\_QB0600\_TEST1.INP and BF2\_CLOSURE.DAT. Additional parameters have been added to the input file to suppress the new models added to BRAGFLO 6.0 compared with BRAGFLO 5.0. Otherwise, the input file, BF2\_QB0600\_TEST1.INP, is identical to BF2\_QA0500\_TEST1.INP, which is the input file for Test Case #1 in the validation of BRAGFLO 5.0.

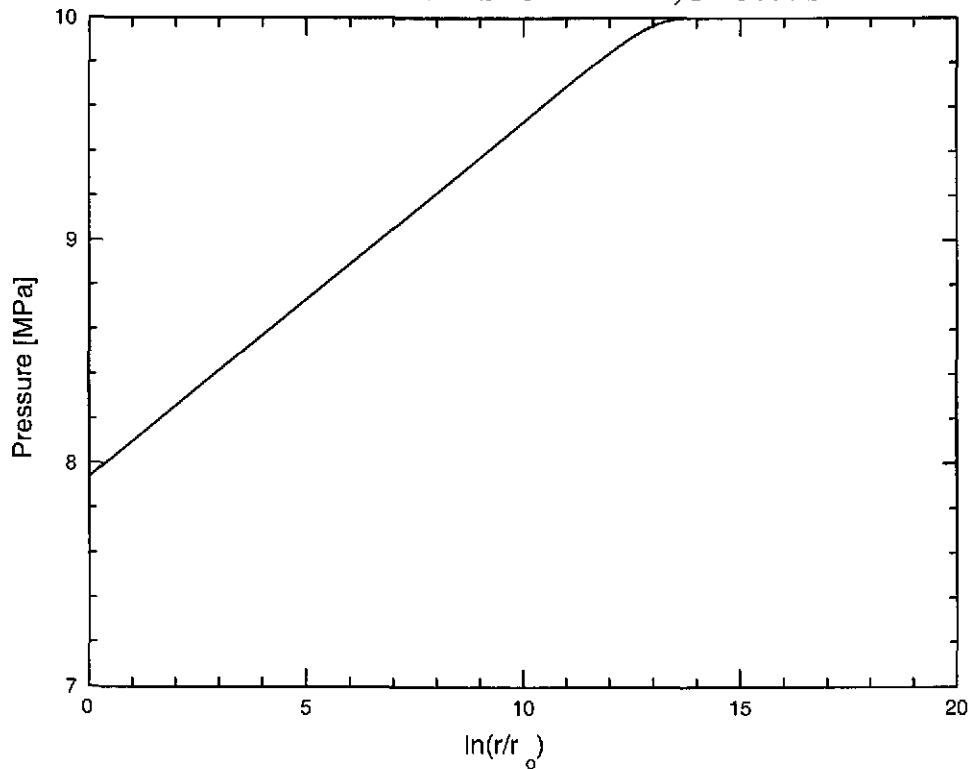
### 9.1.4 Acceptance Criteria

The acceptance criteria for Test Case #1 are comparisons with confirmed published data and technical literature together with manual inspection of the output from the test case.

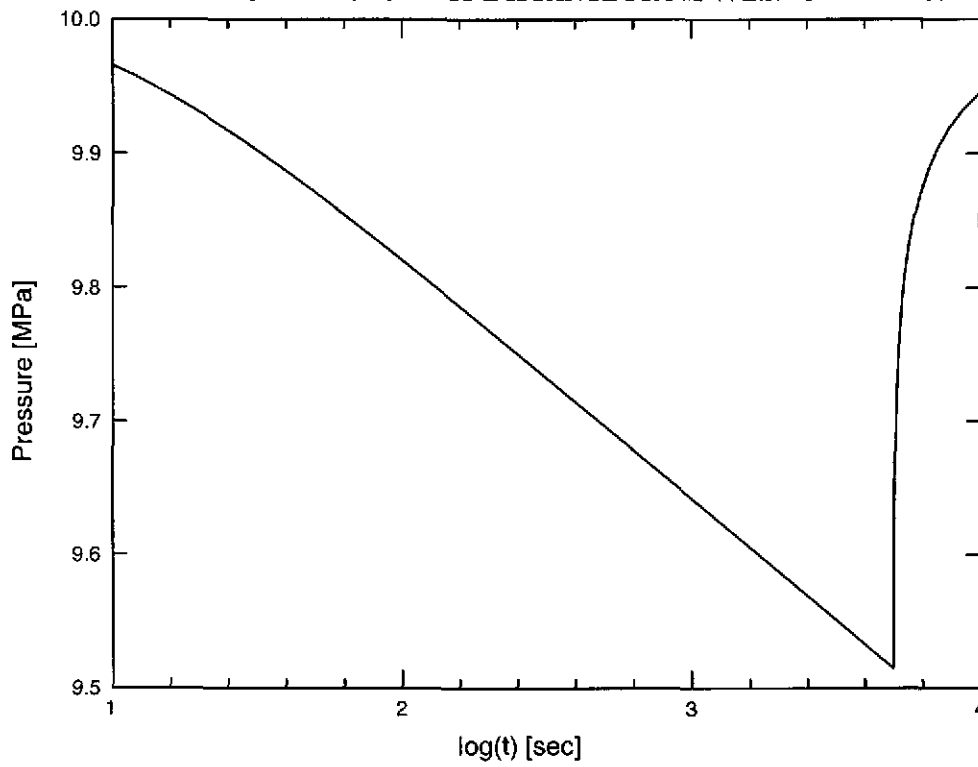
Results from Test Case #1 should agree within 10% relative error with the analytical solution. The closeness with which the BRAGFLO results agree with the analytical solution depends on the mesh size, the time step sizes, and the convergence tolerances specified by the user. Exact agreement is not expected because of the discretization errors and round-off inherent in any numerical solution of a system of differential equations. It is up to the analyst to determine how accurate the solution must be for the intended purpose of the calculation and how to achieve that degree of accuracy using BRAGFLO. The BRAGFLO results should, however, show the same trends as the analytical solution. In a plot of pressure vs. distance from the well, at the shut-in time  $t = 5000$  s, the pressure at the well [ $\ln(r/r_o) = 0.0$ ] should be low, and the pressure should increase monotonically away from the well. The increase should be approximately linear near the well, then approach the initial formation pressure of 10 MPa asymptotically. In a plot of pressure vs. time at a specific distance from the well, the pressure should decrease monotonically from the initial well pressure until the shut-in time is reached. Then the pressure should build up again, rapidly at first. This will verify Functional Requirement R.15 for a single phase.

Visual inspection of the ASCII output file should confirm that the input that describes the test case has been read in correctly. Output values should agree with values in the input file to the least number of significant figures that are reported in either file, verifying Functional Requirements R.1 to R.3, R.5 to R.7, R.11, R.15, and R.18. The close agreement between BRAGFLO results and the analytical solution should further validate these Functional Requirements by showing that the description of the test case has been properly treated numerically.

**FIGURE 9.1.1 ANALYTICAL SOLUTION FOR TEST CASE #1: PRESSURE  
DRAWDOWN AT SHUT-IN TIME,  $T = 5000$  S**



**FIGURE 9.1.2 ANALYTICAL SOLUTION FOR TEST CASE #1: PRESSURE  
DRAWDOWN HISTORY AT DISTANCE FROM WELL OF R = 100.4 M**



U1(JDSCHRE.BRAGFLO.OA\_95.S\_04)BF2\_TEST1\_FIG2.CMD;1

SPLAT X2.0 09/27/95 11:15:05

Information Only



**TABLE 9.1.1 ANALYTICAL SOLUTION FOR TEST CASE #1. FROM  
 BF2\_TEST1\_RAD.DAT**

$\ln(r/r_0)$	$P, \text{ MPa}$
0.000000	7.937800
1.193922	8.127819
1.838961	8.230480
2.320130	8.307060
2.723274	8.371222
3.081870	8.428295
3.412430	8.480905
3.724259	8.530534
4.023076	8.578092
4.312603	8.624172
4.595371	8.669176
4.873151	8.713386
5.147215	8.757005
5.418486	8.800179
5.687649	8.843017
5.955211	8.885601
6.221555	8.927991
6.486971	8.970233
6.751675	9.012362
7.015836	9.054405
7.279581	9.096381
7.543005	9.138305
7.806184	9.180191
8.069174	9.222046
8.332020	9.263878
8.594754	9.305690
8.857403	9.347487
9.119987	9.389270
9.382519	9.431039
9.645013	9.472792
9.907477	9.514524
10.16992	9.556223
10.43234	9.597872
10.69475	9.639439
10.95715	9.680868
11.21954	9.722068
11.48193	9.762885
11.74431	9.803062
12.00668	9.842184
12.26906	9.879586
12.53143	9.914255
12.79380	9.944761
13.05617	9.969357
13.31853	9.986492
13.58090	9.995856
13.84327	9.999292
14.10563	9.999954
14.36800	9.999999
14.63036	10.000000
14.89273	10.000000

**TABLE 9.1.2 ANALYTICAL SOLUTION FOR TEST CASE #1. FROM  
 BF2\_TEST1\_TIME.DAT**

<b>log(t [s])</b>	<b>P, MPa</b>
1.000000	9.965941
1.518511	9.899661
1.698097	9.871513
1.856544	9.845393
2.001864	9.820676
2.138489	9.796954
2.269108	9.773948
2.395457	9.751467
2.518707	9.729377
2.639676	9.707577
2.758948	9.685997
2.876946	9.664582
2.993983	9.643294
3.110291	9.622101
3.226044	9.600982
3.341375	9.579919
3.456383	9.558899
3.571143	9.537911
3.685714	9.516949
3.698970	9.514524
3.699838	9.548423
3.700704	9.583422
3.701827	9.614340
3.703283	9.642222
3.705168	9.667996
3.707607	9.692266
3.710757	9.715413
3.714818	9.737676
3.720041	9.759200
3.726739	9.780065
3.735295	9.800299
3.746171	9.819888
3.759914	9.838787
3.777154	9.856920
3.798589	9.874189
3.824961	9.890481
3.857013	9.905676
3.895429	9.919663
3.940773	9.932348
3.993422	9.943670
4.000000	9.944891

## 9.2 Test Case #2. Horizontal one-dimensional infiltration.

### 9.2.1 Test Objective

The purpose of this test is to verify that BRAGFLO can accurately track a propagating wetting profile in a horizontal, partially saturated, one-dimensional system.

In this problem, a semi-infinite horizontal tube of porous material is partially saturated with water. At time zero, the left end of the tube is wetted, raising the water content to full saturation; the saturation is held constant thereafter at fully saturated condition. The flow of water along the tube is to be calculated. This tests the fundamental Functional Requirement R.15, the calculation of multiphase flow in a porous medium.

Test Case #2 has a semi-analytical solution originally solved by Philip (10) and described by Ross et al. (11). The solution was featured as Sample Problem No. 2 in the TOUGH User's Guide (12). It has been further described by Updegraff (13) and by Moridis and Pruess (14). The semi-analytical solution is shown in Figure 9.2.1, in which water saturation profiles along the tube are shown at different times.

This test case uses linear relative permeability and capillary models:

$$k_{rw} = \begin{cases} 0, & S_w \leq S_{wr} \\ \frac{S_w - S_{wr}}{1 - S_{wr} - S_{nwr}}, & S_{wr} < S_w < 1 - S_{nwr} \\ 1, & S_w \geq 1 - S_{nwr} \end{cases} \quad (9.2.1)$$

$$k_{rnw} = 1 - k_{rw} \quad (9.2.2)$$

$$P_c = \begin{cases} P_{c,max}, & S_w \leq S_{wr} \\ \left( P_{ct} - P_{c,max} \right) \frac{S_w - S_{wr}}{1 - S_{wr} - S_{nwr}} + P_{c,max}, & S_{wr} < S_w < 1 - S_{nwr} \\ P_{ct}, & S_w \geq 1 - S_{nwr} \end{cases} \quad (9.2.3)$$

where

- $k_{rw}$  = brine relative permeability,
- $k_{rnw}$  = gas relative permeability,
- $S_w$  = wetting phase (brine) saturation,
- $S_{wr}$  = brine residual saturation = 0.3333333,
- $S_{nwr}$  = nonwetting phase (gas) residual saturation = 0.0,
- $P_c$  = capillary pressure [Pa],
- $P_{c,max}$  = maximum capillary pressure [Pa] = 9807.0 Pa
- $P_{ct}$  = threshold capillary pressure [Pa] = 0.0 Pa.

In addition, this test case tests the basic Functional Requirements R.1 to R.3, R.5 to R.8, and R18, which describe the problem being tested, and R.11 and R.12, the equations of state for fluids.

### 9.2.2 Test Procedure

The BRAGFLO validation tests are run using the WIPP PA run control system. The scripts and script input files that run the validation tests are stored in CMS. All test inputs are fetched at run time by the scripts. All test outputs/results and run logs are stored in CMS by the scripts in class QB0600 of the CMS library, WP\$CMSROOT:[BF]. Other files related to the validation of BRAGFLO 6.0 are submitted for storage in CMS by the SCMS Librarian and reside in QB0600 class of the CMS library.

The Fortran code, BF2\_TEST2\_BSAT.FOR, was used in the validation of BRAGFLO 4.10. It may need to be modified to accommodate additional information in the ASCII output file, BF2\_QB0600\_TEST2.OUT for BRAGFLO 6.0, but all files and code used in the validation will be stored in CMS class QB0600. The executable file of the Fortran code is run to extract results from the BRAGFLO ASCII output file, BF2\_QB0600\_TEST2.OUT and place them in three data files, BF2\_TEST2\_ASAT01.DAT, BF2\_TEST2\_ASAT06.DAT, and BF2\_TEST2\_ASAT11.DAT, which are input to the plotting software, SPLAT. SPLAT reproduces Figure 9.2.1 using values for the analytical solution and adds the BRAGFLO results.

### 9.2.3 Input Files

The BRAGFLO input files for Test Case #2 is called BF2\_QB0600\_TEST2.INP and BF2\_CLOSURE.DAT. Additional parameters have been added to the input file to suppress the new models added to BRAGFLO 6.0 compared with BRAGFLO 5.0. Otherwise, the input file, BF2\_QB0600\_TEST2.INP, is identical to BF2\_QA0500\_TEST2.INP, which is the input file for Test Case #2 in the validation of BRAGFLO 5.0.

### 9.2.4 Acceptance Criteria

The acceptance criteria for Test Case #2 are comparisons with confirmed published data and technical literature and independent calculations, together with manual inspection of the output from the test case.

Results from Test Case #2 should agree within 10% relative error with the analytical solution where it is given. Water saturation values for the analytical solution were obtained from Table 4.1 of Ross et al. (11), and are listed in Tables 9.2.1 and 9.2.2. The closeness with which the BRAGFLO results agree with the analytical solution depends on the mesh size, the time step sizes, and the convergence tolerances specified by the user. Exact agreement is not expected because both BRAGFLO and the analytical solution involve numerical solutions to differential equations, which are by nature approximations to the true solutions. It is up to the analyst to determine how accurate the solution must be for the intended purpose of the calculation and how

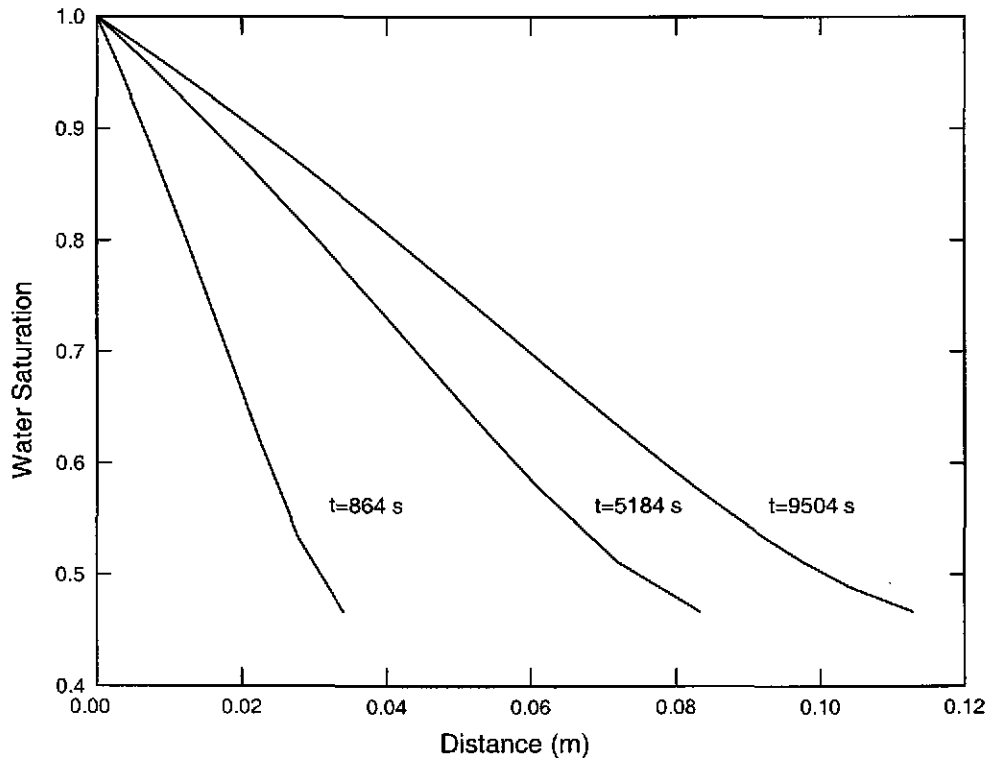
to achieve that degree of accuracy using BRAGFLO. The BRAGFLO results should, however, show the same trends as the analytical solution. The water saturation at the boundary should remain at 1.0, and at all times the water saturation should decrease monotonically with increasing distance from the left boundary. At later times, the water saturation should increase over the full length of the tube, although the increase may be negligible at the far end of the tube.

These results should validate Functional Requirement R.15.

Independent calculations should confirm that the relative permeability's are calculated correctly. Using values of brine saturation at any grid block reported in the output files, the values of relative permeability and capillary pressure obtained by independent calculation should agree to approximately three or four digits. These independent calculations should validate Functional Requirement R.8 using the relative permeability model specific to Test Case #2.

Visual inspection of the ASCII output file should confirm that the input that describes the test case has been read in correctly. Output values should agree with values in the input file, verifying Functional Requirements R.1 to R.3, R.5 to R.8, R.11, R.12, and R.18. The close agreement between BRAGFLO results and the analytical solution should further validate these Functional Requirements by showing that the description of the test case has been properly treated numerically.

**FIGURE 9.2.1 ANALYTICAL SOLUTION FOR TEST CASE #2: SATURATION PROFILES ALONG TUBE AT VARIOUS TIMES FOR ONE-DIMENSIONAL INFILTRATION PROBLEM**



U1:\JDSCHRE\BRAGFLO.QA\_95.1D\INFIL\BF2\_TEST2\_FIG1.CMD;1

SPLAT X2.0 09/27/95 11:19:42

**TABLE 9.2.1 WATER SATURATION VALUES FOR ANALYTICAL  
SOLUTION TO TEST CASES #2 AND #3.**  
Data from Table 4.1 of Ross *et al.* (9)  
(page 1 of 2)

BF2\_TEST2\_ASAT01.DAT (864 s)

BF2\_TEST3\_ASAT01.DAT (864 s)

Distance, m	$S_w$
0.00000	1.0000
0.00302	0.9556
0.00726	0.8889
0.01249	0.8000
0.01744	0.7111
0.02237	0.6222
0.02780	0.5333
0.03403	0.4667

BF2\_TEST2\_ASAT06.DAT (5184 s)

BF2\_TEST3\_ASAT06.DAT (5184 s)

Distance, m	$S_w$
0.00000	1.0000
0.00376	0.9778
0.00741	0.9556
0.01440	0.9111
0.02107	0.8667
0.03059	0.8000
0.03972	0.7333
0.04572	0.6889
0.05173	0.6444
0.05479	0.6222
0.06112	0.5778
0.07211	0.5111
0.08334	0.4667

**TABLE 9.2.2 WATER SATURATION VALUES FOR ANALYTICAL  
SOLUTION TO TEST CASES #2 AND #3.**  
Data from Table 4.1 of Ross *et al.* (9)  
(page 2 of 2)

BF2\_TEST2\_ASAT11.DAT (9504 s)

BF2\_TEST3\_ASAT11.DAT (9504 s)

Distance, m	$S_w$
0.00000	1.0000
0.00509	0.9778
0.01003	0.9556
0.01483	0.9333
0.01950	0.9111
0.02406	0.8889
0.02852	0.8667
0.03290	0.8444
0.03719	0.8222
0.04141	0.8000
0.04558	0.7778
0.04970	0.7556
0.05379	0.7333
0.05785	0.7111
0.06190	0.6889
0.06596	0.6667
0.07004	0.6444
0.07418	0.6222
0.07840	0.6000
0.08276	0.5778
0.08733	0.5556
0.09221	0.5333
0.09764	0.5111
0.10407	0.4889
0.11285	0.4667



### **9.3 Test Case #3. Horizontal 1 D infiltration, with Dirichlet boundary condition.**

#### **9.3.1 Test Objective**

This test is identical to Test Case #2 except that the Dirichlet boundary condition feature in BRAGFLO, Functional Requirement R.4, is applied. Only Functional Requirements R.4 and R.18 are tested, since other applicable requirements are tested in Test Case #2. In Test Case #2, the water saturation at the left boundary was not actually fixed, as the problem statement requires. Instead, the grid cell at the left boundary was made very large so that the pressure and water saturation in that cell do not change appreciably over the course of the run. This is an approximation that is satisfactory as long as the input is sized properly, both in the physical size of the mesh and in the simulated duration of the run. A more exact and rigorous approach is to apply a Dirichlet condition at the boundary. Using this feature in BRAGFLO, the pressure and water saturation at the left boundary can be fixed at exactly the value specified. The purpose of this test is to verify that BRAGFLO can hold the pressure and water saturation fixed, at values specified in the input, at specified grid cells, while continuing to track accurately a propagating wetting profile in a horizontal, partially saturated, one-dimensional system.

#### **9.3.2 Test Procedure**

The BRAGFLO validation tests are run using the WIPP PA run control system. The scripts and script input files that run the validation tests are stored in CMS. All test inputs are fetched at run time by the scripts. All test outputs/results and run logs are stored in CMS by the scripts in class QB0600 of the CMS library, WP\$CMSROOT:[BF]. Other files related to the validation of BRAGFLO 6.0 are submitted for storage in CMS by the SCMS Librarian and reside in QB0600 class of the CMS library.

The Fortran code, BF2\_TEST3\_BSAT.FOR, was used in the validation of BRAGFLO 4.10. It may need to be modified to accommodate additional information in the ASCII output file, BF2\_QB0600\_TEST3.OUT for BRAGFLO 6.0, but all files and code used in the validation will be stored in CMS class QB0600. The executable file of the Fortran code is run to extract results from the BRAGFLO ASCII output file, BF2\_QB0600\_TEST3.OUT and place them in three data files, BF2\_TEST3\_ASAT01.DAT, BF2\_TEST3\_ASAT06.DAT, and BF2\_TEST3\_ASAT11.DAT, which are input to the plotting software, SPLAT. The post-processing files are identical to those in Test Case #2, except that all file names are designated \*TEST3\* instead of \*TEST2\*. They may be viewed in Figures 9.2.1 and Tables 9.2.1 and 9.2.2

The results are plotted along with the analytical solution in the same manner as in Test Case #2. To provide a graphical display of the output, the code BF2\_TEST3\_BSAT.FOR, which will also be stored in CMS class QB0600, is run to extract results from the BRAGFLO ASCII output file, BF2\_QB0600\_TEST3.OUT, and place the results in a data file. The plotting software, SPLAT, using the plotting command file, BF2\_TEST3\_SPLAT.CMD reproduces Figure 9.2.1 using values for the analytical solution and adds the BRAGFLO results. The values used in plotting the analytical solution are in files BF2\_TEST3\_ASAT01.DAT,

BF2\_TEST3\_ASAT06.DAT, and BF2\_TEST3\_ASAT11.DAT, are shown in Figure 9.2.2. The post-processing files are identical to those in Test Case #2, except that all file names are designated \*TEST3\* instead of \*TEST2\*, so the file contents are not repeated here.

### 9.3.3 Input Files

The BRAGFLO input files for Test Case #3 are called BF2\_QB0600\_TEST3.INP and BF2\_CLOSURE.DAT. Additional parameters have been added to the input file to suppress the new models added to BRAGFLO 6.0 compared with BRAGFLO 5.0. Otherwise, the input file, BF2\_QB0600\_TEST3.INP, is identical to BF2\_QA0500\_TEST3.INP, which is the input file for Test Case #3 in the validation of BRAGFLO 5.0.

### 9.3.4 Acceptance Criteria

The acceptance criteria for Test Case #3 are comparisons with confirmed published data and technical literature together with manual inspection of the output from the test case. As in Test Case #2, BRAGFLO results should agree reasonably well with the analytical solution, showing similar trends. Again, the closeness with which the BRAGFLO results agree with the analytical solution depends on the mesh size, the time step sizes, and the convergence tolerances specified by the user. Exact agreement is not expected because both BRAGFLO and the analytical solution involve numerical solutions to differential equations, which are by nature approximations to the true solutions. It is up to the analyst to determine how accurate the solution must be for the intended purpose of the calculation and how to achieve that degree of accuracy using BRAGFLO. Unlike Test Case #2, however, the saturation and pressure at the left boundary should remain identical to the initial saturation and pressure, as specified in the input file, namely, a water saturation of 1.00000 and a pressure of  $1.09525 \times 10^5$  Pa. This will validate Functional Requirement R.4. In addition successfully writing the output files verified Functional Requirements R18.

## 9.4 Test Case #4. Two-dimensional infiltration.

### 9.4.1 Test Objective

The purpose of this test is to verify that BRAGFLO can accurately track a propagating wetting profile in a partially saturated, vertical, two-dimensional system. Results are compared both with TOUGH and with experimental measurements made by Vauclin et al. (15).

A vertical slab of soil has dimensions 3 m by 2 m. At the initial time, the water table is located 0.65 m from the bottom. In this saturated region, the water saturation is 1.0, and the water is in gravity equilibrium. Above the water table, the soil is unsaturated and in gravity/capillary equilibrium. The lower boundary and left boundary (line of symmetry) are impervious to flow. The right boundary is a mixed type, with the surface below the water table at a constant pressure and constant water saturation of 1. Above the water table, the right boundary is a seepage surface in which the water flux is zero when the surface is unsaturated and maintains a pressure equal to the hydraulic head when the surface is saturated. The seepage face across the top surface is simulated by a no-flow boundary, as discussed by Moridis and Pruess (14). Beginning at the initial time, infiltration is modeled by water injection along the first 0.5 m of the top surface at a fixed rate of  $4.111 \times 10^{-5}$  m/s. Figure 9.4.1 shows water content as a function of depth into the soil slab at various times after the start of recharge, and compares TOUGH simulation results with experimental results at a horizontal distance of 0.19 m from the line of symmetry. In Figure 9.4.2, TOUGH and experimental results are compared at a distance of 1.39 m from the line of symmetry.

Simulating the advance of the saturation front during the recharge of the system using BRAGFLO is a test of Functional Requirement R.15. Use of a well model to inject water is a test of Functional Requirement R.16.

The BRAGFLO and TOUGH solutions use a relative permeability and capillary pressure model specific to this test case based on experimental measurements and analyses done by Vauclin et al. (15). Their correlations for unsaturated hydraulic conductivity and moisture content as functions of capillary head have been converted to correlations for relative permeability and capillary pressure ( $P_c$ ) as follows:

$$S_e = \frac{1 - S_w}{S_w} \quad (9.4.1)$$

$$k_{rw} = \frac{1}{1 + 28.768353S_e^{1.7241379}} \quad (9.4.2)$$

$$k_{m_w} = 1 - k_{rw} \quad (9.4.3)$$

$$P_c = 3783.0145S_e^{(1/2.9)} \quad (9.4.4)$$

where

$S_w$  = wetting phase (brine) saturation,

$S_e$  = effective brine saturation,  
 $k_{rw}$  = brine relative permeability,  
 $k_{mw}$  = gas relative permeability,  
 $P_c$  = capillary pressure [Pa],

Although these models are not used in the compliance calculations, their use in this test case requires that they be tested to validate Functional Requirement R.8.

In addition, this test case tests the basic Functional Requirements R.1 to R.3, R.5 to R.7, and R.18, which describe the problem being tested, and R.11 to R.12, the equations of state for the fluids.

### 9.4.2 Test Procedure

The BRAGFLO validation tests are run using the WIPP PA run control system. The scripts and script input files that run the validation tests are stored in CMS. All test inputs are fetched at run time by the scripts. All test outputs/results and run logs are stored in CMS by the scripts in class QB0600 of the CMS library, WP\$CMSROOT:[BF]. Other files related to the validation of BRAGFLO 6.0 are submitted for storage in CMS by the SCMS Librarian and reside in QB0600 class of the CMS library.

The Fortran code, BF2\_TEST4\_BSAT.FOR, was used in the validation of BRAGFLO 4.10. It may need to be modified to accommodate additional information in the ASCII output file, BF2\_QB0600\_TEST4.OUT for BRAGFLO 6.0, but all files and code used in the validation will be stored in CMS class QB0600. The executable file of the Fortran code is run to extract results from the BRAGFLO ASCII output file, BF2\_QB0600\_TEST4.OUT and place them in a data file, which is input to the plotting software, SPLAT. SPLAT reproduces Figures 9.4.1 and 9.4.2, and the BRAGFLO results are superimposed for comparison.

### 9.4.3 Input Files

The BRAGFLO input files for Test Case #4 are called BF2\_QB0600\_TEST4.INP and BF2\_CLOSURE.DAT. Additional parameters have been added to the input file to suppress the new models added to BRAGFLO 6.0 compared with BRAGFLO 5.0. Otherwise, the input file, BF2\_QB0600\_TEST4.INP, is identical to BF2\_QA0500\_TEST4.INP, which is the input file for Test Case #4 in the validation of BRAGFLO 5.0.

### 9.4.4 Acceptance Criteria

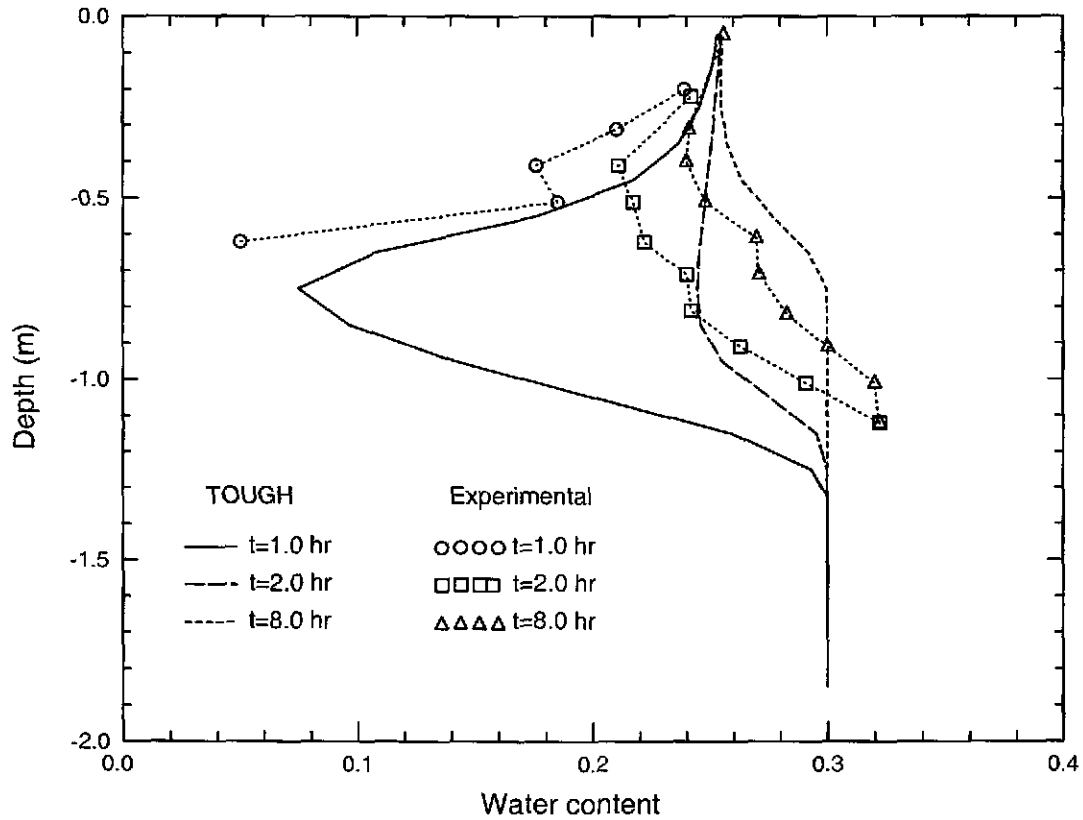
The acceptance criteria for Test Case #4 are comparisons with confirmed published data and technical literature, comparisons with other independently developed software of similar purpose (*i. e.*, TOUGH), independent calculations, and manual inspection of the output from the test case. Results from Test Case #4 should agree reasonably well with the results for the same test case run using TOUGH and with experimental results. Exact agreement is not expected because both BRAGFLO and TOUGH involve numerical solutions to differential equations, which are by

nature approximations to the true solutions. Agreement with experimental results will not be exact because of the nature of experimental measurements. However, BRAGFLO results should show very similar behavior to both TOUGH and experimental results. These results should validate Functional Requirements R.15 and R.16.

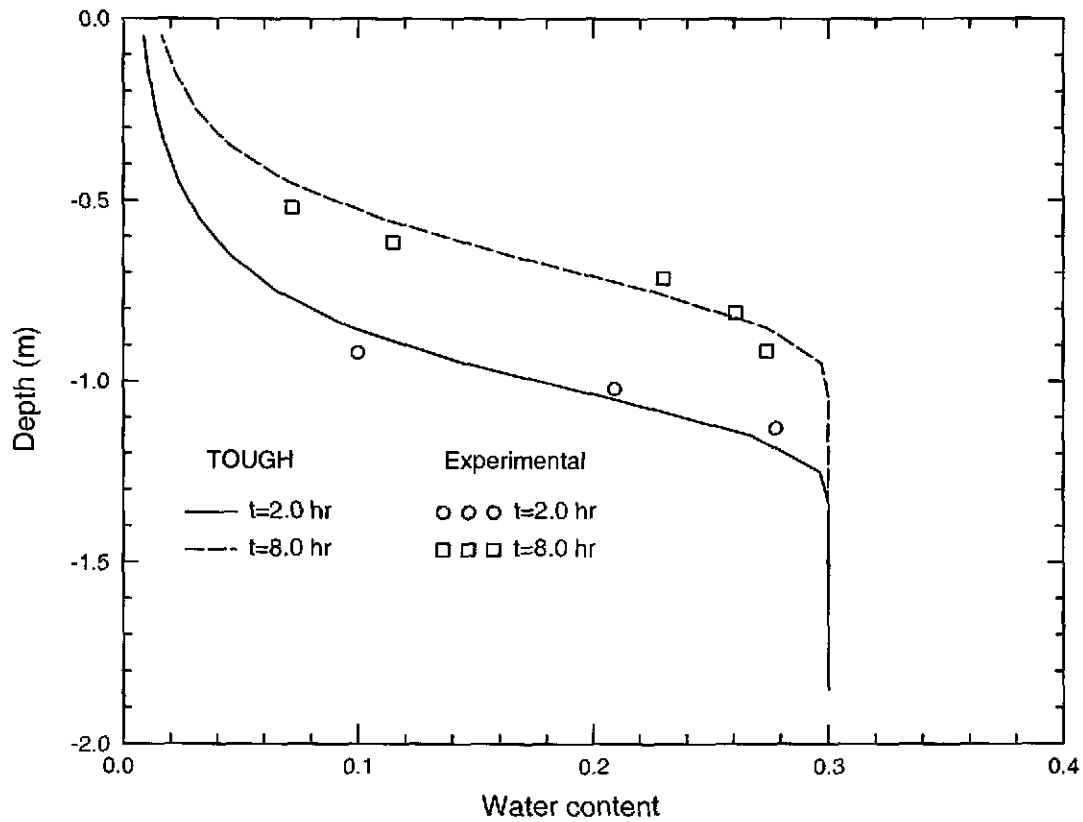
Independent calculations should confirm that the relative permeability's are calculated correctly. Using values of brine saturation at any grid block reported in the output files, the values of relative permeability and capillary pressure obtained by independent calculation should agree to three significant figures unless fewer digits are provided in the relevant BRAGFLO output or input file. These independent calculations should validate Functional Requirement R.8.

Visual inspection of the ASCII output file should confirm that the input that describes the test case has been read in correctly. Output values should agree with values in the input file to the least number of significant figures reported in either file, verifying Functional Requirements R.1 to R.3, R.5 to R.7, R.11, R.12, and R18. Close agreement of BRAGFLO results with TOUGH results listed in Table 9.4.1 and experimental results should further validate these Functional Requirements by showing that the description of the test case has been properly treated numerically.

**FIGURE 9.4.1 COMPARISON OF TOUGH AND EXPERIMENTAL RESULTS FOR TEST CASE #4, TWO-DIMENSIONAL INFILTRATION, AT DISTANCE X = 0.19 M**



**FIGURE 9.4.2 COMPARISON OF TOUGH AND EXPERIMENTAL RESULTS FOR TEST CASE #4, TWO-DIMENSIONAL INFILTRATION, AT DISTANCE X = 1.39 M**



**TABLE 9.4.1 RESULTS FROM TOUGH RUN ON TEST CASE #4  
 BF2\_TEST4\_T019.DAT**

Depth, m	Water content, @ 1 hr	Water content, @ 2 hr	Water content, @ 8 hr
-0.185000E+01	0.300000E+00	0.300000E+00	0.299998E+00
-0.160000E+01	0.300000E+00	0.300000E+00	0.299996E+00
-0.145000E+01	0.300000E+00	0.300000E+00	0.299995E+00
-0.137500E+01	0.300000E+00	0.299998E+00	0.299995E+00
-0.132500E+01	0.299741E+00	0.299995E+00	0.299995E+00
-0.125000E+01	0.293448E+00	0.299832E+00	0.299995E+00
-0.115000E+01	0.259416E+00	0.295374E+00	0.299995E+00
-0.105000E+01	0.200817E+00	0.275683E+00	0.299995E+00
-0.950000E+00	0.141698E+00	0.255134E+00	0.299995E+00
-0.850000E+00	0.968315E-01	0.246188E+00	0.299995E+00
-0.750000E+00	0.746775E-01	0.244559E+00	0.299524E+00
-0.650000E+00	0.107866E+00	0.245577E+00	0.292184E+00
-0.550000E+00	0.175588E+00	0.247272E+00	0.276760E+00
-0.450000E+00	0.217329E+00	0.249016E+00	0.263738E+00
-0.350000E+00	0.236401E+00	0.250650E+00	0.257223E+00
-0.250000E+00	0.245551E+00	0.252151E+00	0.254987E+00
-0.150000E+00	0.250445E+00	0.253514E+00	0.254731E+00
-0.500000E-01	0.253323E+00	0.254704E+00	0.255223E+00

**BF2\_TEST4\_T139.DAT**

Depth, m	Water content, @ 1 hr	Water content, @ 2 hr	Water content, @ 8 hr
-0.185000E+01	0.300000E+00	0.300000E+00	0.300000E+00
-0.160000E+01	0.300000E+00	0.300000E+00	0.299998E+00
-0.145000E+01	0.300000E+00	0.300000E+00	0.299996E+00
-0.137500E+01	0.300000E+00	0.300000E+00	0.299995E+00
-0.132500E+01	0.299753E+00	0.299900E+00	0.299995E+00
-0.125000E+01	0.293754E+00	0.296374E+00	0.299995E+00
-0.115000E+01	0.260233E+00	0.267609E+00	0.299995E+00
-0.105000E+01	0.201661E+00	0.209473E+00	0.299999E+00
-0.950000E+00	0.142053E+00	0.145442E+00	0.297273E+00
-0.850000E+00	0.963190E-01	0.968238E-01	0.273986E+00
-0.750000E+00	0.654303E-01	0.654490E-01	0.224906E+00
-0.650000E+00	0.454165E-01	0.454184E-01	0.163896E+00
-0.550000E+00	0.324071E-01	0.324112E-01	0.110138E+00
-0.450000E+00	0.237719E-01	0.237745E-01	0.708199E-01
-0.350000E+00	0.178859E-01	0.178875E-01	0.455588E-01
-0.250000E+00	0.137646E-01	0.137661E-01	0.310136E-01
-0.150000E+00	0.108054E-01	0.108072E-01	0.223133E-01
-0.500000E-01	0.863170E-02	0.863365E-02	0.163043E-01



## **9.5 Test Case #5. Two-dimensional, two-phase flow with gas injection.**

### **9.5.1 Test Objective**

The purpose of this test is to verify the ability of BRAGFLO to model gas injection (or generation) and the subsequent migration of gas in a two-phase system (Functional Requirements R.15 and R.16). In addition, this test case tests the basic Functional Requirements R.1 to R.3, R.5 to R.7, and R.18, which describe the problem being tested, and R.11 and R.12, the equations of state for fluids.

This problem consists of a two-dimensional vertical cross section with a gas injection well located at the center of a 22m by 21m region. Because of symmetry with respect to a vertical plane through the well, only the solution on the right half of the region needs to be obtained, so a 11m by 21m region is modeled. The reservoir is initialized to gravity/capillary equilibrium. Gas is injected at a constant rate from initial time until time  $1.0 \times 10^7$  s. TOUGH was run on the same problem to provide a comparison for the BRAGFLO results. The TOUGH results are shown in Figures 9.5.1 to 9.5.4. Gas pressure and gas saturation profiles horizontally outward from the well at the end of the simulation are shown in Figures 9.5.1 and 9.5.2, respectively. Vertical profiles through the well are shown in Figures 9.5.3 and 9.5.4.

### **9.5.2 Test Procedure**

The BRAGFLO validation tests are run using the WIPP PA run control system. The scripts and script input files that run the validation tests are stored in CMS. All test inputs are fetched at run time by the scripts. All test outputs/results and run logs are stored in CMS by the scripts in class QB0600 of the CMS library, WP\$CMSROOT:[BF]. Other files related to the validation of BRAGFLO 6.0 are submitted for storage in CMS by the SCMS Librarian and reside in QB0600 class of the CMS library.

The Fortran code, BF2\_TEST5\_BFDAT.FOR, was used in the validation of BRAGFLO 4.10. It may need to be modified to accommodate additional information in the ASCII output file, BF2\_QB0600\_TEST5.OUT for BRAGFLO 6.0, but all files and code used in the validation will be stored in CMS class QB0600. The executable file of the Fortran code is run to extract pressure and saturation data from the output file, BF2\_QB0600\_TEST5.OUT, at time  $1.0 \times 10^7$  s, the final printout time, and create data files as listed in Table 9.5.1. The corresponding TOUGH results are in the files listed in Table 9.5.2, the contents of which are shown in Table 9.5.3. SPLAT is then used to generate plots of BRAGFLO results corresponding to the plots of TOUGH results in Figures 9.5.1 through 9.5.4.

### **9.5.3 Input Files**

The BRAGFLO input files for Test Case #5 are called BF2\_QB0600\_TEST5.INP and BF2\_CLOSURE.DAT. Additional parameters have been added to the input file to suppress the new models added to BRAGFLO 6.0 compared with BRAGFLO 5.0. Otherwise, the input file,

BF2\_QB0600\_TEST5.INP, is identical to BF2\_QA0500\_TEST5.INP, which is the input file for Test Case #5 in the validation of BRAGFLO 5.0.

**TABLE 9.5.1 DATA FILES PRODUCED BY  
 BF2\_TEST5\_BFDAT.FOR, TEST CASE #5**

BF2_QB0600_TEST5_BFHX.DAT	BRAGFLO pressure	vs. horizontal distance outward from well
BF2_QB0600_TEST5_BFHX.DAT	BRAGFLO saturation	vs. horizontal distance outward from well
BF2_QB0600_TEST5_BFVX.DAT	BRAGFLO pressure	vs. vertical distance from top downward through well
BF2_QB0600_TEST5_BFVX.DAT	BRAGFLO saturation	vs. vertical distance from top downward through well

**TABLE 9.5.2 DATA FILES PRODUCED FOR TOUGH RESULTS  
 TEST CASE #5**

BF2_TEST5_THHX.DAT	TOUGH pressure	vs. horizontal distance outward from well
BF2_TEST5_THHX.DAT	TOUGH saturation	vs. horizontal distance outward from well
BF2_TEST5_THVX.DAT	TOUGH pressure	vs. vertical distance from top downward through well
BF2_TEST5_THVX.DAT	TOUGH saturation	vs. vertical distance from top downward through well

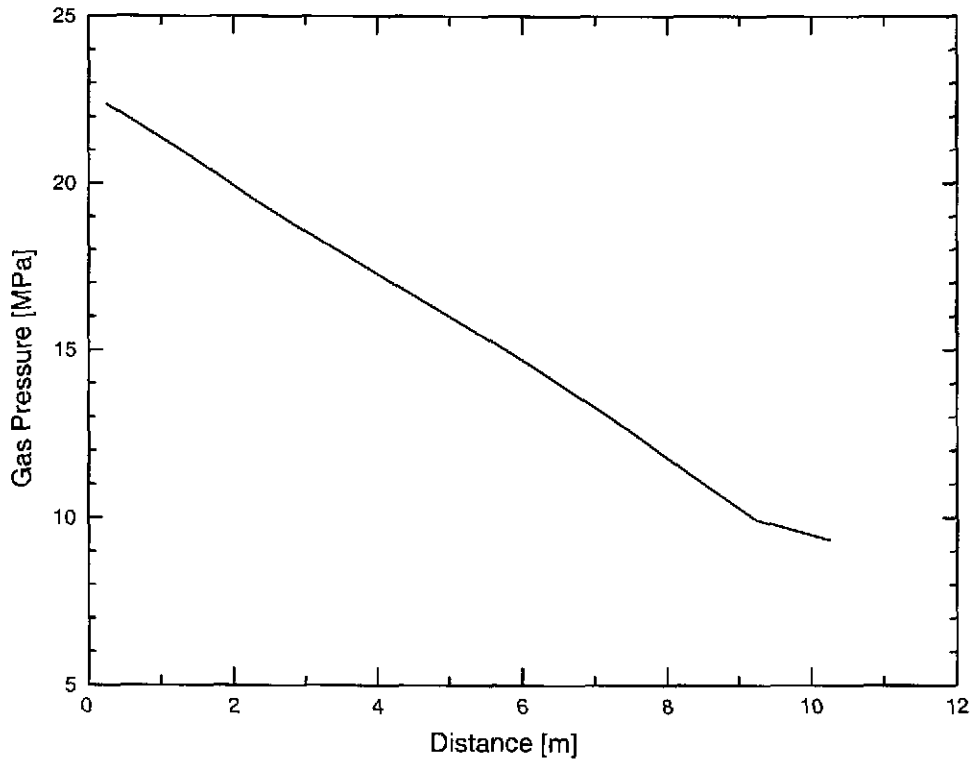
#### 9.5.4 Acceptance Criteria

The acceptance criteria for Test Case #5 are comparisons with other independently developed software of similar purpose (i. e., TOUGH), together with manual inspection of the output from the test case. Results from Test Case #5 should agree reasonably well with the results for the same test case run using TOUGH. Exact agreement is not expected because both BRAGFLO and TOUGH involve numerical solutions to differential equations, which are by nature approximations to the true solutions. However, BRAGFLO results should show very similar behavior to TOUGH, and track TOUGH results very closely. These results should verify Functional Requirements R.15 and R.16.

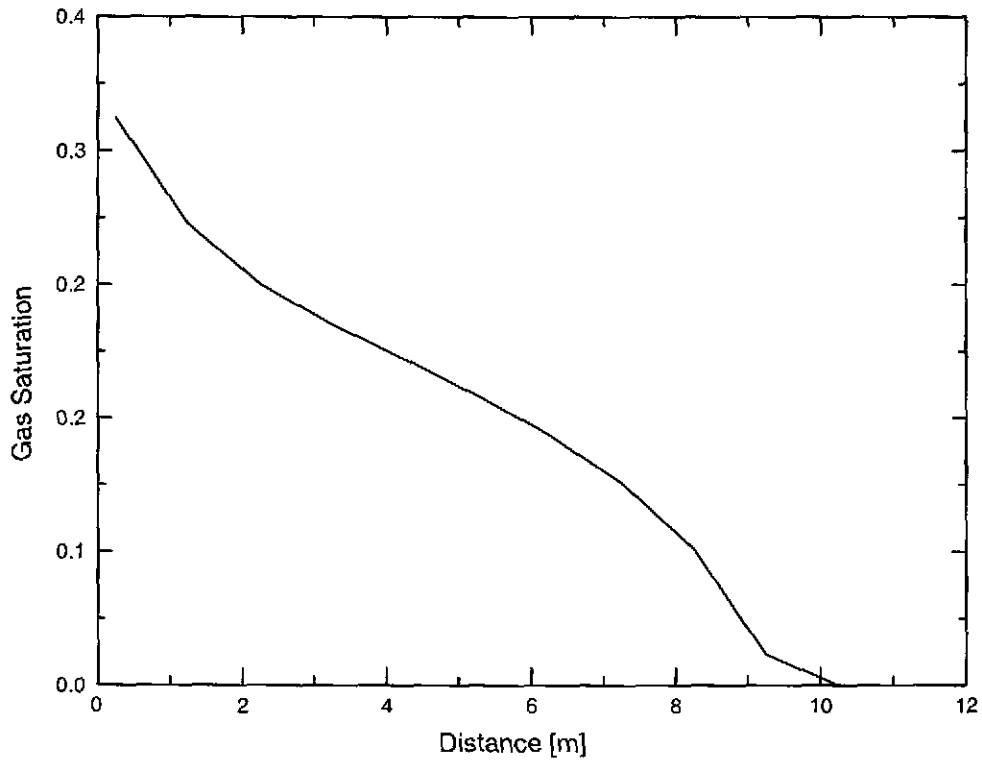
Visual inspection of the ASCII output file should confirm that the input that describes the test case has been read in correctly. Output values should agree with values in the input file, verifying Functional Requirements R.1 to R.3, R.5 to R.7, R.11, R.12, and R.18. Close

agreement between BRAGFLO and TOUGH should further validate these Functional Requirements by showing that the description of the test case has been properly treated numerically.

**FIGURE 9.5.1 TOUGH RESULTS FOR TEST CASE #5, GAS INJECTION. GAS PRESSURES IN HORIZONTAL CROSS SECTION THROUGH THE WELL AT TIME  $T = 1.0 \times 10^7$  S**



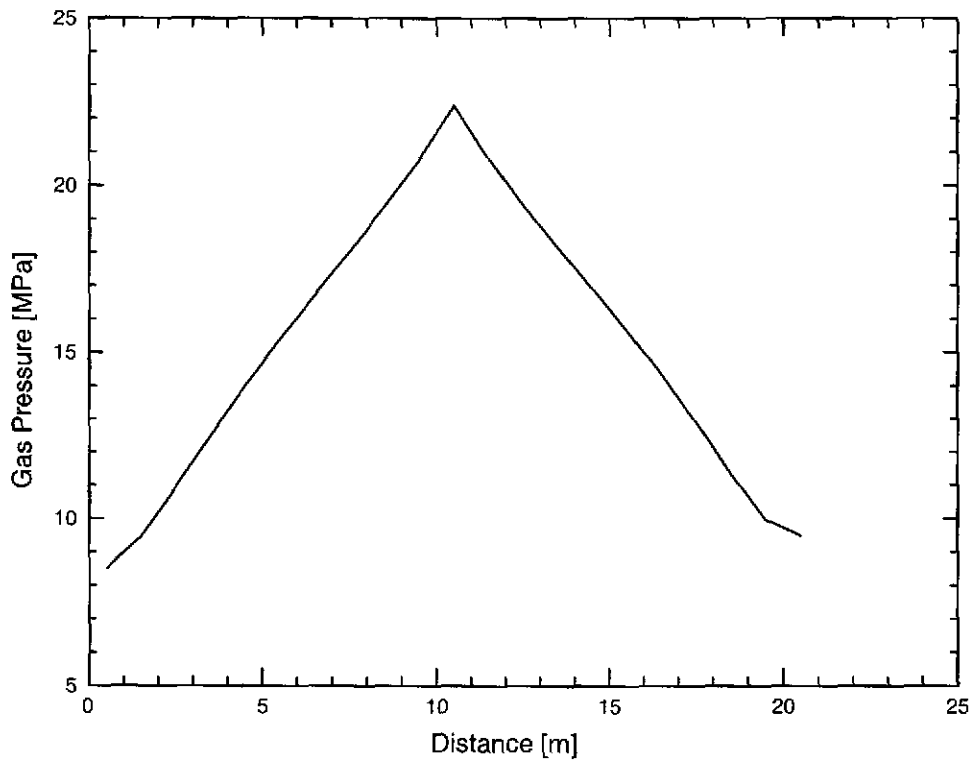
**FIGURE 9.5.2 TOUGH RESULTS FOR TEST CASE #5, GAS INJECTION. GAS SATURATIONS IN HORIZONTAL CROSS SECTION THROUGH THE WELL AT TIME  $T = 1.0 \times 10^7$  S**



U1:JDSCHRE:BRAGFLO\_QA\_95.2D:GASIN:JBF2\_TESTS\_THSX.CMD.2

SPLAT X2.0 09/27/95 11:38:01

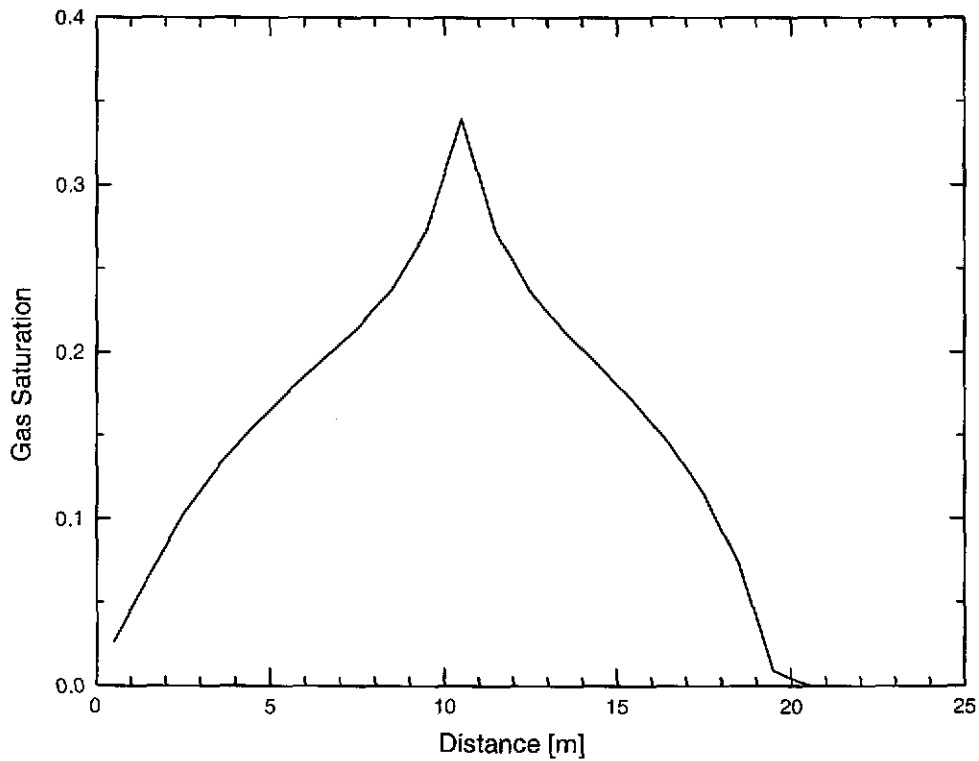
**FIGURE 9.5.3 TOUGH RESULTS FOR TEST CASE #5, GAS INJECTION. GAS PRESSURES IN VERTICAL CROSS SECTION THROUGH THE WELL AT TIME  $T = 1.0 \times 10^7$  s**



U1:\JDSCHRE\BRAGFLO.GA\_85.2\GASIN\JBF2\_TESTS\_TVPX.CMD;1

SPLAT X2.0 09/27/95 11:40:02

**FIGURE 9.5.4 TOUGH RESULTS FOR TEST CASE #5, GAS INJECTION. GAS SATURATIONS IN VERTICAL CROSS SECTION THROUGH THE WELL AT TIME  $T=1.0 \times 10^7$  S**



U:\JDSCHRE\BRAGFLO\_GA\_95\_2DGASIN\JBF2\_TEST5\_TV5X.CMD:1

SPLAT X2.0 09/27/95 11:42:16

**TABLE 9.5.3 RESULTS FROM TOUGH RUN ON TEST CASE #5  
 BF2\_TEST5\_THHX.DAT**

Distance, m	$P_g$ , MPa	$S_g$
0.25	22.376	0.33961
1.25	21.040	0.27623
2.25	19.564	0.24034
3.25	18.231	0.21602
4.25	16.962	0.19553
5.25	15.697	0.17386
6.25	14.369	0.15003
7.25	12.940	0.12108
8.25	11.397	0.08178
9.25	9.924	0.01856
10.25	9.344	0.00000

**BF2\_TEST5\_THVX.DAT**

Distance, m	$P_g$ , MPa	$S_g$
0.5	8.505	0.02636
1.5	9.450	0.06498
2.5	10.931	0.10241
3.5	12.490	0.13112
4.5	13.978	0.15464
5.5	15.374	0.17554
6.5	16.699	0.19523
7.5	18.005	0.21444
8.5	19.340	0.23769
9.5	20.764	0.27295
10.5	22.376	0.33961
11.5	20.800	0.27246
12.5	19.427	0.23662
13.5	18.156	0.21249
14.5	16.924	0.19182
15.5	15.676	0.16986
16.5	14.350	0.14557
17.5	12.915	0.11526
18.5	11.361	0.07344
19.5	9.967	0.00919
20.5	9.493	0.00000

## **9.6 Test Case #6. Two-dimensional WIPP preliminary performance assessment calculation.**

### **9.6.1 Test Objective**

The purpose of this test is to exercise functional requirements that are specific to WIPP performance assessment calculations but which were not tested in Test Cases #1-5. These include tests of: 1) gas generation resulting from corrosion and biodegradation reactions [Functional Requirement R.13]; 2) creep closure of the repository [R.14]; 3) fracturing of interbeds [R.9]; 4) Klinkenberg effect [R.10]; 5) relative permeability and capillary pressure models [R.8]; 6) gas and brine density calculations [R.11 and R.12]; 7) porosity calculations in materials other than waste [R.7 and R.9]; 8) introduction of a borehole at the time of a human intrusion [R.7]; 9) reading an input file prepared by PREBRAG [External Interface Requirement R.25]; 10) postprocessing using POSTBRAG [R.27]; and 11) reading a porosity-surface input file created by SANTOS [R.26]. Functional Requirement R.17 (flow in heterogeneous materials) is not tested explicitly because this test case is too complex to be a valid test of that feature, but R.17 is utilized extensively in this test. Manual comparison confirms that output files contain correct values for input parameters [Functional Requirement R.18]. In addition, this test case tests the basic Functional Requirements R.1 to R.3, R5 and R6, which describe the problem being tested, and R.15, the calculation of two-phase flow.

This test case is modification of a single realization from a Latin hypercube sampling used in a preliminary performance assessment calculation. It is expected to be similar to an actual compliance calculation using BRAGFLO in that all the features to be used in compliance calculations will be in effect. The test case simulates a human intrusion into the WIPP repository 1000 years after the repository is decommissioned (E1 scenario) and covers the 10,000-year compliance period. It is similar to Vector 7 of Test Case #7 except that Test Case #6 uses higher corrosion and biodegradation rates in order to generate sufficient pressures for fracturing to occur.

### **9.6.2 Test Procedure**

The BRAGFLO validation tests are run using the WIPP PA run control system. The scripts and script input files that run the validation tests are stored in CMS. All test inputs are fetched at run time by the scripts. All test outputs/results and run logs are stored in CMS by the scripts in class QB0600 of the CMS library, WP\$CMSROOT:[BF]. Other files related to the validation of BRAGFLO 6.0 are submitted for storage in CMS by the SCMS Librarian and reside in QB0600 class of the CMS library. The binary output file is then post-processed using POSTBRAG, with an input .CDB file, BF2\_TEST6\_ALGEBRA.CDB, to produce an output .CDB file, BF2\_QB0600\_TEST6.CDB, which can be examined using GROPE or BLOT.

### **9.6.3 Input Files**

The BRAGFLO input files for Test Case #6 are called BF2\_QB0600\_TEST6.INP and BF2\_CLOSURE.DAT. Additional parameters have been added to the input file to suppress the



new models added to BRAGFLO 6.0 compared with BRAGFLO 5.0. Otherwise, the input file, BF2\_QB0600\_TEST6.INP, is identical to BF2\_QA0500\_TEST6.INP, which is the input file for Test Case #6 in the validation of BRAGFLO 5.0. Output values should agree with values in the input file to the least number of significant figures that are reported in either file, verifying Functional Requirements R.1 to R.3, R.5 to R.7, R.11, R.15, and R.18.

#### 9.6.4 Acceptance Criteria

The acceptance criteria for Test Case #6 are independent calculations and manual inspection of the output to verify that BRAGFLO is performing the calculations correctly. The independent calculations will be done using values of pressures and saturations reported in output files. The results from BRAGFLO and independent calculations should agree to three significant figures unless fewer digits are provided in the relevant BRAGFLO output or input file.

##### *Gas generation.*

The calculation of gas generation via corrosion of iron and microbial degradation of cellulose has been described in WIPP PA (5,16) and in Helton et al. (17), and will be summarized briefly here.

The gas generation rate is assumed to be of the form

$$q_r = M_{w,H_2} (s_{H_2,Fe} q_{rc} + s_{H_2,CH_2O} q_{rm}) \quad (9.6.1)$$

where  $q_{rc}$  is the rate of production of gas resulting from the corrosion of iron ( $\text{mol Fe m}^{-3} \text{s}^{-1}$ ), and  $q_{rm}$  is the rate of production of gas resulting from the microbial degradation of cellulose ( $\text{mol CH}_2\text{O m}^{-3} \text{s}^{-1}$ ). The stoichiometric coefficients,  $s_{H_2,Fe}$  ( $\text{mol H}_2/\text{mol Fe}$ ) and  $s_{H_2,CH_2O}$  ( $\text{mol H}_2/\text{mol CH}_2\text{O}$ ), convert the rates from a reactant basis to a product ( $\text{H}_2$ ) basis. The molecular weight of  $\text{H}_2$  is  $M_{w,H_2} = 2.01588 \times 10^{-3} \text{ kg/mol}$ ; this value is set in the input file, and, as confirmation, it is printed to the ASCII output file. Gas generation takes place only within the waste panels and all generated gas is assumed to be  $\text{H}_2$ . The rates  $q_{rc}$  and  $q_{rm}$  are defined by

$$\begin{aligned} q_{rc} &= r_{ci} S_w + r_{ch} S_{nw} \\ q_{rm} &= r_{mi} S_w + r_{mh} S_{nw} \end{aligned} \quad (9.6.2)$$

where  $r_{ci}$  is the rate of corrosion of iron under inundated conditions ( $\text{mol Fe m}^{-3} \text{s}^{-1}$ );  $r_{ch}$  is the rate of corrosion of iron under humid conditions ( $\text{mol Fe m}^{-3} \text{s}^{-1}$ );  $r_{mi}$  is the rate of microbial degradation of cellulose ( $\text{CH}_2\text{O}$ ) under inundated conditions ( $\text{mol CH}_2\text{O m}^{-3} \text{s}^{-1}$ ); and  $r_{mh}$  is the rate of microbial degradation of cellulose under humid conditions ( $\text{mol CH}_2\text{O m}^{-3} \text{s}^{-1}$ ).  $S_w$  is the brine or wetting-phase saturation, and  $S_{nw}$  is the gas or non-wetting-phase saturation ( $S_{nw} = 1 - S_w$ ). The rates under humid conditions are input as factors,  $f_c$  and  $f_m$ , that multiply the rates under inundated conditions:

$$\begin{aligned}r_{ch} &= f_c r_{ci} \\r_{mh} &= f_m r_{mi}\end{aligned}\tag{9.6.3}$$

The tester should verify by manual inspection that the following values specified in the input file are reported in the output file, BF2\_QB0600\_TEST6.OUT:

$$\begin{aligned}r_{ci} &= \text{RK}(1) = 3.000 \times 10^{-8} \text{ mol Fe m}^{-3} \text{ s}^{-1}, \\r_{mi} &= \text{RK}(2) = 1.500 \times 10^{-7} \text{ mol CH}_2\text{O m}^{-3} \text{ s}^{-1}, \\f_c &= \text{HF}(1) = 1.000 \times 10^{-3}, \\f_m &= \text{HF}(2) = 0.2, \\s_{\text{H}_2, \text{Fe}} &= \text{S}(1,1) = 1.3081 \text{ mol H}_2/\text{mol Fe}, \\s_{\text{H}_2, \text{CH}_2\text{O}} &= \text{S}(2,1) = 1.1100 \text{ mol H}_2/\text{mol CH}_2\text{O}.\end{aligned}$$

Because BRAGFLO solves the mass balance equations using a fully implicit technique, all values of dependent variables (gas saturation and brine pressure), as well as all functions of these variables, are valid over the time step just completed. Therefore, the tester can use any reported values at any time for verification simply by inserting the values into the equations above and should find agreement with the results printed to the output file.

The tester can use either the ASCII output file, BF2\_QB0600\_TEST6.OUT, or, after applying POSTBRAG to the binary output file, BF2\_QB0600\_TEST6.BIN, to produce a CAMDAT file, BF2\_QB0600\_TEST6.CDB, and then use GROPE to select data at a particular grid block. To test gas generation, results from a waste grid block must be selected. For this test case, there are 30 waste cells with (I,J,K)-indexes ranging from I = 8 to 10 and 12 to 18 and J = 8 to 10. If GROPE is used to extract data from the .CDB file, the waste elements are numbers 436 to 465.

At any time after zero, choose a waste grid block, and find the values of either gas saturation or brine saturation, or both (although, since  $S_w = 1 - S_{nw}$ , only one of the saturations is needed). Using the values for inundated reaction rates,  $r_{ci}$  and  $r_{mi}$ , and the humid rate factors,  $f_c$  and  $f_m$ , calculate the humid reaction rates,  $r_{ch}$  and  $r_{mh}$ , using equations 9.6.3. Then, using the stoichiometric coefficients,  $s_{\text{H}_2, \text{Fe}}$  and  $s_{\text{H}_2, \text{CH}_2\text{O}}$ , calculate the gas generation rates from each reaction using equations 9.6.2. After summing these (equation 9.6.1), the result should agree to three or four significant figures with the value reported in the BRAGFLO output file under “H2 generation rate -- simple model” (H2RATE in the .CDB file). Values can be checked in as many of the 30 waste grid blocks as necessary to satisfy the testers needs.

Additional tests that gas generation is being calculated properly can be made at the tester’s discretion. The BRAGFLO output file also reports individually the “Inundated corrosion rate” (or CORRATI), the “Humid corrosion rate” (or CORRATH), the “Inundated biodegradation rate” (or BIORATI), and the “Humid biodegradation rate” (or BIORATH); these are, respectively:

$$\begin{aligned} q_{rci} &= r_{ci} S_w V \\ q_{rch} &= r_{ch} S_{nw} V \end{aligned} \quad (9.6.4)$$

$$\begin{aligned} q_{rmi} &= r_{mi} S_w V \\ q_{rmh} &= r_{mh} S_{nw} V \end{aligned} \quad (9.6.5)$$

where  $q_{rci}$  and  $q_{rch}$  have units of mol Fe/s and  $q_{rmi}$  and  $q_{rmh}$  have units of mol CH<sub>2</sub>O/s.

In addition, using other stoichiometric factors, other quantities related to gas generation can be tested, including “Brine consumption rate -- simple model” (or BRINRATE), “Fe consumption rate -- simple model” (or FERATE), and “Biodegrad consumption rate -- simple model” (or CELLRATE). The following stoichiometric coefficients should be found in the output file:

$$\begin{aligned} s_{H_2O,Fe} &= S(1,2) = \text{H}_2\text{O coefficient} = 1.3838 \text{ mol H}_2\text{O/mol Fe} \\ s_{H_2O,CH_2O} &= S(2,2) = \text{H}_2\text{O coefficient} = 0.0 \text{ mol H}_2\text{O/mol CH}_2\text{O} \\ s_{Fe} &= S(1,3) = \text{Fe coefficient} = -1.0 \text{ mol Fe/mol Fe} \\ s_{Bio} &= S(2,4) = \text{Bio coefficient} = -1.0 \text{ mol CH}_2\text{O/mol CH}_2\text{O}. \end{aligned}$$

Because the consumption rates are reported in kg m<sup>-3</sup> s<sup>-1</sup>, the following molecular weights, which should be found in the output file, are also needed:

$$\begin{aligned} M_{w,H_2O} &= \text{WM}(2) = 1.801528 \times 10^{-2} \text{ kg H}_2\text{O/mol H}_2\text{O} \\ M_{w,Fe} &= \text{WM}(3) = 5.5847 \times 10^{-2} \text{ kg Fe/mol Fe} \\ M_{w,CH_2O} &= \text{WM}(4) = 3.0026 \times 10^{-2} \text{ kg CH}_2\text{O/mol CH}_2\text{O}. \end{aligned}$$

In addition, for brine consumption, the salinity of brine, in weight percent salt, should be obtained from the output file, where it is echoed from the input:

$$m_s = \text{SALT} = 29.6 \text{ wt } \%$$

The brine consumption rate, in units of kg brine m<sup>-3</sup> s<sup>-1</sup>, is calculated from:

$$q_b = - \left[ \frac{M_{w,H_2O}}{1 - \frac{m_s}{100}} \right] [s_{H_2O,Fe} (r_{ci} S_w + r_{ch} S_{nw}) + s_{H_2O,CH_2O} (r_{mi} S_w + r_{mh} S_{nw})] \quad (9.6.6)$$

In any waste grid block,  $q_b$  should agree with the value reported as “Brine consumption rate” (or BRINRATE), to three or four significant figures. The result should be negative, indicating consumption rather than generation.

The iron consumption rate, in  $\text{kg Fe m}^{-3} \text{ s}^{-1}$ , is computed from:

$$\begin{aligned} q_{Fe} &= -M_{w,Fe} (r_{ci} S_w + r_{ch} S_{nw}) \\ &= -M_{w,Fe} q_{rc} \end{aligned} \tag{9.6.7}$$

The biodegradables consumption rate, in  $\text{kg CH}_2\text{O m}^{-3} \text{ s}^{-1}$ , is computed from:

$$\begin{aligned} q_{CH_2O} &= -M_{w,CH_2O} (r_{mi} S_w + r_{mh} S_{nw}) \\ &= -M_{w,CH_2O} q_{rm} \end{aligned} \tag{9.6.8}$$

Both of these —  $q_{Fe}$  and  $q_{CH_2O}$  — should agree three or four significant figures with values of “Fe consumption rate” (or FERATE) and “Biodegrad consumption rate” (or CELLRATE), respectively, reported in the BRAGFLO output files.

Satisfactory agreement between these independent calculations and values reported in the ASCII output file will verify Functional Requirement R.13. Agreement with values reported in the .CDB file, along with other checks in this test case, will verify External Interface Requirement R.25.

#### *Creep closure.*

BRAGFLO calculates the porosity of materials that undergo creep closure by interpolating over “porosity surfaces.” These surfaces are values of porosity as a function of time and brine pressure that were obtained by modeling deformation of a waste-filled or empty room using the code, SANTOS. [The SANTOS room deformation calculations are discussed in WIPP PA (16).] The surfaces are represented in BRAGFLO as discrete points, loaded into an input file (BF2\_CLOSURE.DAT). Four surfaces are available, corresponding to the following conditions: 1) waste-filled room with no backfill; 2) non-backfilled excavation (access drifts and “North End”); 3) waste-filled room with backfill; and 4) improved surface for waste-filled room with no backfill. Surfaces 1, 2, and 3 are now obsolete; only surface 4 is tested. The only material that is assumed to undergo dynamic creep closure is waste material.

BRAGFLO performs two key operations in calculating the porosity of materials that undergo creep closure. First, it must select the proper surface to use for a given material. Second, it must interpolate over the surface, given the time and brine pressure. Because the algorithm BRAGFLO uses to identify the appropriate porosity values to use for the interpolation is fairly complex, a complete independent calculation would be very difficult. Therefore, the acceptance criterion for creep closure is simply to show that, at any grid cell in the waste, at any time and brine pressure found in the BRAGFLO output file, the porosity should be within a few percent of the value found using Figures 9.6.1 and 9.6.2 to interpolate porosity values. More exact

agreement can be achieved if the tester is willing to work through the entire interpolation scheme used in BRAGFLO, but the small additional degree of confidence that BRAGFLO is performing correctly is probably not worth the considerable effort required.

To carry out the test, the tester should select a time at which BRAGFLO has output results for porosity in the waste. Use of the porosity surfaces is discontinued if the brine pressure exceeds lithostatic pressure, 14.8 MPa, so the tester must first ascertain that creep closure is still active. One way to do this is to examine a pressure history of the grid block selected, using either GROPE or BLOT on the .CDB file. Then select a time prior to the first occurrence of brine pressure of 14.8 MPa. Another way to check that creep closure is active at the time and location selected is to examine the summary (.SUM) file, in which an informational message is printed when closure is turned off. This message has the form:

```
** CLOSURE turned off temporarily in <subroutine name> in xx grid blocks:  
  
#,I,J,K,MKL,PO,SG= NN II JJ KK   M   1.4954E+07   7.2841E-01
```

where NN is the number of grid blocks turned off at that time; II, JJ, and KK are the actual (I, J, K)-indexes of those grid blocks; M is the surface number (4 for the surface used, waste without backfill); and PO and SG are the brine pressure and gas saturation when closure is turned off temporarily. Then there will be a subsequent message informing that closure has been turned off permanently:

```
** CLOSURE turned off permanently in xxx grid blocks in <subroutine name>.
```

If the message:

```
** CLOSURE turned off permanently in ALL xxxx grid blocks in <subroutine name>.
```

appears, then creep closure has been deactivated everywhere in the mesh. In Test Case #6, this occurs at 720.3 years ( $2.273 \times 10^{10}$  s), so creep closure must be tested at a time earlier than this.

After selecting a time, choose any grid block in the waste and find the brine pressure. Use Figure 9.6.1A or Figure 9.6.2A, to interpolate linearly (by sight) in order to get the f-value. Then, for the same time and f-value, read the porosity from the vertical axis of Figure 9.6.1B or Figure 9.6.2B. This value should agree within a few percent (depending on how accurately the tester can interpolate visually on a graph) with the value reported in the .CDB file under the element variable POROS. This verifies Functional Requirement R.1, R.14, and R.26.

*Fracturing of Interbeds.*

The fracture model in BRAGFLO allows the porosity and permeability of certain materials to vary dynamically with the brine pressure when the pressure is within a specified range. This model is verified using independent calculations.

At pressures,  $p$ , below an initiation pressure,  $p_i$ , the porosity,  $\phi$ , is computed from a constant rock compressibility,  $C_i$ :

$$\phi = \phi_o \exp[C_i(p - p_o)], \quad p \leq p_i \quad (9.6.9)$$

where  $\phi_o$  is the porosity at the reference pressure,  $p_o$ . At pressures above the initiation pressure but below  $p_a$ , which is the pressure at which conditions are fully altered, the porosity is given by:

$$\phi = \phi_o \exp\left[C_i(p - p_o) + \frac{(C_a - C_i)(p - p_i)^2}{2(p_a - p_i)}\right], \quad p_i < p \leq p_a \quad (9.6.10)$$

The fully altered compressibility,  $C_a$ , is given by:

$$C_a = C_i \left[1 - 2 \frac{(p_a - p_o)}{(p_a - p_i)}\right] + \frac{2}{(p_a - p_i)} \ln\left(\frac{\phi_a}{\phi_o}\right) \quad (9.6.11)$$

The BRAGFLO fracture treatment also allows the permeability of the fracture material to change, using the parallel plate analogy for flow in fractured rock:

$$k = k_i \left[\frac{\phi}{\phi_i}\right]^n \quad (9.6.12)$$

where

- $k$  = permeability of altered material,
- $k_i$  = permeability of intact material,
- $\phi$  = porosity of altered material,
- $\phi_i$  = porosity of intact material at  $p = p_i$ , evaluated using equation 9.6.9,
- $n$  = an empirical parameter.

At pressures above the pressure corresponding to fully altered conditions, the porosity is specified to be  $\phi = \phi_a$ , the fully altered porosity.

The tester should first verify that the following values have been read correctly from the input file and reported to the output file for each fracture material:

FRPIINC	= $p_i - p_o$	= pressure increment over initial pressure at which the fracture is initiated.
FRPFINC	= $p_a - p_i$	= pressure increment over fracture initiation pressure, $p_i$ , at which the fracture is fully developed and the material is fully altered.
FRPHIMAX	= $\phi_a$	= maximum allowable fracture, or fully altered, porosity.
FRPRMEXP	= $n$	= empirical exponent relating permeability to porosity, in equation 9.6.12.
IFRX		= flag to indicate whether x-direction permeability will be calculated for fractured material.
IFRY		= flag to indicate whether y-direction permeability will be calculated for fractured material.
IFRZ		= flag to indicate whether z-direction permeability will be calculated for fractured material.
PORROCKMAT	= $\phi_o$	= porosity of intact rock at reference pressure.
CROCK	= $C_i$	= compressibility of intact rock at reference pressure.

The initial pressures,  $p_o$ , which are also the reference pressures, can be obtained only from the input file; they are not echoed to the output file. Also, be aware that the BRAGFLO compliance calculations, of which Test Case #6 is an example, start at -5 years, so that the pressure distribution at time zero differs from that at the start of the run, when the initial (reference) pressures are set. Verification that the pressures are initialized correctly can only be done indirectly. Verification of the fracture model is one way to verify indirectly the initial pressures.

The tester should select a grid block having a material that undergoes fracturing and a time when that grid block is known to have fractured. Fractured conditions can be detected in the .CDB file using GROPE by observing the history of brine permeability in the x-direction, PERMBRX, in the selected grid block or element. When PERMBRX deviates from the initial intact value, fracturing has occurred, and any output from a time step where fracturing has occurred can be used in the independent calculation. An alternative is to use the results from the ASCII output file at 900 years, when fracturing is known to have occurred in this test case in some of the anhydrite layer grid blocks. Using the brine pressure in the selected grid block (or PRESBRIN in the selected element from GROPE), the tester should calculate the porosity of that cell using equations 9.6.10 and 9.6.11. The calculated values should agree to within round-off with the value of porosity reported in the output. Next, using that value of porosity, calculate the permeability of the grid cell using equation 9.6.12. This value should also agree to three or four significant figures with the value of permeability reported in the output file.

This verifies Functional Requirement R.9. Indirectly, this independent calculation also verifies Functional Requirement R.5, inputting of the initial conditions for brine pressure.

*Klinkenberg effect.*

BRAGFLO calculates the Klinkenberg effect on gas permeability's using the following equation (18):

$$k_g = k_w \left( 1 + \frac{bk_w^a}{p} \right) \quad (9.6.13)$$

where

- $k_g$  = intrinsic permeability to gas [ $\text{m}^2$ ],
- $k_w$  = intrinsic permeability to brine [ $\text{m}^2$ ],
- $a$  = formation-dependent constant,
- $b$  = formation-dependent constant,
- $p$  = gas pressure [Pa].

The constants  $a$  and  $b$  are input as

- $a$  = EXPKLINK,
- $b$  = BKLINK.

The tester should verify that  $a$  and  $b$  are read correctly from input by comparing the values in the input file with the values reported in the output file.

At any time that results are output, in either the ASCII output file or the .CDB file, the tester can select gas pressure (or PRES GAS) and permeability to brine (or PERMBRX) and apply equation 9.6.13. The result should agree to three or four significant figures with the value of permeability to gas (or PERMGAS) reported in the output files. This verifies Functional Requirement R.10. Relative permeability and capillary pressure.

BRAGFLO will use two relative permeability and capillary pressure models in compliance calculations: A modified van Genuchten/Parker model in which the residual gas saturation may be greater than zero (19); and a Brooks-Corey model (20) in which only the non-wetting phase is modified from the original. Both of these models are explicit functions of saturation and are easily verified.

The modified van Genuchten/Parker model ( $KRP = 1$ ) provides relative permeability's and capillary pressures from the following:

$$k_{rw} = S_e^{1/2} \left[ 1 - \left( 1 - S_e^{1/m} \right)^m \right]^2 \quad (9.6.14)$$

$$k_{rg} = \left( 1 - S_{eg} \right)^{1/2} \left( 1 - S_{eg}^{1/m} \right)^{2m} \quad (9.6.15)$$

$$P_c = P_o \left( S_{eg}^{-1/m} - 1 \right)^{1-m} \quad (9.6.16)$$

where the effective brine saturation is



$$S_e = \frac{S_w - S_{wr}}{1 - S_{wr}} \quad (9.6.17)$$

and the effective gas saturation is

$$S_{eg} = \frac{S_w - S_{wr}}{1 - S_{gr} - S_{wr}} \quad (9.6.18)$$

The parameter  $m$  is related to the input parameter  $\lambda = \text{XLAMDA}$  (used in the Brooks-Corey model) by

$$m = \frac{\lambda}{1 + \lambda} \quad (9.6.19)$$

The residual brine saturation is an input parameter,  $S_{wr} = \text{SBR}$ , and the residual gas saturation is an input parameter,  $S_{gr} = \text{SGR}$ .

The pressure constant,  $P_o$ , is evaluated by setting the capillary pressure from the van Genuchten/Parker model equal to the capillary pressure given by the Brooks-Corey model (equation 9.6.26) using an effective saturation for the gas phase of 0.5 in the Brooks-Corey model and an effective saturation for the brine phase in the van Genuchten/Parker model. Then  $P_o$  is given by:

$$P_o = 2^{1/\lambda} P_t (S_{e,vGP}^{-1/m} - 1)^{m-1} \quad (9.6.20)$$

where  $P_t$  = threshold capillary pressure, which is correlated to permeability:

$$P_t = ak^\eta \quad (9.6.21)$$

and  $S_{e,vGP}$  is the effective saturation:

$$S_{e,vGP} = \frac{1 (1 - S_{wr} - S_{gr})}{2 (1 - S_{wr})} \quad (9.6.22)$$

The parameters in this correlation are input as  $a = \text{PCT\_A}$  and  $\eta = \text{PCT\_EXP}$ .

The gas pressure is obtained from the brine pressure,  $P_b$ , and the capillary pressure,  $P_c$ :

$$P_g = P_b + P_c \quad (9.6.23)$$

The tester can take any reported value of brine saturation and brine permeability and perform these calculations. A grid block must be chosen in which the material uses the van Genuchten/Parker modified model,  $\text{KRP} = 1$ . The results should agree to three or four

significant figures with values of relative permeability to brine, relative permeability to gas, and gas pressure reported in the output files.

The modified Brooks-Corey model (KRP = 4) gives relative permeability's and capillary pressures from

$$k_{rw} = S_e^{(2+3\lambda)/\lambda} \quad (9.6.24)$$

$$k_{rg} = (1 - S_e)^2 (1 - S_e^{(2+\lambda)/\lambda}) \quad (9.6.25)$$

$$P_c = \frac{P_t}{S_e^{1/\lambda}}, \quad (9.6.26)$$

where all the parameters are the same as discussed for the van Genuchten/Parker model.

The tester can take any reported value of brine saturation and brine permeability and perform these calculations. A grid block must be chosen in which the material uses the modified Brooks-Corey model, KRP = 4. The results should agree to three or four significant figures with values of relative permeability to brine, relative permeability to gas, and gas pressure reported in the output files. This tests Functional Requirements R.7 and R.8.

#### *Gas density and brine density.*

Gas density is computed using the Redlich-Kwong-Soave (RKS) equation of state. In the compliance calculations, and in Test Case #6, the gas is assumed to be pure hydrogen. For a pure gas, the RKS equation of state has the form (21):

$$P_g = \frac{RT}{V - b} - \frac{a\alpha}{V(V + b)}, \quad (9.6.27)$$

where

$P_g$  = gas pressure [Pa],

$R$  = gas constant = 8.31451 J mol<sup>-1</sup> K<sup>-1</sup>

$T$  = temperature [K]; set in input as TREF = 300.15 K (= 27 °C),

$V$  = molar volume [m<sup>3</sup> mol<sup>-1</sup>],

$a = 0.42747R^2T_c^2 / P_c$ ,

$b = 0.08664RT_c / P_c$ ,

$\alpha = [1 + (0.48508 + 1.55171\omega - 0.15613\omega^2)(1 - T_r^{0.5})]^2$ ,

$\alpha = 1.202\exp(-0.30288T_r)$  for hydrogen (22),

$T_c$  = critical temperature [K],

$P_c$  = critical pressure [Pa],

$T_r = T/T_c$  = reduced temperature,

$\omega$  = acentric factor.

For hydrogen, a pseudo-critical temperature and pressure are used instead of the true values of these properties:

$$T_c = 43.6 \text{ K}$$

$$P_c = 2.047 \times 10^6 \text{ Pa.}$$

BRAGFLO solves equation 9.6.27 for molar volume,  $V$ , and computes the density,  $\rho_g$ , by dividing the molecular weight of hydrogen by  $V$ :

$$\rho_g = M_{w,H_2} / V, \quad (9.6.28)$$

where

$$M_{w,H_2} = \text{molecular weight of hydrogen} = 2.01588 \times 10^{-3} \text{ kg m}^{-3}.$$

The tester should select from the ASCII output file or the .CDB file a gas pressure (PRESGAS) and gas density (DENGAS) at the same time step and same grid block, and calculate  $V$  using equation 9.6.28. Then, evaluate equation 9.6.27. The right hand side of equation 9.6.27 should equal the gas pressure to within independent calculation round-off. This will verify the gas density portion of Functional Requirement R.12.

The pressure dependence of brine density,  $\rho_b$ , is computed in BRAGFLO as follows:

$$\rho_b = \rho_{bo} \exp[C_b(P_b - P_o)], \quad (9.6.29)$$

where

$\rho_b$  = brine density [kg m<sup>-3</sup>]

$\rho_{bo}$  = brine density at reference conditions [kg m<sup>-3</sup>],  
input as DENOSC = 1230.0 kg m<sup>-3</sup>,

$C_b$  = brine compressibility [Pa<sup>-1</sup>],  
input as BRCOMP =  $2.5 \times 10^{-10}$  Pa<sup>-1</sup>,

$P_b$  = brine pressure [Pa],

$P_{bo}$  = brine pressure at reference conditions [Pa],  
input as PREF =  $1.0132 \times 10^5$  Pa.

The tester should select brine pressure at any time step and any grid block from the ASCII output file or the .CDB file and evaluate brine density using equation 9.6.29. The results should agree to within round-off with corresponding brine density value reported in the output files.

These tests verify Functional Requirements R.11 and R.12.

*Borehole material map and properties at human intrusion.*

In Test Case #6, the material map (Functional Requirement R.7) is redefined from the initial map three times: at time zero, which as the time when the repository is sealed is when the actual compliance calculations begin; at 100 years, when the shaft seal properties change; and at 1000 years, when a human intrusion occurs. The last material map change is especially important, because it is nothing more than a material change in certain grid cells that distinguishes a human intrusion scenario simulation from an undisturbed scenario simulation.

To check that this material change has been implemented, the tester must use GROPE to examine the output in BF2\_QB0600\_TEST6.CDB. A complete set of results should be available at 1000 years, immediately before the human intrusion occurs. The next complete set is output 20 time steps later, and certain key parameter values should have changed in grid cells that now make up the human intrusion borehole. An entire column of grid cells ( $J = 15$ ) will have changed, but the most apparent changes will have occurred in cells that were halite prior to the intrusion. Element numbers for this column, as used by GROPE, and the materials in those cells prior to intrusion are listed in Table 9.6.1. Manual inspection of the permeability's of these cells should show that they have changed from the values shown in Table 9.6.1 to a single value for all cells in that column:  $1.65959 \times 10^{-13} \text{ m}^2$ . The porosities should have changed from the values in the table to a single value for the entire column of 0.37. The compressibility of the borehole material is input as zero, so the borehole porosity is unaffected by pressure and should remain 0.37 for the full length for the duration of the run. These checks help to verify Functional Requirement R.7.

**TABLE 9.6.1 GRID CELL NUMBERS USED IN  
 BF2\_QB0600\_TEST6.CDB: FOR THE HUMAN INTRUSION  
 BOREHOLE, AND MATERIALS IN THOSE CELLS PRIOR TO  
 INTRUSION**

<b>Borehole material map and properties at human intrusion</b>					
<b>Row No. (ELEMENTS)</b>	<b>Element No. in BF2_TEST6.CDB</b>	<b>Permeability (PERMBRX) prior to intrusion, 972.8 yr, step 646, m<sup>2</sup></b>	<b>Permeability (PERMBRX) after intrusion, at 1000.06 yr, step 666, m<sup>2</sup></b>	<b>Porosity (POROS) prior to intrusion</b>	<b>Porosity (POROS) after intrusion</b>
1	819	1.33045E-11	1.65959E-13	0.00520	0.37
2	790	0.00000E+00	1.65959E-13	0.00520	0.37
3	11	1.31826E-24	1.65959E-13	0.02256	0.37
4	42	1.31826E-24	1.65959E-13	0.02256	0.37
5	73	1.31826E-24	1.65959E-13	0.02256	0.37
6	301	1.00000E-15	1.65959E-13	0.02506	0.37
7	315	1.00000E-15	1.65959E-13	0.02506	0.37
8	439	5.58470E-12	1.65959E-13	0.23843	0.37
9	446	5.58470E-12	1.65959E-13	2.38426	0.37
10	453	5.58470E-12	1.65959E-13	0.23842	0.37
11	333	1.00000E-15	1.65959E-13	0.02513	0.37
12	347	1.00000E-15	1.65959E-13	0.02515	0.37
13	365	1.00000E-15	1.65959E-13	0.02520	0.37
14	416	1.88979E-14	1.65959E-13	0.04401	0.37
15	188	1.31826E-24	1.65959E-13	0.02257	0.37
16	209	1.31826E-24	1.65959E-13	0.02256	0.37
17	230	1.31826E-24	1.65959E-13	0.02256	0.37
18	251	1.31826E-24	1.65959E-13	0.02256	0.37
19	516	0.00000E+00	1.65959E-13	0.20000	0.37
20	546	2.64850E-13	1.65959E-13	0.14600	0.37
21	576	0.00000E+00	1.65959E-13	0.20000	0.37
22	606	1.09648E-16	1.65959E-13	0.09000	0.37
23	636	0.00000E+00	1.65959E-13	0.20000	0.37
24	666	9.33255E-16	1.65959E-13	0.14969	0.37
25	696	9.33255E-16	1.65959E-13	0.15000	0.37
26	726	1.00000E-10	1.65959E-13	0.17500	0.37
27	756	1.00000E-10	1.65959E-13	0.17500	0.37

*Porosity in non-closure and non-fractured materials.*

The porosity in all materials except those that undergo creep closure or fracturing is computed using a constant rock compressibility,  $C_r$  [ $\text{Pa}^{-1}$ ], input as CROCK:

$$\phi = \phi_o \exp[C_r(p - p_o)], \quad (9.6.30)$$

where  $\phi_o$  is the porosity at the reference pressure,  $p_o$ , and  $p$  is the brine pressure [Pa]. The reference porosity is input for each material. The reference pressure is the initial pressure in each grid block.

The tester should select at any time step any grid block in a material that is not undergoing creep closure or fracturing at that time. The initial, or reference, pressure must be obtained from the input file. The reference porosity and rock compressibility for the material in the grid block selected should be obtained either from the input file or from the ASCII output file where input material properties are echoed. Then, use equation 9.6.30 to evaluate the porosity in the grid block selected. The resulting value should agree to three or four significant figures with the value of porosity reported in the ASCII output file or as POROS in the .CDB file. This will verify Functional Requirement R.7, that material porosities and compressibility's have been input and used correctly for a material in which fracturing and creep closure are not occurring.

*Reading PREBRAG input.*

The input file used in Test Case #6 was prepared using PREBRAG. The acceptance criterion for Functional Requirement R.18 is **manual inspection** of the output, which should agree, to the number of digits reported, with the same parameters in the input file. The comparison also tests Requirement R.25 that BRAGFLO successfully reads the PREBRAG output file.

*Post-processing using POSTBRAG.*

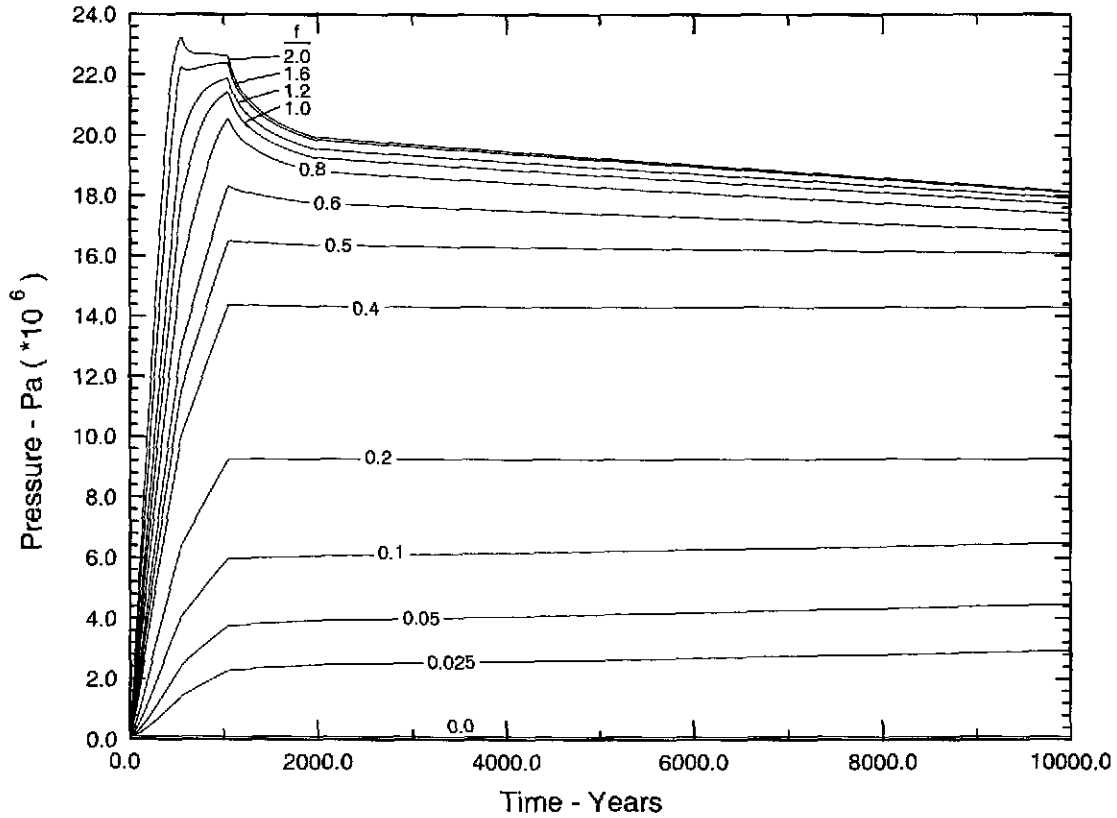
The binary output file in Test Case #6 should be post-processed using POSTBRAG. The acceptance criterion for External Interface Requirement R.27 is manual inspection of the output in BF2\_QB0600\_TEST6.CDB using GROPE. The values in the .CDB file should agree, to the number of digits reported, with the values reported in the ASCII output file. Because interblock brine flows read from the output .CDB file play important roles in other codes (NUTS, in particular), values of these variables in the .CDB file should be checked to verify that they are the same as the values reported in the ASCII output file.

**FIGURE 9.6.1A POROSITY SURFACE USED IN BRAGFLO FOR WASTE WITHOUT BACKFILL; PRESSURE VS TIME; TIME SCALE 0-10,000 YEARS.**

(a) Given time and pressure, interpolate in this figure to obtain  $f$ -value. (b) Given time and  $f$ -value from this figure, obtain porosity from Figure 9.6.3(b).

(page 1 of 4)

Brine Pressure - Surface #4 (Waste w/o Backfill)



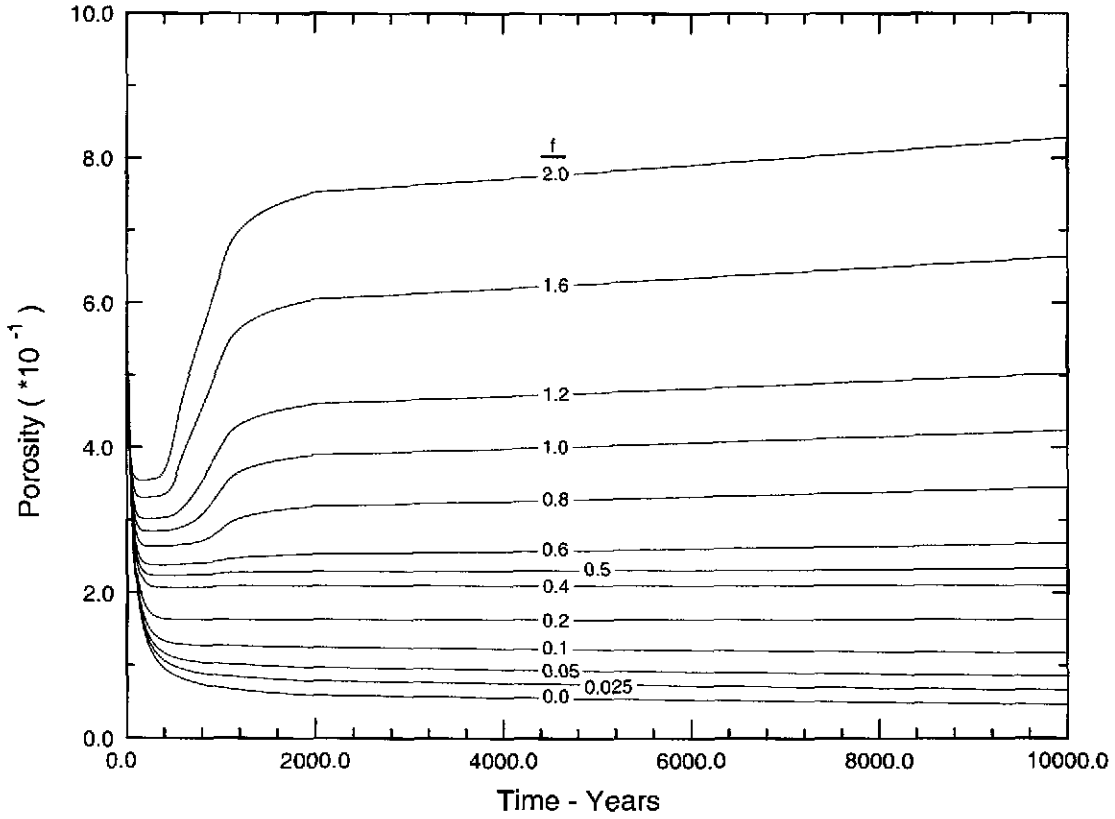
U1:\JDSCHRE.BRAGFLO.SURFACE\_96\BF2\_PORSURF4.CMD;1

SPLAT X2.0 03/04/96 16:02:58

**FIGURE 9.6.1B POROSITY SURFACE USED IN BRAGFLO FOR WASTE WITHOUT BACKFILL; POROSITY VS TIME; TIME SCALE 0-10,000 YEARS.**  
(a) Given time and pressure, interpolate in Figure 9.6.3(a) to obtain  $f$ -value.  
(b) Given time and  $f$ -value from 9.6.3(a), obtain porosity from this figure.

(page 2 of 4)

Waste Porosity - Surface #4 (Waste w/o Backfill)



U1:(JDSCHRE.BRAGFLO.SURFACE\_96)BF2\_PORSURF4.CMD:1

SPLAT X2.0 03/04/96 16:03:08

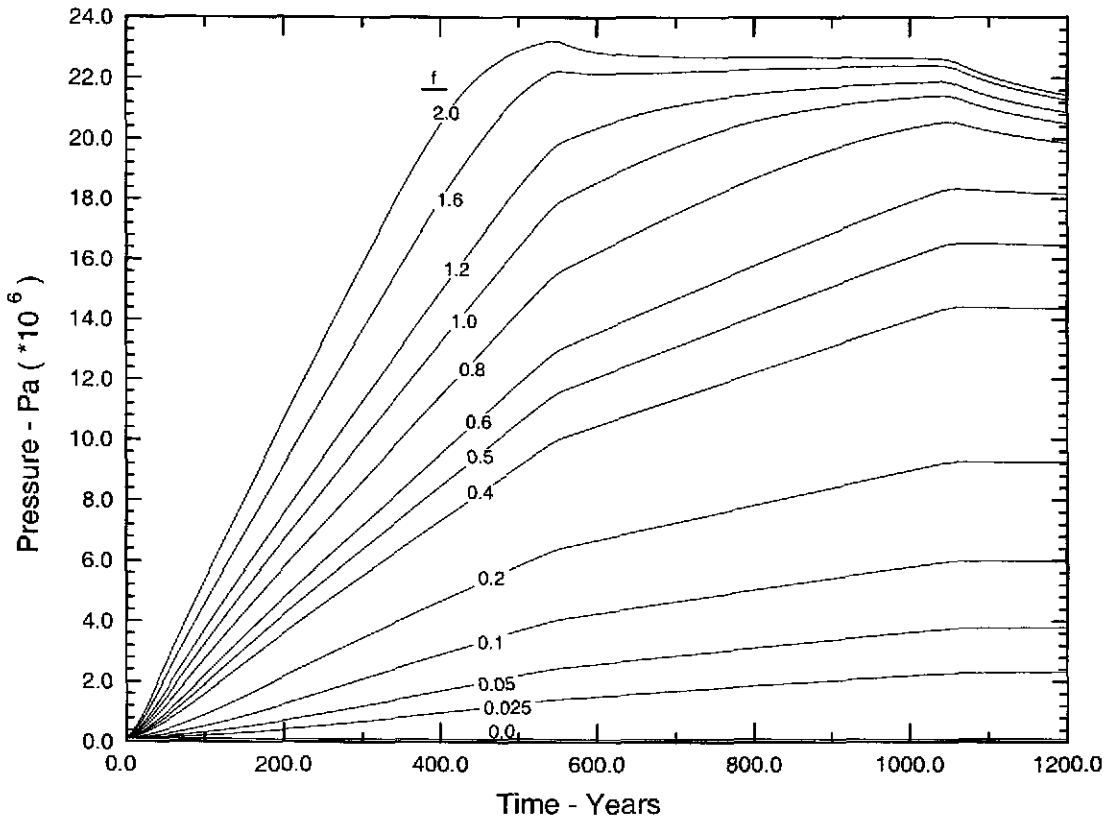


**FIGURE 9.6.2A POROSITY SURFACE USED IN BRAGFLO FOR WASTE WITHOUT BACKFILL; PRESSURE VS TIME; TIME SCALE 0-1200 YEARS.**

- (a) Given time and pressure, interpolate in this figure to obtain  $f$ -value.
- (b) Given time and  $f$ -value from this figure, obtain porosity from 9.6.3(d).

(page 3 of 4)

Brine Pressure - Surface #4 (Waste w/o Backfill)



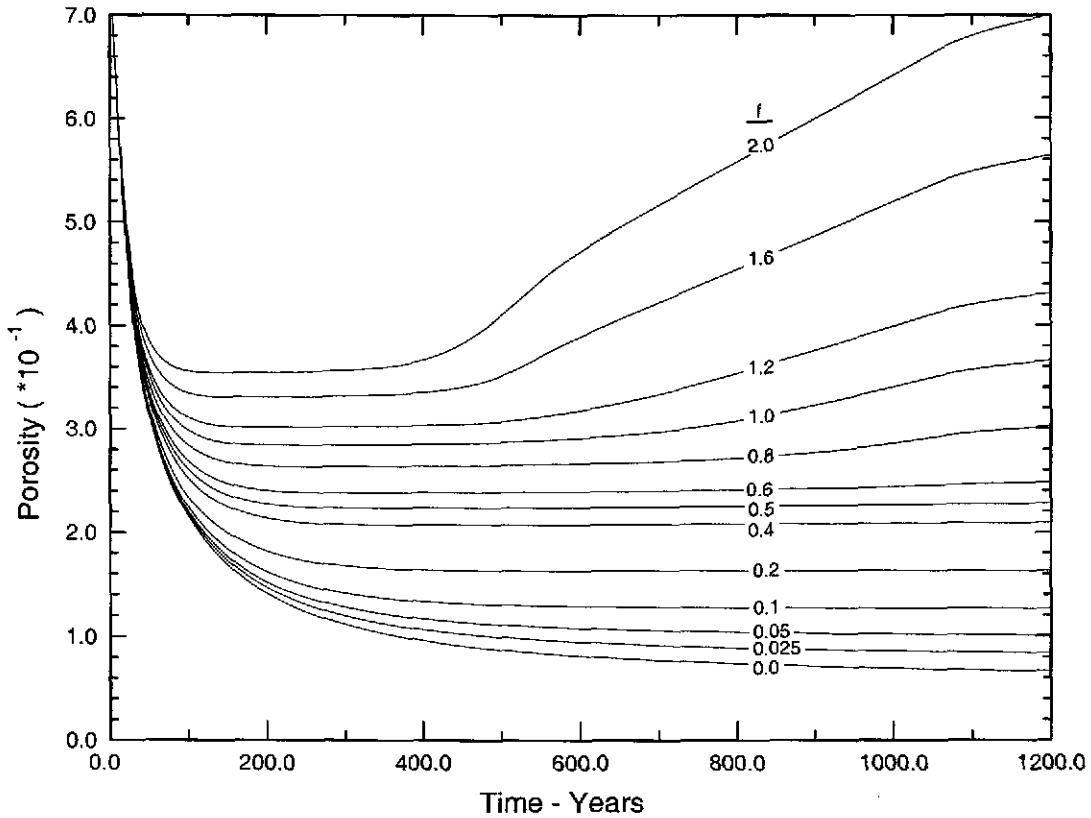
U1:\JDSCHRE BRAGFLO.SURFACE\_96\BF2\_PORSURF4\_1200.CMD;1

SPLAT X2.0 03/04/96 16:03:59

**FIGURE 9.6.2B POROSITY SURFACE USED IN BRAGFLO FOR WASTE WITHOUT BACKFILL; POROSITY VS TIME; TIME SCALE 0-1200 YEARS.**  
(a) Given time and pressure, interpolate in Figure 9.6.3(c) to obtain  $f$ -value.  
(b) Given time and  $f$ -value from 9.6.3(c), obtain porosity from this figure.

(page 4 of 4)

Waste Porosity - Surface #4 (Waste w/o Backfill)



U1:\JDSCHRE\BRAGFLO.SURFACE\_96\BF2\_PORSURF4\_1200.CMD;1

SPLAT X2.0 03/04/96 16:04:08

## **9.7 Test Case #7. FEP baseline calculations, E1 scenario. Total of 20 BRAGFLO runs**

### **9.7.1 Test Objective**

The purpose of this test is to verify that BRAGFLO can simulate the performance of the WIPP site using wide ranges of the parameters that will likely be varied in a compliance calculation. All of the features that are expected to be used in compliance calculations will be exercised in each run. Thus, Functional Requirements R.1 through R.15 and R.18 are tested, with the objective being simply to show, when all features are activated, that the results are reasonable. This is in contrast to other test cases in which certain output variables are examined in detail. The test consists of 20 separate BRAGFLO runs, a complete set from a Latin hypercube sampling (LHS). Each run simulates the behavior of the WIPP site over a 10,000-year period, with a human intrusion occurring at 1000 years, the E1 scenario.

Also, the independent verification of BRAGFLO calculations will confirm that BRAGFLO has read the PREBRAG and closure surface input files (R.25 and R.26). Test Case #7 also requires post-processing the BRAGFLO results from 20 vectors so that SPLAT plots can be produced. This tests Requirement, R.27.

### **9.7.2 Test Procedure**

The BRAGFLO validation tests are run using the WIPP PA run control system. The scripts and script input files that run the validation tests are stored in CMS. All test inputs are fetched at run time by the scripts. All test outputs/results and run logs are stored in CMS by the scripts in class QB0600 of the CMS library, WP\$CMSROOT:[BF]. Other files related to the validation of BRAGFLO 6.0 are submitted for storage in CMS by the SCMS Librarian and reside in QB0600 class of the CMS library.

The resulting binary output files (BF2\_QB0600\_TEST7\_Vxxx.BIN, where xxx = 001 to 020) are post-processed using POSTBRAG and files BF2\_QB0600\_TEST7\_ALGEBRA\_Vxxx.CDB, which are the input .CDB files for POSTBRAG. Post-processing produces 20 output .CDB files named BF2\_QB0600\_TEST7\_Vxxx.CDB. These files can be analyzed individually. However, for this test, the objective is to examine global behavior for all 20 realizations in the LHS. To do this, SUMMARIZE is run to extract the results specified in the SUMMARIZE input file, BF2\_QB0600\_TEST7\_SUMMARIZE.INP, which will be stored in CMS by the scripts in class QB0600 of the CMS library. Twenty data files are generated for SPLAT: BF2\_QB0600\_TEST\_Vxxx.TBL. When SPLAT is run, a set of plots is produced with results from all 20 realizations on each plot. As currently set up, the following results are plotted: gas pressure, gas saturation, porosity, iron concentration, cellulose concentration, and brine phase permeability in the x-direction. One set is produced for Element 458 [bottom center grid block in Rest of Repository, grid block (17,8,1)], and another set for Element 398 [anhydrite layer A and B, just south of DRZ, grid block (8,13,1)]. These are selected as representative of elements where useful information for testing might be obtained. The iron and cellulose concentration for element 398 are not included because this element is not in a waste region so the concentrations will be identically zero at all times. However, the tester can modify

BF2\_QB0600\_TEST7\_SUMMARIZE.INP and BF2\_QB0600\_TEST7\_SPLAT.CMD to generate plots in any elements of any element variables in the .CDB files.

### 9.7.3 Input Files

The BRAGFLO input files for Test Case #7 are called BF2\_QB0600\_TEST7\_Vxxx.INP (xxx = 001 to 020) and BF2\_CLOSURE.DAT. Additional parameters have been added to the input files to suppress the new models added to BRAGFLO 6.0 compared with BRAGFLO 5.0. Otherwise, the input files, BF2\_QB0600\_TEST7\_Vxxx.INP (xxx = 001 to 020), are identical to BF2\_QA0500\_TEST7\_Vxxx.INP (xxx = 001 to 020), which are the input files for Test Case #7 in the validation of BRAGFLO 5.0. The format of each input file is identical to that in Test Case #6; only the values of certain parameters differ in each. The input file for Test Case #6 is essentially the same as BF2\_QB0600\_TEST7\_V007.INP in Test Case #7, except that biodegradation and corrosion rate constants differ and more extensive output is called for in BF2\_QB0600\_TEST6.INP.

### 9.7.4 Acceptance Criteria

The acceptance criterion used for this test is manual inspection of the results to ensure that the behavior displayed is realistic and reasonable. A detailed examination of every number output, along the lines of Test Case #6, is neither practical nor necessary. The objective is simply to ensure that the results make sense when parameters that will be varied in compliance calculations are varied over wide ranges. Gas pressures (PRESGAS in the .CDB file), for example, should be positive everywhere and bounded within reasonable limits (say, 30 MPa). In the waste and other excavated regions, the pressures should start at atmospheric and increase over time, generally ending up, at 10,000 years between 6 MPa and 15 MPa (or approximately between hydrostatic to lithostatic pressures). Saturations (SATGAS) everywhere should be between 0 and 1. Porosities (POROS) everywhere should be between 0 and 1. In the waste, porosities should start at 88% and decrease rapidly; providing creep closure is in effect for the full duration of the run, the porosities in the waste should never drop below 4.6%, which is the minimum porosity in the porosity surface to be used in the compliance calculations. Concentrations of reactants (iron and celluloses, or FECONC and CELLCONC) should decrease monotonically from their initial values and never be less than zero. Permeability's (PERMBRX) should remain fixed for all time in all materials except for those that undergo fracturing, namely, the three anhydrite layers. In those materials, the permeability's should be bounded by the intact permeability and the maximum permeability allowed by input parameters:  $k_{max} = k_i(\phi_a - \phi_o)^n$ , where the parameters are discussed under equation 9.6.12 of Test Case #6.

Functional Requirements R.1 through R.15 and R.18 will be successfully tested if all results are reasonable and explainable, then the objective of this test case has been met. In addition, all three external interface requirement are confirmed by the successful completion of Test Case #6, which requires reading a PREBRAG output file and post-processing with POSTBRAG.

## 9.8 Test Case #8. Well Production at Specified Bottom Hole Pressure

### 9.8.1 Test Objective

The purpose of this test is to verify that BRAGFLO can simulate the performance of production wells in which the bottom hole pressure is specified, in particular when two phases are present. This type of well model is often used in BRAGFLO to maintain a constant pressure at some location. Dirichlet boundary conditions can achieve the same result somewhat more rigorously. However, the well model has the advantage that conditions can be changed during the course of a run, whereas the Dirichlet conditions are fixed for the entire run. In addition, the outflows, or production from the well, is calculated and can be output, something not done when the Dirichlet conditions are used.

The well model in BRAGFLO treats well deliverability by the inflow performance equation:

$$q_l = I \left( \frac{k_{rl}}{\mu_l} \right) (p_l - p_{wf}) \quad (9.8.1)$$

where

$$\begin{aligned} q &= \text{volumetric flow rate [m}^3/\text{s]}, \\ I &= \text{well productivity index [m}^3\text{]}, \\ k_r &= \text{relative permeability [-]}, \\ \mu &= \text{viscosity [Pa}\cdot\text{s]}, \\ p &= \text{pressure [Pa]}, \end{aligned}$$

and subscripts

$$\begin{aligned} l &= \text{phase (brine or gas)}, \\ wf &= \text{flowing bottom hole}. \end{aligned}$$

To test the BRAGFLO treatment of well production at specified bottom hole pressure, a test was designed and the BRAGFLO results are compared with the results obtained from the code TOUGH28W, which is the WIPP version of the TOUGH code (12).

The test problem considers a horizontal one-dimensional reservoir with two grid blocks. Each grid block is a 10 m cube. Both grid blocks are initially at pressure 10 MPa and water saturation 0.5. Fluids consist of pure water and hydrogen gas. A single well with productivity index of  $1.0 \times 10^{-12} \text{ m}^3$  is completed in the first grid block at initial time and is produced for 1000 s at a fixed flowing bottom hole pressure of 1.0 MPa. The well will produce both water and gas with declining rates as the reservoir is depleted and the pressure decreases. Formation properties are:

$$\begin{aligned} \text{permeability} &= 1.0 \times 10^{-13} \text{ m}^2, \\ \text{porosity} &= 0.5, \\ \text{rock compressibility} &= 0.0 \text{ Pa}^{-1}, \\ \text{capillary pressure} &= 0.0 \text{ Pa}. \end{aligned}$$

Relative permeability's are given by the Brooks-Corey model ( $KRP = 4$ ) with pore distribution parameter  $\lambda = 0.7$  and residual water and gas saturations of zero.

Results from TOUGH28W are shown in Figures 9.8.1 to 9.8.3. Both water and gas are produced from the well grid block (grid block #1). As pressure is depleted from the well block, supporting flow from the second grid block occurs. Both grid blocks become depleted, but the well block maintains a pressure below the adjacent grid block, as shown in Figure 9.8.1. As the pressure declines, both the water and gas production rates (Figures 9.8.2 and 9.8.3, respectively) decline. Tabulated results from TOUGH28W are shown in Table 9.8.1.

Some differences exist between BRAGFLO and TOUGH28W that cannot be compensated for with input data. Fluid properties are represented differently. BRAGFLO uses a constant brine compressibility to compute brine density whereas TOUGH28W uses an equation of state for brine density. It was estimated from TOUGH28W brine density data that the equivalent brine compressibility to use in BRAGFLO was  $4.45 \times 10^{-10} \text{ Pa}^{-1}$ . Fluid viscosity in TOUGH28W is pressure-dependent, whereas BRAGFLO uses constant water and gas viscosity,  $8.5 \times 10^{-2} \text{ Pa}\cdot\text{s}$  and  $8.92 \times 10^{-6} \text{ Pa}\cdot\text{s}$ , respectively. These values were chosen as representative of the values used in TOUGH28W throughout the pressure range encountered. The two codes also implement a different technique for averaging interblock flows, which will contribute to differences in the calculated fluid flows.

This test case tests Functional Requirement R.16 and R.18.

### 9.8.2 Test Procedure

The BRAGFLO validation tests are run using the WIPP PA run control system. The scripts and script input files that run the validation tests are stored in CMS. All test inputs are fetched at run time by the scripts. All test outputs/results and run logs are stored in CMS by the scripts in class QB0600 of the CMS library,  $WP\$CMSROOT:[BF]$ . Other files related to the validation of BRAGFLO 6.0 are submitted for storage in CMS by the SCMS Librarian and reside in QB0600 class of the CMS library.

The Fortran code,  $BF2\_TEST8\_POST.FOR$ , was used in the validation of BRAGFLO 4.10. It may need to be modified to accommodate additional information in the ASCII output file,  $BF2\_QB0600\_TEST8.OUT$  for BRAGFLO 6.0, but all files and code used in the validation will be stored in CMS class QB0600. The executable file of the Fortran code is run to extract pressures, saturations, and time-average well flow rates of water and gas from the ASCII output file,  $BF2\_QB0600\_TEST8.OUT$ , and place this information into files used by the plotting package, SPLAT. SPLAT reproduces Figures 9.8.1, 9.8.2, and 9.8.3, and the BRAGFLO results are superimposed for comparison.

### 9.8.3 Input Files

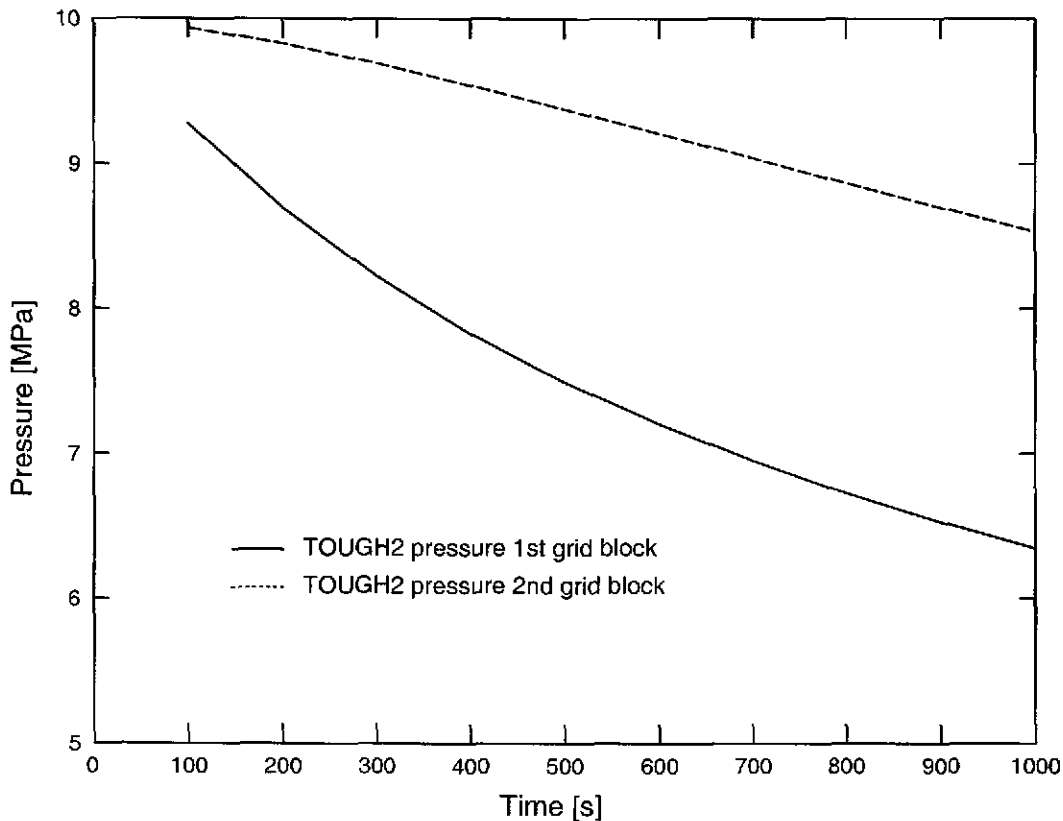
The BRAGFLO input files for Test Case #8 are called  $BF2\_QB0600\_TEST8.INP$  and  $BF2\_CLOSURE.DAT$ . Additional parameters have been added to the input file to suppress the

new models added to BRAGFLO 6.0 compared with BRAGFLO 5.0. Otherwise, the input file, BF2\_QB0600\_TEST8.INP, is identical to BF2\_QA0500\_TEST8.INP, which is the input file for Test Case #8 in the validation of BRAGFLO 5.0.

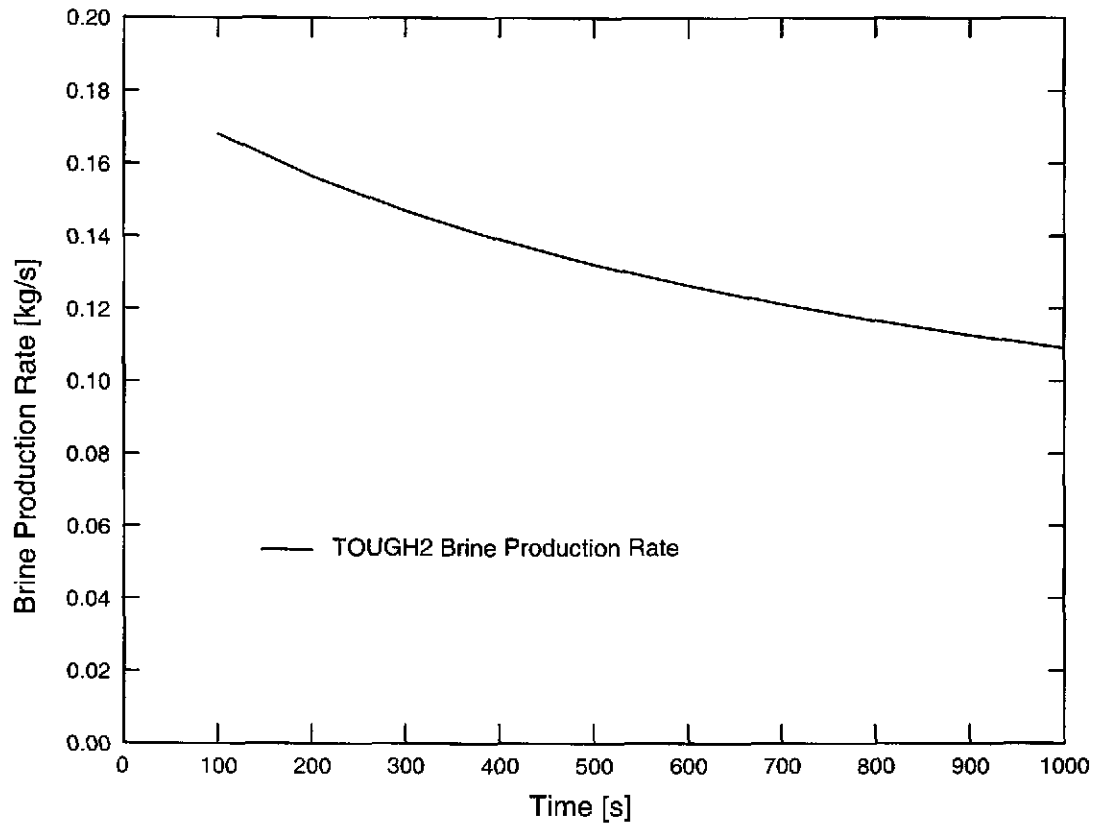
### 9.8.4 Acceptance Criteria

The acceptance criteria used for this test are comparisons with other independently developed software of similar purpose (i.e., TOUGH), and manual inspection of the results to ensure that the behavior displayed is realistic and reasonable. Despite the differences between BRAGFLO and TOUGH28W described above, BRAGFLO results for a simple problem such as this test case should differ from TOUGH results tabulated in Table 9.8.1 by less than 10%. In particular, the qualitative behavior shown in the results should be identical. Both water and gas should be produced from the well grid block (grid block #1), accompanied by flow from the second grid block, reducing the pressure in both grid blocks. The well block should maintain a pressure below the adjacent grid block, as shown for TOUGH28W in Figure 9.8.1. As the pressure declines, both the water and gas production rates (Figures 9.8.2 and 9.8.3, respectively) should decline. This verifies Functional Requirement R.16 and R.18.

**FIGURE 9.8.1 RESULTS FROM TOUGH28W RUN ON TEST CASE #8.  
RESERVOIR PRESSURE RESPONSE FOR PRESSURE-SPECIFIED  
DELIVERABILITY**

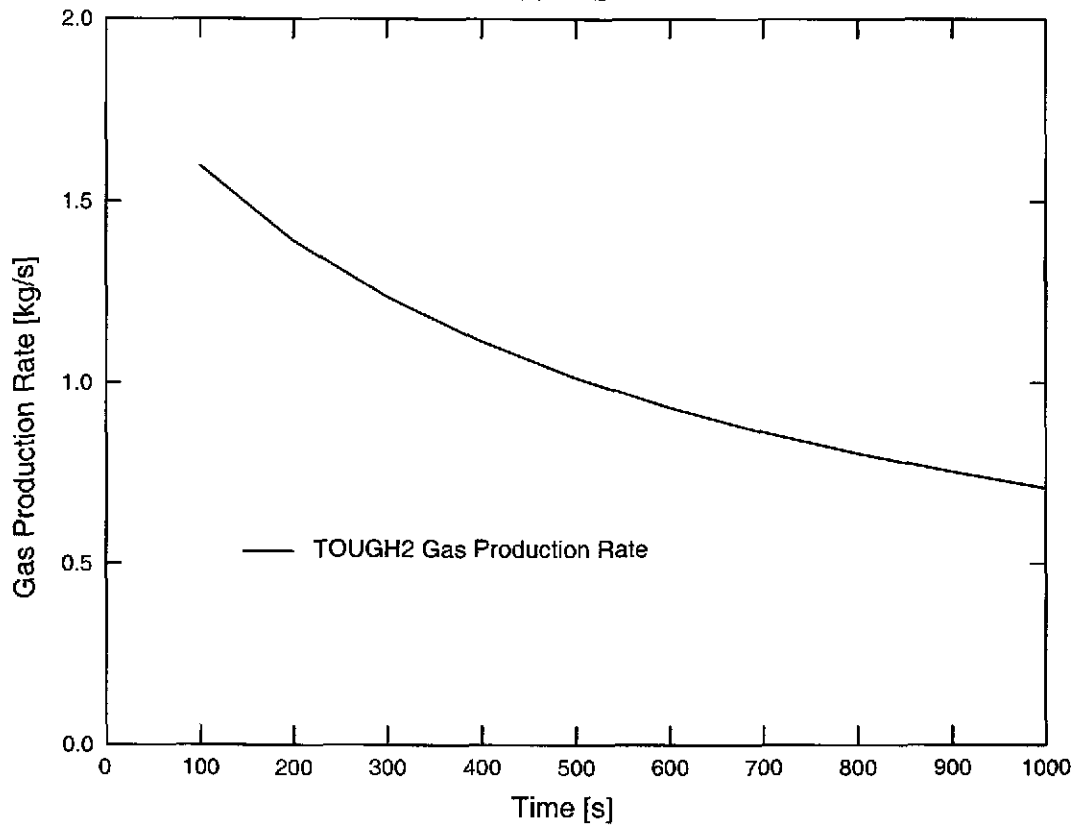


**FIGURE 9.8.2 RESULTS FROM TOUGH28W RUN ON TEST CASE #8.  
BRINE PRODUCTION RATE FOR PRESSURE-SPECIFIED DELIVERABILITY**





**FIGURE 9.8.3 RESULTS FROM TOUGH28W RUN ON TEST CASE #8. GAS PRODUCTION RATE FOR PRESSURE-SPECIFIED DELIVERABILITY**



**TABLE 9.8.1 RESULTS FROM TOUGH28W RUN ON TEST CASE  
#8. BF2\_TEST8\_TOUGH.DAT**

<b>Time yr</b>	<b>Pressure block 1 MPa</b>	<b>Pressure block 2 MPa</b>	<b>Brine Production Rate kg/s</b>	<b>Gas Production Rate kg/s</b>
1000	9.279	9.936	0.1682	1.597
2000	8.700	9.829	0.1566	1.393
3000	8.226	9.694	0.1471	1.237
4000	7.831	9.542	0.1391	1.114
5000	7.494	9.380	0.1323	1.014
6000	7.205	9.211	0.1265	0.9314
7000	6.951	9.040	0.1213	0.8623
8000	6.727	8.869	0.1168	0.8034
9000	6.526	8.700	0.1127	0.7523
10000	6.345	8.533	0.1091	0.7076

## 9.9 Test Case #9. Heterogeneous Reservoir Conditions

### 9.9.1 Test Objective

The purpose of this test is to verify that BRAGFLO can simulate fluid flow in a non-uniform formation, in particular, where the permeability is non-uniform. Test Case #9 considers the following one-dimensional steady-state single phase flow problem. A 1-D reservoir is discretized with 15 uniform grid blocks of 1 m dimension in each coordinate direction. An injection well is located in the first (left-most) grid block with water injection rate of 0.1 kg/s. In the 15th (right-most) grid block, a well produces water at a rate of 0.1 kg/s. At the initial time, the water pressure within the reservoir is a uniform 1.0 MPa. When steady-state flow is achieved in the reservoir, the velocity must satisfy

$$v_w = -\left(\frac{k}{\mu_w}\right)\frac{dp}{dx} = \frac{q_{inj}}{\rho_w A} \quad (9.9.1)$$

where

$$\begin{aligned} v_w &= \text{Darcy velocity [m/s]}, \\ k &= \text{formation permeability [m}^2\text{]}, \\ \mu_w &= \text{water viscosity, 0.001 [Pa}\cdot\text{s]}, \\ dp/dx &= \text{pressure gradient in } x\text{-direction [Pa/m]}, \\ q_{inj} &= \text{water injection rate, 0.1 [kg/s]}, \\ \rho_w &= \text{water density, 1000 [kg/m}^3\text{]}, \\ A &= \text{area normal to flow, 1.0 [m}^2\text{]}. \end{aligned}$$

First consider the case with uniform formation property:

$$k = 1.0 \times 10^{-11} \text{ m}^2 \quad (9.9.2)$$

The pressure gradient is then determined by

$$\frac{dp}{dx} = -\left(\frac{\mu_w}{k}\right)\frac{q_{inj}}{\rho_w A} \quad (9.9.3)$$

For the above parameter values,

$$\frac{dp}{dx} = -1.0 \times 10^4 \text{ Pa/m} \quad (9.9.4)$$

If the reservoir is allowed to equilibrate over time to a steady state condition, then the pressure at the center of the reservoir (center of grid block 8) will maintain 1.0 MPa pressure, and the pressure gradient within the reservoir will assume the value  $-1.0 \times 10^4$  Pa/m. When BRAGFLO is run to steady state condition ( $1.0 \times 10^5$  s), the results should be the linear pressure profile shown in Figure 9.9.1.

Now introduce formation heterogeneity. Within the grid, the permeability is assigned as:

$$\begin{aligned}k &= 0.25 \times 10^{-11} \text{ m}^2, \text{ for } 0 < x < 5, \\k &= 1.00 \times 10^{-11} \text{ m}^2, \text{ for } 5 < x < 10, \\k &= 0.25 \times 10^{-11} \text{ m}^2, \text{ for } 10 < x < 15.\end{aligned}\tag{9.9.5}$$

This choice of permeability distribution maintains symmetry about the center of the reservoir. The resulting pressure gradients are:

$$\begin{aligned}dp/dx &= -4.0 \times 10^4 \text{ Pa/m}, \text{ for } 0 < x < 5, \\dp/dx &= -1.0 \times 10^4 \text{ Pa/m}, \text{ for } 5 < x < 10, \\dp/dx &= -4.0 \times 10^4 \text{ Pa/m}, \text{ for } 10 < x < 15.\end{aligned}\tag{9.9.6}$$

The steady state solution will maintain 1.0 MPa pressure at the grid center and will honor the above pressure gradients, as shown in Figure 9.9.2. The exact solutions for the homogeneous and heterogeneous problems are tabulated in Table 9.9.1.

This test case tests Functional Requirement R.17. The numerical output also tests Functional Requirement R.18

### 9.9.2 Test Procedure

The BRAGFLO validation tests are run using the WIPP PA run control system. The scripts and script input files that run the validation tests are stored in CMS. All test inputs are fetched at run time by the scripts. All test outputs/results and run logs are stored in CMS by the scripts in class QB0600 of the CMS library, WP\$CMSROOT:[BF]. Other files related to the validation of BRAGFLO 6.0 are submitted for storage in CMS by the SCMS Librarian and reside in QB0600 class of the CMS library.

The Fortran codes, BF2\_TEST9\_HOMOG\_POST.FOR and BF2\_TEST9\_HETER\_POST.FOR, were used in the validation of BRAGFLO 4.10. They may need to be modified to accommodate additional information in the ASCII output files, BF2\_QB0600\_TEST9\_HOMOG.OUT and BF2\_QB0600\_TEST9\_HETER.OUT, from BRAGFLO 6.0, but all files and code used in the validation will be stored in CMS class QB0600. The executable file of the Fortran code is run to extract water (brine) pressures and place this information into files used by the plotting package, SPLAT. SPLAT reproduces Figures 9.9.1 and 9.9.2 with BRAGFLO results superimposed.

### 9.9.3 Input Files

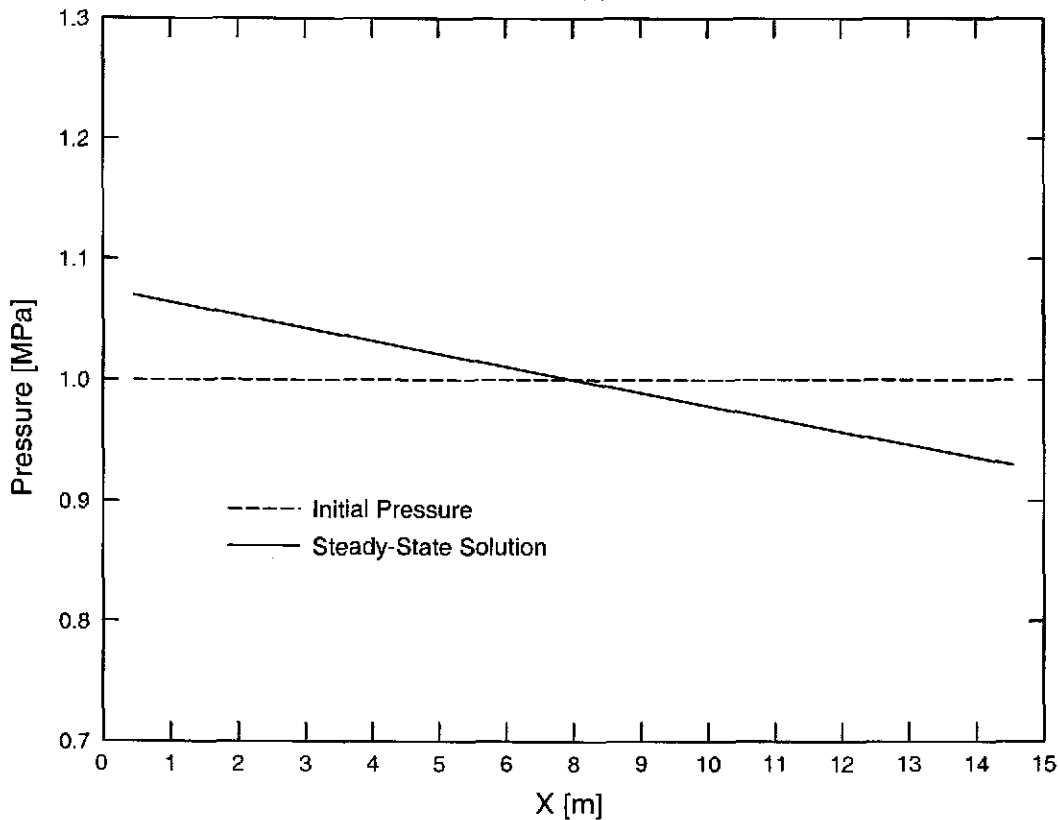
The BRAGFLO input files for Test Case #9 are called BF2\_QB0600\_TEST9\_HOMOG.INP, BF2\_QB0600\_TEST9\_HETER.INP, and BF2\_CLOSURE.DAT. Additional parameters have been added to the input files to suppress the new models added to BRAGFLO 6.0 compared with BRAGFLO 5.0. Otherwise, the input files, BF2\_QB0600\_TEST9\_HOMOG.INP, BF2\_QB0600\_TEST9\_HETER.INP, are identical to BF2\_QA0500\_TEST9\_HOMOG.INP,

BF2\_QA0500\_TEST9\_HETER.INP, which is the input file for Test Case #9 in the validation of BRAGFLO 5.0.

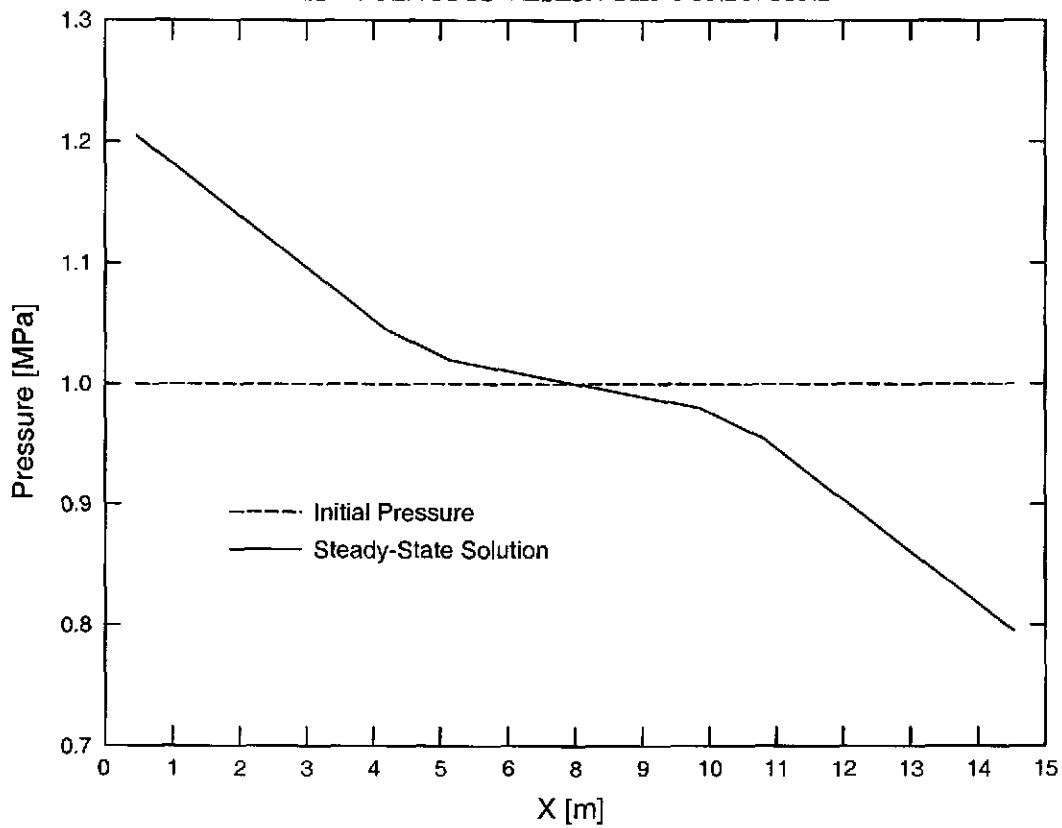
### 9.9.4 Acceptance Criteria

The acceptance criteria used for this test are comparisons with analytical solutions. BRAGFLO results for a simple problem such as this test case should differ from the analytical solutions tabulated in Table 9.9.1 by less than 10%. This will verify Functional Requirements R.17 and R.18.

**FIGURE 9.9.1 STEADY-STATE SOLUTION FOR TEST CASE #9,  
HOMOGENEOUS RESERVOIR CONDITIONS**



**FIGURE 9.9.2 STEADY-STATE SOLUTION FOR TEST CASE #9,  
HETEROGENEOUS RESERVOIR CONDITIONS**



**TABLE 9.9.1 ANALYTICAL STEADY-STATE SOLUTIONS FOR TEST CASE #9. HOMOGENEOUS RESERVOIR CONDITIONS**

<b>x, m</b>	<b>Steady-State Analytical Solution Pressure, MPa</b>	<b>Initial Pressure, MPa</b>
0.5	1.070000	1.000000
1.5	1.060000	1.000000
2.5	1.050000	1.000000
3.5	1.040000	1.000000
4.5	1.030000	1.000000
5.5	1.020000	1.000000
6.5	1.010000	1.000000
7.5	1.000000	1.000000
8.5	0.990000	1.000000
9.5	0.980000	1.000000
10.5	0.970000	1.000000
11.5	0.960000	1.000000
12.5	0.950000	1.000000
13.5	0.940000	1.000000
14.5	0.930000	1.000000

**Heterogeneous Reservoir Conditions**

<b>x, m</b>	<b>Steady-State Analytical Solution Pressure, MPa</b>	<b>Initial Pressure, MPa</b>
0.5	1.205000	1.000000
1.5	1.165000	1.000000
2.5	1.125000	1.000000
3.5	1.085000	1.000000
4.5	1.045000	1.000000
5.5	1.020000	1.000000
6.5	1.010000	1.000000
7.5	1.000000	1.000000
8.5	0.990000	1.000000
9.5	0.980000	1.000000
10.5	0.955000	1.000000
11.5	0.915000	1.000000
12.5	0.875000	1.000000
13.5	0.835000	1.000000
14.5	0.795000	1.000000

## 9.10 Test Case #10. No Flow Boundary Conditions

### 9.10.1 Test Objective

The purpose of this test is to verify that the default no flow boundary conditions are implemented correctly by comparing BRAGFLO results with an analytical solution for a problem that incorporates a no flow boundary. This is a test of Functional Requirement R.4 and R.18.

The problem is a well drawdown in a finite radial reservoir. After the transient period the pressure front will reach the boundary after which time a semi-steady state drawdown will occur. The analytical solution is obtained from the solution of the radial diffusivity equation with constant production rate at the well and a no flow condition at the reservoir exterior boundary (23). The analytical solution for the wellbore pressure drawdown is

$$P - P_{wf} = \left( \frac{q\mu}{2\pi kh} \right) \left[ \ln \left( \frac{r}{r_w} \right) - \frac{r^2}{2r_e^2} + \frac{r_w^2}{2r_e^2} \right] \quad (9.10.1)$$

where

- $P$  = reservoir pressure [Pa],
- $P_{wf}$  = wellbore flowing pressure [Pa],
- $q$  = well rate [ $\text{m}^3/\text{s}$ ],
- $\mu$  = water viscosity [Pa s],
- $k$  = formation permeability [ $\text{m}^2$ ],
- $h$  = formation thickness [m],
- $r$  = radius [m],
- $r_w$  = well bore radius [m],
- $r_e$  = exterior radius to outer boundary [m].

Parameters for this study were taken to be

- $q = 0.001 \text{ m}^3/\text{s}$  (for BRAGFLO,  $q = 1.0 \text{ kg/s}$ , since  $\rho_w = 1000 \text{ kg/m}^3$ ),
- $\mu = 1.8 \times 10^{-3} \text{ Pa s}$ ,
- $k = 1.8 \times 10^{-12} \text{ m}^2$ ,
- $h = 1.0 \text{ m}$ ,
- $r_w = 0.01 \text{ m}$ ,
- $r_e = 100 \text{ m}$ .

The following estimate of the time to obtain semi-steady state is given by (22):

$$t > \frac{\phi\mu cA}{k} \quad (9.10.2)$$

where

- $\phi$  = porosity, 0.1,
- $c$  = formation compressibility,  $1.0 \times 10^{-8} [\text{Pa}^{-1}]$ ,



$A =$  reservoir area,  $\pi r_e^2$  [m<sup>2</sup>].

The time to semi-steady state is approximately

$$t > \frac{\phi \mu c \pi r_e^2}{k} = \frac{(0.1)(1.8 \times 10^{-3})(1.0 \times 10^{-8})\pi(100^2)}{1.8 \times 10^{-12}} = \pi(10^4) \text{ s.} \quad (9.10.3)$$

The simulation is run to  $1.0 \times 10^5$  s.

A plot of the analytical solution is shown in Figure 9.10.1. Numerical values for the analytical solution are shown in Table 9.10.1.

### 9.10.2 Test Procedure

The BRAGFLO validation tests are run using the WIPP PA run control system. The scripts and script input files that run the validation tests are stored in CMS. All test inputs are fetched at run time by the scripts. All test outputs/results and run logs are stored in CMS by the scripts in class QB0600 of the CMS library, WP\$CMSROOT:[BF]. Other files related to the validation of BRAGFLO 6.0 are submitted for storage in CMS by the SCMS Librarian and reside in QB0600 class of the CMS library.

The Fortran code, BF2\_TEST10\_POST.FOR, was used in the validation of BRAGFLO 4.10. It may need to be modified to accommodate additional information in the ASCII output file, BF2\_QB0600\_TEST10.OUT, from BRAGFLO 6.0, but all files and code used in the validation will be stored in CMS class QB0600. The executable file of the Fortran code is run to perform several post-processing functions: 1) It extracts results from the BRAGFLO ASCII output file; 2) it calculates the analytical solution at the same radial distances from the wellbore at which BRAGFLO has output results; 3) it calculates the absolute and relative errors in the BRAGFLO results compared with the analytical results; and 4) it places the results for both BRAGFLO and the analytical solution into a data file, BF2\_TEST10.DAT, which is input to the plotting software, SPLAT. The resulting plot of pressure drawdown vs.  $\ln(r/r_w)$  reproduces Figure 9.10.1 with BRAGFLO results superimposed. Results for the analytical solution at radial distances from the wellbore center at which BRAGFLO should produce results are shown in Table 9.10.1.

### 9.10.3 Input Files

The grid for the BRAGFLO simulation, which approximates radial geometry using a Cartesian grid, was generated using the program, BF2\_TEST10\_RGRID.FOR. The output from this program was a file, BF2\_TEST10\_RGRID.DAT, that contains DELX and DELZ values for the BRAGFLO input file. These values were manually inserted into the BRAGFLO input file.

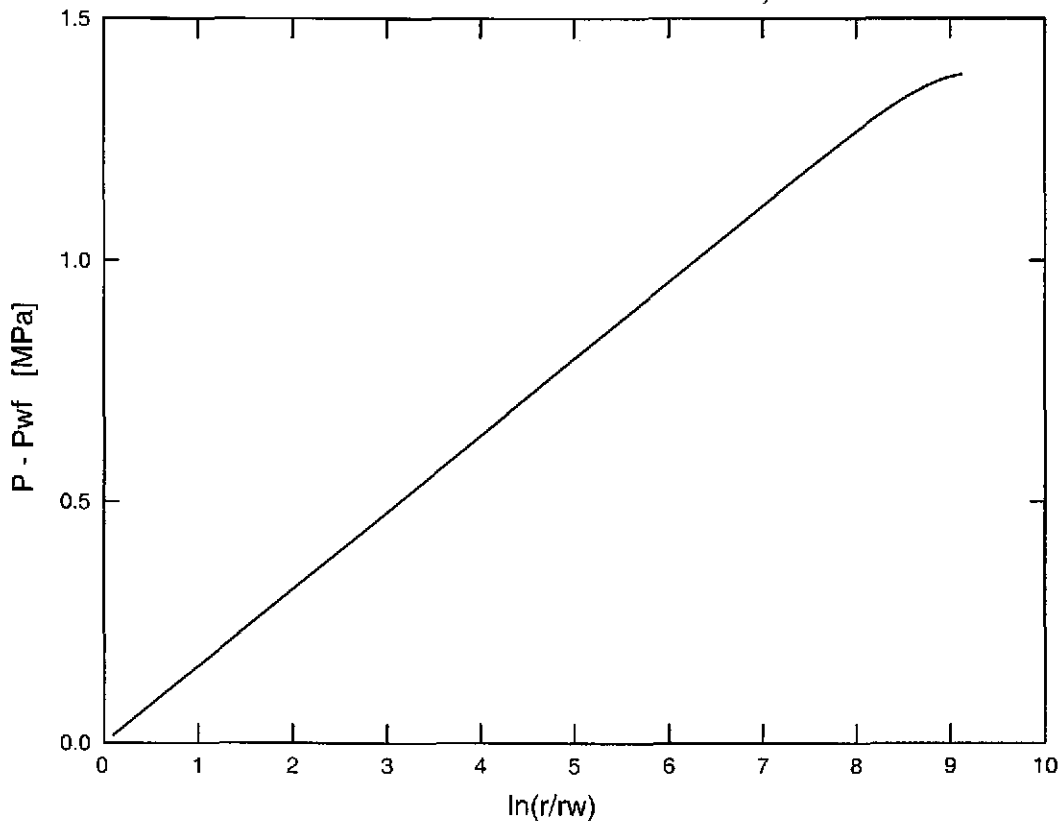
The BRAGFLO input files for Test Case #10 are called BF2\_QB0600\_TEST10.INP and BF2\_CLOSURE.DAT. Additional parameters have been added to the input file to suppress the new models added to BRAGFLO 6.0 compared with BRAGFLO 5.0. Otherwise, the input file,

BF2\_QB0600\_TEST10.INP, is identical to BF2\_QA0500\_TEST10.INP, which is the input file for Test Case #10 in the validation of BRAGFLO 5.0.

#### 9.10.4 Acceptance Criteria

The acceptance criteria used for this test are comparisons with analytical solutions. Results from Test Case #10 should agree within 10% relative error with the analytical solution. The closeness with which the BRAGFLO results agree with the analytical solution depends on the mesh size, the time step sizes, and the convergence tolerances specified by the user. Exact agreement is not expected because of the discretization errors and round-off inherent in any numerical solution of a system of differential equations. It is up to the analyst to determine how accurate the solution must be for the intended purpose of the calculation and how to achieve that degree of accuracy using BRAGFLO. The BRAGFLO results should, however, show the same trends as the analytical solution. In a plot of pressure vs. log of the radial distance from the well, when a semi-steady state has been reached at time  $t = 10^5$  s, the pressure at the well [ $\ln(r/r_w) = 0.0$ ] should be low. The pressure should increase monotonically and linearly away from the well. Because close agreement between BRAGFLO and the analytical solution is possible only if BRAGFLO properly maintains no flow boundaries, this will verify Functional Requirement R.4 and R.18.

**FIGURE 9.10.1 ANALYTICAL SOLUTION FOR TEST CASE #10: PRESSURE  
DRAWDOWN AT SEMI-STEADY STATE TIME, T = 105 S.**



**TABLE 9.10.1 ANALYTICAL SOLUTION FOR TEST CASE #10,  
FROM BF2 TEST10.DAT**

	Analytical
0.09839	0.015660
0.28636	0.045575
0.47433	0.075491
0.66229	0.105407
0.85026	0.135323
1.03822	0.165238
1.22619	0.195154
1.41416	0.225070
1.60212	0.254986
1.79009	0.284901
1.97805	0.314817
2.16602	0.344733
2.35399	0.374649
2.54195	0.404564
2.72992	0.434480
2.91788	0.464396
3.10585	0.494311
3.29382	0.524227
3.48178	0.554142
3.66975	0.584058
3.85772	0.613973
4.04568	0.643888
4.23365	0.673802
4.42161	0.703716
4.60958	0.733629
4.79755	0.763542
4.98551	0.793452
5.17348	0.823360
5.36144	0.853264
5.54941	0.883164
5.73738	0.913055
5.92534	0.942936
6.11331	0.972801
6.30128	1.002643
6.48924	1.032450
6.67721	1.062209
6.86517	1.091896
7.05314	1.121478
7.24111	1.150908
7.42907	1.180116
7.61704	1.209002
7.80500	1.237417
7.99297	1.265148
8.18094	1.291882
8.36890	1.317164
8.55687	1.340331
8.74483	1.360418
8.93280	1.376020
9.12077	1.385090

## 9.11 Test Case #11. Pressure and Density of Water Column in Equilibrium

### 9.11.1 Test Objective

The purpose of this test is to verify that the mass balance equations that BRAGFLO solves are implemented correctly by comparing BRAGFLO results with an analytical solution for a problem that considers the pressure and density at the bottom of a column of water in gravity equilibrium. This is a test of Functional Requirement R.15 and R.18.

The mass balance equations that BRAGFLO solves are:

$$\begin{aligned} & \frac{\partial}{\partial x} \left[ \frac{\alpha \rho k_x}{\mu} \left( \frac{\partial P}{\partial x} + \rho g \frac{\partial D}{\partial x} \right) \right] + \frac{\partial}{\partial y} \left[ \frac{\alpha \rho k_y}{\mu} \left( \frac{\partial P}{\partial y} + \rho g \frac{\partial D}{\partial y} \right) \right] + \\ & \frac{\partial}{\partial z} \left[ \frac{\alpha \rho k_z}{\mu} \left( \frac{\partial P}{\partial z} + \rho g \frac{\partial D}{\partial z} \right) \right] + \alpha q = \frac{\partial}{\partial t} (\alpha \phi \rho S). \end{aligned} \quad (9.11.1)$$

where

$x, y, z$	= grid dimension [m],
$\alpha$	= geometric factor, dependent upon dimensions of problem
$\rho$	= density [kg/m <sup>3</sup> ]
$k_x, k_y, k_z$	= effective permeability [m <sup>2</sup> ],
$\mu$	= viscosity [Pa s],
$P$	= pressure [Pa],
$g$	= local acceleration of gravity [m/s <sup>2</sup> ],
$D$	= elevation [m],
$q$	= all sources combined [kg/m <sup>3</sup> s],
$t$	= time [s],
$\phi$	= porosity [m <sup>3</sup> void/m <sup>3</sup> rock],
$S$	= saturation [m <sup>3</sup> phase/m <sup>3</sup> void volume],

The test problem considers a water column 500 m high subdivided into 50 grid blocks, each 10 m thick. The elevation change between the top and bottom grid block centers is 490 m. Water compressibility is  $1.0 \times 10^{-8} \text{ Pa}^{-1}$ , a value that is larger than actual water compressibility and used in order to magnify the effects of density change for this test problem. Initial pressure is 10 MPa throughout the grid. BRAGFLO is run until gravity equilibrium is obtained ( $1 \times 10^6$  sec). The conditions specified by BRAGFLO at the top of the water column are taken as reference conditions for the analytic solution. The analytic solution at the bottom of the column is then compared to the BRAGFLO solution at the bottom grid block.

### 9.11.2 Test Procedure

The BRAGFLO validation tests are run using the WIPP PA run control system. The scripts and script input files that run the validation tests are stored in CMS. All test inputs are fetched at run time by the scripts. All test outputs/results and run logs are stored in CMS by the scripts in class QB0600 of the CMS library, WP\$CMSROOT:[BF]. Other files related to the validation of BRAGFLO 6.0 are submitted for storage in CMS by the SCMS Librarian and reside in QB0600 class of the CMS library.

The BRAGFLO output file BF2\_QB0600\_TEST11.OUT is examined. From this file the reference pressures and densities at elevation  $z=0$  are obtained and inputted to the analytic code input file BF2\_TEST11\_ANALY\_PA97.DAT. The analytic solution code BF2\_TEST11\_ANALY\_PA97.FOR is run, and the gravity equilibrium values for water pressure and density at  $z=490$  m are obtained. These are compared with the BRAGFLO results in BF2\_QB0600\_TEST11.OUT at  $z=490$ . The analytic code takes pressure and density at a reference location and calculates pressures and densities at any depth due to gravity equilibrium. Derivation of the analytic solution is found in "Analysis Package for the Salado Flow Calculation (Task1) of the Performance Assessment Analysis Supporting the Compliance Certification Application", Section 3.2.3 (24). A portion of that discussion is presented at this point.

For compressible fluids the hydraulic head,  $h$ , is defined by

$$h = z + \frac{1}{g} \int_{p_o}^p \frac{dp}{\rho(p)} \quad (9.11.2)$$

where  $p$  is the pressure at elevation  $z$ ,  $g$  is acceleration of gravity, and  $\rho$  is the fluid density. In BRAGFLO an equation of state relates brine density to brine pressure by

$$\rho = \rho_o \exp(\beta(p - p_o)) \quad (9.11.3)$$

where  $\rho_o$  is the density at reference pressure  $p_o$  and  $\beta$  is the brine compressibility.

From the equation of state, Eq 9.11.3, and the expression of hydraulic head, Eq 9.11.2, the hydraulic head may be expressed as

$$h = z + \frac{1}{g\beta} \left( \frac{1}{\rho_o} - \frac{1}{\rho} \right) \quad (9.11.4)$$

Based on initial brine pressure,  $p_{ref}$ , the hydraulic head at the reference location,  $h_o$ , is calculated as

$$h_o = z_{ref} + \frac{1}{g\beta} \left( \frac{1}{\rho_o} - \frac{1}{\rho(p_{ref})} \right) \quad (9.11.5)$$

Solving the hydraulic head equation, Eq. 9.11.4, for the brine density and imposing the hydraulic equilibrium condition that  $h = h_o$  (where  $h_o$  is the initial hydraulic head at the reference elevation,  $z_{ref}$ ), gives density as a function of elevation

$$\rho = \frac{1}{g\beta \left( z - h_o + \frac{1}{g\beta\rho_o} \right)} \quad (9.11.6)$$

If the elevation,  $z$ , of a grid block is known, then the brine density is computed from Eq. 9.11.6. Brine pressure is then computed by solving the brine equation of state, Eq. 9.11.3, for pressure

$$p = p_o + \frac{1}{\beta} \ln \left( \frac{\rho}{\rho_o} \right) \quad (9.11.7)$$

A table containing values of pressure and density for the analytic solutions and the BRAGFLO solutions based on the results from BRAGFLO Version 6.0 is produced.

### 9.11.3 Input Files

The BRAGFLO input files for Test Case #11 are called BF2\_QB0600\_TEST11.INP and BF2\_CLOSURE.DAT. Additional parameters have been added to the input file to suppress the new models added to BRAGFLO 6.0 compared with BRAGFLO 5.0. Otherwise, the input file, BF2\_QB0600\_TEST11.INP, is identical to BF2\_QA0500\_TEST11\_DENNEW.INP, which is the input file for Test Case #11 in the validation of BRAGFLO 5.0.

Input files for the analytic codes are created from results taken from the BRAGFLO output files. They are not presented here but will be presented in the validation document for BRAGFLO, Version 6.0.

### 9.11.4 Acceptance Criteria

The acceptance criteria used for this test are comparisons with analytical solutions. BRAGFLO results for this simple test case should agree with the analytical solutions through 3 significant digits in both pressure and density for BRAGFLO, Version 6.0. This will verify Functional Requirement R.15 and R.18.

## **9.12 Test Case #12. Direct Brine Release**

### **9.12.1 Test Objective**

The purpose of this test is to verify that BRAGFLO, Version 6.0, can read successfully an input file designed to model a direct brine release featuring a single waste region, as was done for the Compliance Certification Application (CCA) using BRAGFLO, Version 4.01. This is a test of Functional Requirement R.2 and R.18.

The test problem is taken from the suite of BRAGFLO DBR runs evaluated for the 1996 CCA analysis using BRAGFLO, Version 4.01 (BF4\_BRAGFLO). It consists of two BRAGFLO runs. The first models direct brine releases for a second intrusion at 1200 yr. into the same waste panel that previously experienced an initial intrusion that penetrated both the repository and an underlying brine reservoir in the Castile formation at 1000 yr. The second BRAGFLO run models direct brine releases for a second intrusion at 1200 yr. into a different waste panel than one that previously experienced an initial intrusion that penetrated both the repository and an underlying brine reservoir in the Castile formation at 1000 yr.

### **9.12.2 Test Procedure**

The BRAGFLO validation tests are run using the WIPP PA run control system. The scripts and script input files that run the validation tests are stored in CMS. All test inputs are fetched at run time by the scripts. All test outputs/results and run logs are stored in CMS by the scripts in class QB0600 of the CMS library, WP\$CMSROOT:[BF]. Other files related to the validation of BRAGFLO 6.0 are submitted for storage in CMS by the SCMS Librarian and reside in QB0600 class of the CMS library.

BRAGFLO, Version 6.0 output files, BF2\_QB0600\_R1\_S3\_V046\_T1200\_LOWER.OUT and BF2\_QB0600\_R1\_S3\_V046\_T1200\_UP.OUT, are compared against similar output files run using BRAGFLO, Version 4.10, to confirm that information written to the output files meets the content and print frequency requirements specified in the input files. Explanations for differences between the output files are provided. BRAGFLO, Version 4.10 output files, BF4\_R1\_S3\_V046\_T1200\_LOWER.OUT and BF4\_R1\_S3\_V046\_T1200\_UP.OUT, used for this comparison are stored in the CMS and may be retrieved from there if needed.

### **9.12.3 Input Files**

The BRAGFLO input files are called BF2\_QB0600\_R1\_S3\_V046\_T1200\_LOWER.INP, BF2\_QB0600\_R1\_S3\_V046\_T1200\_UP.INP, and BF2\_CLOSURE.DAT. Additional parameters have been added to the input file to suppress the new models added to BRAGFLO 6.0 compared with BRAGFLO 5.0. Otherwise, the input files, BF2\_QB0600\_R1\_S3\_V046\_T1200\_LOWER.INP, BF2\_QB0600\_R1\_S3\_V046\_T1200\_UP.INP, are identical to BF2\_QA0500\_R1\_S3\_V046\_T1200\_LOWER.INP,

BF2\_QA0500\_R1\_S3\_V046\_T1200\_UP.INP, which are the input files for Test Case #12 in the validation of BRAGFLO 5.0.

#### **9.12.4 Acceptance Criteria**

The acceptance criterion used for Test Case #12 is manual inspection of the output from the test case. Visual inspection of the ASCII output files should confirm that the input that describes the test case has been read in correctly. The frequency of output to the ASCII and binary output files and the specific parameters written to the output files should agree with the specifications present files in the input, verifying Functional Requirement R.2 and R.18.



## **9.13 Test Case #13. Error Reporting for Incorrect Number of Waste Material Regions**

### **9.13.1 Test Objective**

There must be a separate waste material region for each region of the model that is to contain waste [R.19]. In order to test requirement R.19, the input file for Test Case #13 is altered so that there is only one waste material region for two regions, WAS\_AREA and REPOSIT, that will contain waste. Test Case #13 is run with the incorrect input file, and BRAGFLO should terminate with an error message.

### **9.13.2 Test Procedure**

The BRAGFLO validation tests are run using the WIPP PA run control system. The scripts and script input files that run the validation tests are stored in CMS. All test inputs are fetched at run time by the scripts. All test outputs/results and run logs are stored in CMS by the scripts in class QB0600 of the CMS library, WP\$CMSROOT:[BF]. Other files related to the validation of BRAGFLO 6.0 are submitted for storage in CMS by the SCMS Librarian and reside in QB0600 class of the CMS library.

### **9.13.3 Input Files**

The BRAGFLO input files for Test Case #13 are called BF2\_QB0600\_TEST13.INP and BF2\_CLOSURE.DAT. The file, BF2\_QB0600\_TEST13.INP, is the same as the input file for Test Case #6 except that it has been manually edited to have one instead of two waste materials.

### **9.13.4 Acceptance Criteria**

The sole acceptance criterion for Test Case #13 is that BRAGFLO will terminate with an error message in the .OUT file, that contains the words, "Error in READMAT: Two identical waste material regions are specified: ", since there is only one waste material for two regions that contain waste (WAS\_AREA and REPOSIT). Successful completion of Test Case #13 confirm that Functional Requirement R.19 is satisfied.

## 9.14 Test Case #14. Additional Iron and MgO Chemistry.

### 9.14.1 Test Objective

The purpose of this test is to exercise the new functional requirements introduced for BRAGFLO 6.0 for the new chemistry model (R.20-R.23), as well as the model to smoothly change the permeability of materials as a function of time (R.24). Furthermore, this test case assesses the previous requirements with new additions, such as, the MgO initial concentration setup (R.5), the reset capability of during a material change (R.7) and the additional relative permeability and capillary pressure models (R.8). Moreover, this test case tests the basic Functional Requirements R.1 to R.3, R.6, and R.11 to R.17, as well as External Interface Requirements R.26 and R.27, although these requirements are not explicitly examined.

The 1-D test case is discretized into 20 distinct 1 meter sections (Figure 9.14.1). Four separate waste areas are designated, each with varying Iron/Cellulosics/MgO concentrations (R.5) as seen in Table 9.14.1. The Waste area #1 is effectively separated from the other waste areas by a section of material with a very low permeability ( $10^{-35} \text{ m}^2$ ). Waste area #1 (section 2) is initialized with Iron, Cellulosics and MgO, with zero saturation. The saturation slowly increases due to flow from the adjacent section and as closure occurs. The chemistry rates in this area should be zero until the saturation cutoff is reached (R.21). Waste area #2 (section 6) is initialized with only MgO to employ only the MgO hydration reaction. Waste area #3 (section 10) is initialized with Cellulosics and MgO to utilize the MgO hydration and carbonation reactions. Waste area #4 (section 14) is initialized with Iron and Cellulosics to exercise the Iron sulfidation reactions. The chemistry rates in each waste area are proportional to the initial concentration (R.22), with the volume of solids produced, calculated in each waste area (R.23). At 8,000 years, the saturation for Waste area #1 is set to increase to 0.5, but the chemical species will be reset to zero (R.7).

To facilitate brine to the reactions for waste areas 2 through 4, wells are used to introduce brine and regulate the pressure. As seen represented by the arrows in Figure 9.14.1, on the left side of the waste areas there is a well that injects  $10^{-16} \text{ kg/s}$  of brine, while on the right side, there is a well with a productivity index of  $10^{-6} \text{ m}^3$ . This effectively keeps the pressure constant and the saturation high for waste areas 2 through 4.

Sections 18 and 19, contain material that will smoothly change permeability from 1,000 to 2,000 years and then back to the original permeability from 8,000 to 9,000 years (R.24). The pressure and saturation of Sections 18 and 19 will also be changed at 8,000 years (R.7).

Section 3 simulates an open cavity and is used to exercise a new relative permeability and capillary pressure model, while the new model for the waste area will also be used (R.8).



then use GROPE to select data at a particular grid block. The specific parameters written to the output files should agree with the specifications present in the input, verifying Functional Requirement R.18.

*Initial concentrations.*

For Test Case #14, the tester should verify by manual inspection that the initial concentration of MgO specified in the input file is reported in the output file, BF2\_QB0600\_TEST14.OUT. This verifies the new addition to Functional Requirement R.5 for BRAGFLO 6.0.

*Material change reset model.*

Test Case #14 will test the new capability to modify the pressure and saturation, as well as the capability to reset the chemistry to zero. This test case is setup to reset the pressure and saturation of sections 18 and 19 at 3,000 years to  $6.0 \times 10^5$  Pa and 0.5, respectively. For Waste areas #2-4, the test case is setup to test that there is no change in pressure, saturation or chemistry as specified in the input file. Waste area #1 is setup to have the chemical concentrations reset to zero at 8,000 years.

The tester should verify by manual inspection that the following values specified in the input file are reported in the output file, BF2\_QB0600\_TEST14.OUT:

TIMEBORE(1)	= $9.4673 \times 10^{10}$ s,
MATBORE(1)	= 3,
PORESET(1)	= $6.000 \times 10^5$ Pa,
SORESET(1)	= 0.5,
ICHEM(1)	= F,
TIMEBORE(2)	= $9.4673 \times 10^{10}$ s,
MATBORE(2)	= 7,
PORESET(2)	= Pressure is not reset,
SORESET(2)	= Brine Satn is not reset,
ICHEM(2)	= F,
TIMEBORE(3)	= $2.5426 \times 10^{11}$ s,
MATBORE(3)	= 8,
PORESET(3)	= Pressure is not reset,
SORESET(3)	= Brine Satn is not reset,
ICHEM(3)	= T.

Because BRAGFLO solves the mass balance equations using a fully implicit technique, all values of dependent variables (gas saturation and brine pressure), as well as all functions of these

variables, are valid over the time step just completed. Therefore, the tester can use any reported values at any time for verification and should find agreement with the results printed to the output file.

To test the new capability to reset conditions after a material change, results from blocks in the material set in the input file must be selected. For this test case, there are 6 cells with I = 2, 6, 10, 14, 18, and 19. If GROPE is used to extract data from the .CDB file, the elements are numbered 6 to 9 and 18 to 19. Choose a block, and find the values of the pressure, saturation and chemical concentrations, before and after 8,000 years, and compare. The results should show that the values of pressure, saturation and chemistry changed as specified in the input file. Values can be checked in as many of the 6 blocks as necessary to satisfy the testers needs. This tests Functional Requirements R.7 for the new reset model specific to Test Case #14.

*Relative permeability and capillary pressure model.*

Test Case #14 will test the two new relative permeability and capillary pressure models: an open cavity model (KRP=11), and a modification of the KRP=4 model in which the saturation cutoff is accounted for and the residual brine saturation is modified for the capillary pressure model (KRP=12). Both of these models are explicit functions of saturation and are easily verified.

The open cavity model (KRP = 11) provides relative permeabilities and capillary pressures from the following:

$$k_{rw} = \begin{cases} 0 & S_w \leq S_{wr} \\ (S_w - S_{wr})/TOL & S_{wr} < S_w \leq S_{wr} + TOL \\ 1 & S_{wr} + TOL < S_w \end{cases} \quad (9.14.1)$$

$$k_{rg} = \begin{cases} 0 & 1 - S_w \leq S_{gr} \\ (1 - S_w - S_{gr})/TOL & S_{gr} < 1 - S_w \leq S_{gr} + TOL \\ 1 & S_{gr} + TOL < 1 - S_w \end{cases} \quad (9.14.2)$$

$$P_c = 0 \quad (9.14.3)$$

The residual brine saturation is an input parameter,  $S_{wr} = SBR$ , the residual gas saturation is an input parameter,  $S_{gr} = SGR$ , and the tolerance is an input parameter,  $TOL = TOL$ .

The gas pressure is obtained from the brine pressure,  $P_b$ , and the capillary pressure,  $P_c$ :

$$P_g = P_b + P_c. \quad (9.14.4)$$

The tester should verify by manual inspection that the following value specified in the input file is reported in the output file, BF2\_QB0600\_TEST14.OUT:

$$TOL = TOL = 0.01.$$

The tester can take any reported value of brine saturation and perform these calculations. A grid block must be chosen in which the material uses the open cavity model, KRP = 11. For this test case, there is 1 cell with I = 3 that uses the KRP = 11 model. If GROPE is used to extract data from the .CDB file, the element is numbered 10. The results should agree to three or four significant figures with values of relative permeability to brine, relative permeability to gas, and gas pressure reported in the output files.

The modification of the KRP = 4 model (KRP=12) gives relative permeabilities and capillary pressures from

$$k_{rw} = S_e^{(2+3\lambda)/\lambda} \quad (9.14.5)$$

$$k_{rg} = (1 - S_{eg})^2 (1 - S_{eg}^{(2+\lambda)/\lambda}) \quad (9.14.6)$$

$$P_c = \frac{P_t}{S_{me}^{1/\lambda}}, \quad (9.14.7)$$

where the modified brine saturation is

$$S_e = \frac{S_w - S_{wr}}{1 - S_{wr}} \quad (9.14.8)$$

the modified gas saturation is

$$S_{eg} = \frac{S_w - S_{wr}}{1 - S_{gr} - S_{wr}} \quad (9.14.9)$$

and the modified effective brine saturation is

$$S_{me} = \frac{S_w - (S_{co} - S_{e\min})}{1 - (S_{co} - S_{e\min})}. \quad (9.14.10)$$

The parameters  $\lambda$ ,  $S_{co}$  and  $S_{e\min}$  are the input parameters XLAMDA, SOCMIN and SOCEFFMIN.

The  $P_t$  = threshold capillary pressure, which is correlated to permeability is calculated by:

$$P_t = ak^\eta, \quad (9.14.11)$$

The parameters in this correlation are input as  $a = \text{PCT\_A}$  and  $\eta = \text{PCT\_EXP}$ .

The tester should verify by manual inspection that the following values specified in the input file are reported in the output file, BF2\_QB0600\_TEST14.OUT:

$$S_{co} = \text{SOCMIN} = 0.015$$

$$S_{emin} = \text{SOCEFFMIN} = 0.001.$$

The tester can take any reported value of brine saturation and brine permeability and perform these calculations. A grid block must be chosen in which the material uses the modified model, KRP = 12. For this test case, there are 4 cells with I = 2, 6, 10 and 14 that use the KRP = 12 model. If GROPE is used to extract data from the .CDB file, the elements are numbered 6 to 9. The results should agree to three or four significant figures with values of relative permeability to brine, relative permeability to gas, and gas pressure reported in the output files. This tests Functional Requirements R.8 for the relative permeability and capillary pressure models specific to Test Case #14.

*Saturation dependent chemistry rates.*

For Test Case #14, the iron corrosion rate, cellulose (CH<sub>2</sub>O) microbial degradation rate and MgO hydration rate,  $q_{rc}$ ,  $q_{rm}$  and  $q_{rh}$  (mol s<sup>-1</sup>), are functions of the saturation and are proportional to the initial concentration of Fe, CH<sub>2</sub>O, and MgO in each cell,  $C_{Fe}^0$ ,  $C_{CH_2O}^0$  and  $C_{MgO}^0$  (mol m<sup>-3</sup>), respectively,

$$\begin{aligned} q_{rc} &= (r_{ci}S_{cw} + r_{ch}S_{ncw})C_{Fe}^0 V \\ q_{rm} &= (r_{mi}S_{cw} + r_{mh}S_{ncw})C_{CH_2O}^0 V \\ q_{rh} &= (r_{hi}S_{cw} + r_{hh}S_{ncw})C_{MgO}^0 V \end{aligned} \tag{9.14.12}$$

where

- $r_{ci}$  is the intrinsic iron corrosion rate under inundated conditions (s<sup>-1</sup>),
- $r_{ch}$  is the intrinsic iron corrosion rate under humid conditions (s<sup>-1</sup>),
- $r_{mi}$  is the intrinsic cellulose microbial degradation rate under inundated conditions (s<sup>-1</sup>),
- $r_{mh}$  is the intrinsic cellulose microbial degradation rate under humid conditions (s<sup>-1</sup>),
- $r_{hi}$  is the intrinsic MgO hydration rate under inundated conditions (s<sup>-1</sup>),
- $r_{hh}$  is the intrinsic MgO hydration rate under humid conditions (s<sup>-1</sup>),
- $S_{cw}$  is the effective chemistry brine or wetting-phase saturation,
- $S_{ncw}$  is the effective chemistry gas or non-wetting-phase saturation ( $S_{ncw} = 1 - S_{cw}$ ),
- $V$  is the volume of the grid cell (m<sup>3</sup>).

In Test Case #14, the humid rates are set to zero, so equation 9.14.13 for the inundated condition reduces to

$$\begin{aligned} q_{rci} &= r_{ci}S_{cw}C_{Fe}^0 V \\ q_{rmi} &= r_{mi}S_{cw}C_{CH_2O}^0 V \\ q_{rhi} &= r_{hi}S_{cw}C_{MgO}^0 V \end{aligned} \tag{9.14.13}$$

where

- $q_{rci}$  is the iron corrosion rate under inundated conditions (mol Fe s<sup>-1</sup>),
- $q_{rmi}$  is the cellulose microbial degradation rate under inundated conditions (mol CH<sub>2</sub>O s<sup>-1</sup>),
- $q_{rhi}$  is the MgO hydration rate under inundated conditions (mol MgO s<sup>-1</sup>).

The effective chemistry brine or wetting-phase saturation is calculated by taking the brine saturation in the cell, subtracting the cutoff saturation value and adding the smoothed wicking term

$$S_{cw} = S_w - S_{co} + W \left\{ 1 - \exp \left[ 200\alpha (S_{wc} - S_{co})^2 \right] \right\} \quad (9.14.14)$$

where

- $S_{co}$  is the brine or wetting-phase saturation cutoff value,
- $W$  is the wicking saturation,
- $\alpha$  is the smoothing exponent.

The effective chemistry brine saturation is bounded to have a value minimum value of 0.0 and a maximum value of 1.0, regardless of cutoff value and wicking saturation.

The tester should verify by manual inspection that the following values specified in the input file are reported in the output file, BF2\_QB0600\_TEST14.OUT:

$r_{ci}$	= RK(1)	= $3.000 \times 10^{-10} \text{ s}^{-1}$ ,
$r_{mi}$	= RK(2)	= $2.000 \times 10^{-10} \text{ s}^{-1}$ ,
$r_{hi}$	= BRUCITEI	= $1.000 \times 10^{-9} \text{ s}^{-1}$ ,
$r_{ch}/r_{ci}$	= HF(1)	= 0.0,
$r_{mh}/r_{mi}$	= HF(2)	= 0.0,
$r_{hh}$	= BRUCTIEH	= $0.0 \text{ s}^{-1}$
$S_{co}$	= SOCMIN	= 0.015
$W$	= SATWICK	= 1.0
$\alpha$	= ALPHARXN	= 1,000.

Because BRAGFLO solves the mass balance equations using a fully implicit technique, all values of dependent variables (gas saturation and brine pressure), as well as all functions of these variables, are valid over the time step just completed. Therefore, the tester can use any reported values at any time for verification simply by inserting the values into the equations above and should find agreement with the results printed to the output file.

To test the chemistry, results from a waste grid block must be selected. For this test case, there are 4 waste cells with I = 2, 6, 10 and 14. If GROPE is used to extract data from the .CDB file, the waste elements are numbered 6 to 9. At any time after zero, choose a waste grid block, and



find the values of either gas saturation or brine saturation, or both (although, since  $S_w = 1 - S_{nw}$ , only one of the saturations is needed). Using the values for the brine or wetting-phase saturation cutoff value,  $S_{co}$ , the wicking saturation,  $W$ , and the smoothing exponent,  $\alpha$ , calculate the effective brine or wetting-phase saturation,  $S_w$ , using equations 9.14.14. Then, using the effective brine or wetting-phase saturation, the initial concentrations of iron, cellulose and MgO,  $C_{Fe}$ ,  $C_{CH_2O}$  and  $C_{MgO}$ , the volume of the grid cell,  $V$ , and the intrinsic iron corrosion, cellulose microbial degradation and MgO hydration rates under inundated conditions to calculate the iron corrosion, cellulose microbial degradation and MgO hydration reaction rates under inundated conditions using equation 9.14.13. The results for the iron corrosion, cellulose microbial degradation and MgO hydration rates under inundated conditions,  $q_{rci}$ ,  $q_{rmi}$  and  $q_{rhi}$ , should agree to three or four significant figures with the values reported in the BRAGFLO output file under “Inundated corrosion rate”, “Inundated biodegradation rate” and “MgO hydration rate” (CORRATI, BIORATI and MGO\_HR in the .CDB file), respectively. Values can be checked in as many of the 4 waste grid blocks as necessary to satisfy the testers needs. This verifies Functional Requirements R.20, R.21, and R.22 for the saturation dependent chemistry rates.

*Cellulose microbial degradation dependent chemistry rates.*

The sulfidation and carbonation rates are proportional to the cellulose microbial degradation rate,  $q_{rm}$ .

$$\begin{aligned} q_{rsulf} &= s_{sulf} q_{rm} \\ q_{rcarb} &= s_{carb} q_{rm} \end{aligned} \tag{9.14.15}$$

where

- $q_{rsulf}$  = the sulfidation rate (mol H<sub>2</sub>S s<sup>-1</sup>),
- $q_{rcarb}$  = the carbonation rate (mol CO<sub>2</sub> s<sup>-1</sup>),
- $s_{sulf}$  = the stoichiometric coefficient for H<sub>2</sub>S in the cellulose microbial degradation reaction (mol H<sub>2</sub>S/mol CH<sub>2</sub>O),
- $s_{carb}$  = the stoichiometric coefficient for CO<sub>2</sub> in the cellulose microbial degradation reaction (mol CO<sub>2</sub>/mol CH<sub>2</sub>O).

The sulfidation and carbonation is assumed to preferentially react with the Fe(OH)<sub>2</sub> and Mg(OH)<sub>2</sub> before the Fe and MgO, respectively. The sulfidation and carbonation reactions of Fe and MgO, were added for the case when the cellulose microbial degradation rate is much faster than the iron corrosion and MgO hydration reactions, respectively. The transition from Fe(OH)<sub>2</sub> and Mg(OH)<sub>2</sub> to Fe and MgO reacting is smoothed by the following equations, based on the Fe(OH)<sub>2</sub> and Mg(OH)<sub>2</sub> concentrations,  $C_{FeOH_2}$  and  $C_{MgOH_2}$ , respectively.

$$\begin{aligned}
 q_{rsulf\_FeOH2} &= q_{rsulf} \left[ 1 - \exp\left( \alpha \frac{C_{FeOH2}}{C_{Fe}^0} \right) \right] \\
 q_{rsulf\_Fe} &= q_{rsulf} - q_{rsulf\_FeOH2} \\
 q_{rcarb\_MgOH2} &= q_{rcarb} \left[ 1 - \exp\left( \alpha \frac{C_{MgOH2}}{C_{MgO}^0} \right) \right] \\
 q_{rcarb\_MgO} &= q_{rcarb} - q_{rcarb\_MgOH2}
 \end{aligned}
 \tag{9.14.16}$$

where

- $q_{rsulf\_FeOH2}$  = the iron hydroxide sulfidation rate (mol H<sub>2</sub>S s<sup>-1</sup>),
- $q_{rsulf\_Fe}$  = the iron sulfidation rate (mol H<sub>2</sub>S s<sup>-1</sup>),
- $q_{rcarb\_MgOH2}$  = the Mg(OH)<sub>2</sub> carbonation rate (mol CO<sub>2</sub> s<sup>-1</sup>),
- $q_{rcarb\_MgO}$  = the MgO carbonation rate (mol CO<sub>2</sub> s<sup>-1</sup>)
- $q_{rsulf}$  = calculated in Equation 9.14.15,
- $q_{rcarb}$  = calculated in Equation 9.14.15.

The tester should verify by manual inspection that the following values specified in the input file are reported in the output file, BF2\_QB0600\_TEST14.OUT:

- $s_{sulf}$  = RXH2S(1) = 0.5,
- $s_{sulf}$  = RXH2S(2) = 0.5,
- $s_{carb}$  = RXCO2(1) = 1.0.
- $s_{carb}$  = RXCO2(2) = 1.0.

To test the chemistry, results from a waste grid block must be selected. For this test case, there are 4 waste cells with I = 2, 6, 10 and 14. If GROPE is used to extract data from the .CDB file, the waste elements are numbered 6 to 9. At any time after zero, choose a waste grid block, and find the values of the cellulose microbial degradation rate,  $q_{rm}$ , using the procedure described above. Using the values for the cellulose microbial degradation rate, the stoichiometric coefficients for H<sub>2</sub>S and CO<sub>2</sub> in the cellulose microbial degradation reaction,  $s_{sulf}$  and  $s_{carb}$ , and the smoothing exponent,  $\alpha$ , calculate the sulfidation and carbonation rates,  $q_{rsulf}$  and  $q_{rcarb}$ , using equations 9.14.15. Then, using the sulfidation and carbonation rates, the Fe and MgO initial concentrations,  $C_{Fe}$  and  $C_{MgO}$ , the Fe(OH)<sub>2</sub> and Mg(OH)<sub>2</sub> concentrations,  $C_{FeOH2}$  and  $C_{MgOH2}$ , and the smoothing exponent,  $\alpha$ , calculate the Fe and Fe(OH)<sub>2</sub> sulfidation and the MgO and Mg(OH)<sub>2</sub> carbonation reaction rates using equation 9.14.16. The results for the Fe and Fe(OH)<sub>2</sub> sulfidation and the MgO and Mg(OH)<sub>2</sub> carbonation reaction rates,  $q_{rsulf\_Fe}$ ,  $q_{rsulf\_FeOH2}$ ,  $q_{rcarb\_MgO}$  and  $q_{rcarb\_MgOH2}$ , should agree to three or four significant figures with the values reported in the BRAGFLO output file under “Fe sulfidation rate”, “Fe(OH)<sub>2</sub> sulfidation rate”, “MgO carbonation rate” and “Mg(OH)<sub>2</sub> carbonation rate” (FE\_SR, FEOH2\_SR, MGO\_CR and MGOH2\_CR in the .CDB file), respectively. Values can be checked in as many of the 4 waste grid blocks as necessary to satisfy the testers needs.

For the case when there is no cellulose in the grid cell, the sulfidation and carbonation rates should be zero. If there is no Fe in the grid cell, the sulfidation rates should be zero. If there is no MgO in the grid cell, the carbonation rates should be zero. This verifies Functional Requirements R.20, R.21, and R.22 for the cellulose microbial degradation dependent chemistry rates.

*Additional chemistry tests.*

In addition, other quantities related to the chemistry rates (Table 9.14.2) can be tested if desired, using the stoichiometric factors listed in Table 9.14.3.

**TABLE 9.14.2 ADDITIONAL CHEMISTRY RATES TO BE TESTED  
 IN TEST CASE #14.**

Variable Name	Description	Units
H2RATE	H <sub>2</sub> generation rate–simple model	kg/(s·m <sup>3</sup> )
BRINRATE	Brine consumption rate–simple model	kg/(s·m <sup>3</sup> )
FERATE	Fe consumption rate–simple model	kg/(s·m <sup>3</sup> )
CELLRATE	Biodegrad consumption rate–simple model	kg/(s·m <sup>3</sup> )
FEOH2R	Fe(OH) <sub>2</sub> generation rate–simple model	kg/(s·m <sup>3</sup> )
FESR	FeS generation rate–simple model	kg/(s·m <sup>3</sup> )
MGOR	MgO generation rate–simple model	kg/(s·m <sup>3</sup> )
MGOH2R	Mg(OH) <sub>2</sub> generation rate–simple model	kg/(s·m <sup>3</sup> )
MGCO3R	MgCO <sub>3</sub> generation rate–simple model	kg/(s·m <sup>3</sup> )

The tester should verify by manual inspection that the stoichiometric coefficients for each reaction shown in Table 9.14.3 is found in the output file.

**TABLE 9.14.3 TEST CASE #14 STOICHIOMETRIC COEFFICIENTS.**

Rxn #	1	2	3	4	5	6	7
Variable	CORRATI	BIORATI	FEOH2_SR	FE_SR	MGO_HR	MGOH2_CR	MGO_CR
H2RATE	1	0.5	0	0	0	0	0
BRINRATE	-2	0	2	0	-1	1	0
FERATE	-1	0	0	-1	0	0	0
CELLRATE	0	-1	0	0	0	0	0
FEOH2R	1	0	-1	0	0	0	0
FESR	0	0	1	1	0	0	0
MGOR	0	0	0	0	-1	0	-1
MGOH2R	0	0	0	0	1	-1	0
MGCO3R	0	0	0	0	0	1	1

The additional chemistry rates in the first column of Table 9.14.3 can be calculated by multiplying the rates listed in row 2 of Table 9.14.3 by the corresponding stoichiometric coefficients in the table. For example, the calculation the variable FESR would be one times FEOH2\_SR plus one times FE\_SR. Because the consumption rates are reported in kg m<sup>-3</sup> s<sup>-1</sup>, the

molecular weight of each species, which should be found in the output file, are also needed. So for this example the variable FESR would be multiplied by the molecular weight of FeS.

The brine consumption rate (BRINRATE) will be multiplied by the molecular weight of brine, which is calculated from the salinity of the brine, in weight percent salt and the molecular weight of H<sub>2</sub>O,  $M_{w,H_2O}$ , which should be obtained from the output file, where it is echoed from the input:

$$m_s = \text{SALT} = 29.6 \text{ wt } \%$$

To get the brine consumption rate, it is multiplied by the effective brine molecular weight,  $M_{w,brine}$ :

$$M_{w,brine} = \frac{M_{w,H_2O}}{1 - \frac{m_s}{100}} \quad (9.14.17)$$

The rates should agree with the value reported to three or four significant figures.

#### *Solids production.*

As the chemical reactions occur, different chemical species with varying densities are produced, changing the volume of the solids. The total change in the volume of solids,  $\Delta V_s$  (m<sup>3</sup> solid/m<sup>3</sup> grid), can be calculated by:

$$\Delta V_s = \sum_i \Delta V_{si} \quad (9.14.18)$$

where the volume change for species i,  $\Delta V_{si}$  (m<sup>3</sup> species i/m<sup>3</sup> grid), is:

$$\Delta V_{si} = \frac{C_i - C_i^0}{\rho_i} \quad (9.14.19)$$

where

- $C_i$  = the concentration of species i (kg species i/m<sup>3</sup> grid),
- $C_i^0$  = the initial concentration of species i (kg species i/m<sup>3</sup> grid),
- $\rho_i$  = the density of species i (kg species i/ m<sup>3</sup> species i).

The tester should verify by manual inspection that the following values specified in the input file are reported in the output file, BF2\_QB0600\_TEST14.OUT:

$$\begin{aligned} \rho_{Fe} &= \text{DEN}(1) &= 7.8700 \times 10^3 \text{ kg/m}^3, \\ \rho_{FeOH2} &= \text{DEN}(2) &= 3.4000 \times 10^3 \text{ kg/m}^3, \\ \rho_{FeS} &= \text{DEN}(3) &= 4.7000 \times 10^3 \text{ kg/m}^3, \\ \rho_{Cell} &= \text{DEN}(4) &= 1.1000 \times 10^3 \text{ kg/m}^3, \\ \rho_{MgO} &= \text{DEN}(5) &= 3.6000 \times 10^3 \text{ kg/m}^3, \\ \rho_{MgOH2} &= \text{DEN}(6) &= 2.3700 \times 10^3 \text{ kg/m}^3, \\ \rho_{MgCO3} &= \text{DEN}(7) &= 3.0500 \times 10^3 \text{ kg/m}^3, \\ \rho_{SALT} &= \text{DEN}(8) &= 2.1700 \times 10^3 \text{ kg/m}^3. \end{aligned}$$

To test the solids production, results from a waste grid block must be selected. For this test case, there are 4 waste cells with I = 2, 6, 10 and 14. If GROPE is used to extract data from the .CDB file, the waste elements are numbered 6 to 9. At any time after zero, choose a waste grid block, and find the values of the concentration of all the species,  $C_i$ . Using the values for the concentrations, the initial concentrations,  $C_i^0$ , and the densities,  $\rho_i$ , calculate the volume change for species i,  $\Delta V_{si}$ , using equations 9.14.19. Then, using the volume change for species i, calculate the total volume change using equation 9.14.18. The result for the total volume change,  $\Delta V_s$ , should agree to three or four significant figures with the value reported in the BRAGFLO output file under "Normalized volume of solids produced" (PORSOLID in the .CDB file). Values can be checked in as many of the 4 waste grid blocks as necessary to satisfy the testers needs. This verifies Functional Requirement R.23.

*Smooth permeability.*

For Test Case #14, the permeability of materials are smoothly varied in time. This is done on a logarithm basis, since these changes occur over several orders of magnitude. The smoothed permeability,  $k_{smooth}$ , is calculated by:

$$\ln(k_{smooth}) = \ln(k_{init}) + f(t_n) [\ln(k_{final}) - \ln(k_{init})] \tag{9.14.20}$$

$$f(t_n) = (c_1 + c_2 t_n + c_3 t_n^2 + c_4 t_n^3 + c_5 t_n^4 + c_6 t_n^5 + c_7 t_n^6 + c_8 t_n^7) \tag{9.14.21}$$

$$t_n = \begin{cases} 0 & t \leq t_{init} \\ \frac{t - t_{init}}{t_{final} - t_{init}} & t_{init} < t < t_{final} \\ 1 & t \geq t_{final} \end{cases} \quad (9.14.22)$$

$$t_{init} = t_{final} - t_{change} \quad (9.14.23)$$

where

- $k_{init}$  = the initial permeability of the material ( $m^2$ ),
- $k_{final}$  = the final permeability of the material ( $m^2$ ),
- $c_i$  = the eight coefficients in the smoothing function  $f(t_n)$ ,
- $t_n$  = the normalized time factor,
- $t_{init}$  = the time for the permeability change to begin (s),
- $t_{final}$  = the time for the permeability change to end (s),
- $t_{change}$  = the time range for the permeability change (s).

The tester should verify by manual inspection that the following values specified in the input file are reported in the output file, BF2\_QB0600\_TEST14.OUT:

- $k_{init}$  = Kinit =  $1.0000 \times 10^{-11} m^2$ ,
- $k_{final}$  = Kfinal =  $1.0000 \times 10^{-15} m^2$ ,
- $t_{init}$  = Tinit =  $3.1557 \times 10^{10} s$ ,
- $t_{final}$  = Tfinal =  $6.3114 \times 10^{10} s$ ,
- $t_{change}$  = Tchange =  $3.1557 \times 10^{10} s$ ,
- $c_1$  = C1 =  $0.0000 \times 10^0$ ,
- $c_2$  = C2 =  $0.0000 \times 10^0$ ,
- $c_3$  = C3 =  $1.1000 \times 10^1$ ,
- $c_4$  = C4 =  $-5.0000 \times 10^1$ ,
- $c_5$  = C5 =  $1.2000 \times 10^2$ ,
- $c_6$  = C6 =  $-1.6000 \times 10^2$ ,
- $c_7$  = C7 =  $1.1200 \times 10^2$ ,

$$c_8 = C8 = -3.2000 \times 10^1,$$

Because BRAGFLO solves the mass balance equations using a fully implicit technique, all values of dependent variables (gas saturation and brine pressure), as well as all functions of these variables, are valid over the time step just completed. Therefore, the tester can use any reported values at any time for verification simply by inserting the values into the equations above and should find agreement with the results printed to the output file.

To test the smooth permeability model, results from blocks in the material set in the input file must be selected. For this test case, there are 2 cells with I = 18, and 19. If GROPE is used to extract data from the .CDB file, the elements are numbered 18 to 19. At any time after zero, (although the most illustrative points would be between 1,000 and 2,000 years,) choose a block, and find the values of the permeability. Using the values for the time for the permeability change to begin, change and end,  $t_{ini}$ ,  $t_{change}$  and  $t_{final}$ , the eight coefficients in the smoothing function,  $c_i$  (i=1 to 8), and the initial and final permeability of the material,  $k_{ini}$  and  $k_{final}$ , calculate the permeability using equations 9.14.20-23. The result for the permeability,  $k$ , should agree to three or four significant figures with the value reported in the BRAGFLO output file under "Permeability to brine, x-direction" (PERMBRX in the .CDB file), respectively. Values can be checked in as many of the 2 blocks as necessary to satisfy the testers needs. This verifies Functional Requirement R.24.

## 10.0 INSTALLATION AND REGRESSION TESTING

Test Cases #1 through #14 are suitable for installation testing and regression testing.

## 11.0 REFERENCES

1. Stein, J. S., 2004. *Requirements Document and Verification and Validation Plan for BRAGFLO Version 5.0*. Document Version 5.02, ERMS# 536044. Sandia National Laboratories, Albuquerque, NM.
2. Stein, J. S., 2003. *User's Manual for BRAGFLO, Version 5.0*, Document Version 1.30 ERMS# 525702. Sandia National Laboratories, Albuquerque, NM.
3. Nemer, M. B., 2006, *Change Control Form for BRAGFLO, 5.0, (Proposed 6.0)*, ERMS# 544904. Sandia National Laboratories, Albuquerque, NM.
4. Chavez, M. J., 2006. *Procedure NP-19.1, Revision 12, Software Requirements*. ERMS# 543743. Sandia National Laboratories, Albuquerque, NM.
5. WIPP PA (Performance Assessment) Department, 1991. *Preliminary Comparison with 40 CFR 191, Subpart B for the Waste Isolation Pilot Plant, December 1991. Volume 3: Reference Data*. SAND91-0893/3. Sandia National Laboratories, Albuquerque, NM.
6. WIPP PA (Performance Assessment) Department. 1992. *Long-Term Gas and Brine Migration at the Waste Isolation Pilot Plant: Preliminary Sensitivity Analyses for Post-Closure 40, CFR 268 (RCRA)*, May 1992. SAND92-1933. Sandia National Laboratories, Albuquerque, NM.
7. Nemer, M. B., 2007. *Implementation Document for BRAGFLO Version 6.0*. Document Version 1.0, ERMS #545017. Sandia National Laboratories, Albuquerque, NM.
8. Stein, J. S., W. Zelinski, 2004. *Validation Document for BRAGFLO, Version 5.0*. Document Version 5.02, ERMS# 536045. Sandia National Laboratories, Albuquerque, NM.
9. Collins, R. E. 1961. *Flow of Fluids through Porous Materials*. ERMS# 503206. PennWell Publishing Co., Tulsa, OK, p. 118.
10. Philip, J. R. 1955. "Numerical Solution of Equations of the Diffusive Type with Diffusivity Concentration Dependent," *Transactions Faraday Society* 51, 885.
11. Ross, B., J. W. Mercer, S. D. Thomas, and B. H. Lester. 1982. *Benchmark Problems for Repository Siting Models*. NUREG/CR-3097, Reston, VA: Geotrans, Inc.



12. Pruess, K. 1987. TOUGH User's Guide, NUREG/CR-4645, SAND86-7104, LBL-20700, ERMS# 228478, Lawrence Berkeley Laboratory, Berkeley, CA.
13. Updegraff, C. D. 1989. Comparison of Strongly Heat-Driven Flow Codes for Unsaturated Media. SAND88-7145, ERMS# 229005. Albuquerque, NM: Sandia National Laboratories.
14. Moridis, G. J., and K. Pruess. 1992. TOUGH Simulations of Updegraff's Set of Fluid and Heat Flow Problems. LBL-32611, ERMS# 138458. Berkeley, CA: Lawrence Berkeley Laboratory.
15. Vauclin, M., D. Khanji, and G. Vachaud. 1979. "Experimental and Numerical Study of a Transient 2-Dimensional Unsaturated-Saturated Water Table Recharge Problem," *Water Resources Research*. Vol. 15, no. 5, 1089-1101.
16. WIPP PA (Performance Assessment) Department. 1992. *Preliminary Performance Assessment for the Waste Isolation Pilot Plant, December 1992. Volume 3: Model Parameters*. SAND92-0700/3, ERMS# 223529. Sandia National Laboratories, Albuquerque, NM.
17. Bean, J. E., B. M. Butcher, J. W. Garner, J. D. Schreiber, P. N. Swift, and P. Vaughn. 1992. *Uncertainty and Sensitivity Analyses for Gas and Brine Migration at the Waste Isolation Pilot Plant, May 1992*. SAND92-2013, ERMS# 223396. Sandia National Laboratories, Albuquerque, NM.
18. Klinkenberg, L.J., 1941, "The Permeability of Porous Media to Liquids and Gases," ERMS# 208556. *Drilling and Production Prac.*, API, pp. 200-213.
19. Van Genuchten, R., 1978, Calculating the Unsaturated Hydraulic Conductivity with a New Closed-Form Analytical Model, Research Report 78-WR-08, ERMS# 249486. Princeton, NJ: Princeton University, Department of Civil Engineering.
20. Brooks, R. H. and A. T. Corey. 1964, "Hydraulic Properties of Porous Media," ERMS# 241117. *Hydrology Paper No. 3*. Fort Collins, CO: Colorado State University.
21. Walas, S. M. 1985. *Phase Equilibria in Chemical Engineering*. ERMS# 249487. Butterworth Publishers, Boston, MA.
22. Graboski, M. S. and T. E. Daubert. 1979. "A modified Soave equation of state for phase equilibrium calculations. 3: Systems containing hydrogen," ERMS# 251506. *Ind. Eng. Chem. Process Des. Dev.* 18, 300-306.
23. Dake, L. P., *Fundamentals of Reservoir Engineering*. ERMS# 245616. Elsevier Scientific Publishing Company, Amsterdam, 1978.

24. U.S. DOE (U.S. Department of Energy). 1996. "Title 40 CFR 191 Compliance Certification Application for the Waste Isolation Pilot Plant." DOE/CAO-1996-2184. Carlsbad, NM: U.S. Department of Energy, Waste Isolation Pilot Plant, Carlsbad Area Office.